

# NI 5791R

## RF Transceiver Adapter Module

The NI 5791 is an RF transceiver adapter module designed to work in conjunction with your NI FlexRIO™ FPGA module. The NI 5791 features the following connectors and chips:

- 2-channel, 130 MS/s analog-to-digital converter (ADC) with 14-bit accuracy
- 2-channel, 130 MS/s (520 MS/s after interpolation) digital-to-analog converter (DAC) with 16-bit accuracy
- LO input and LO output connectors to support LO sharing for multiple-channel applications
- Timing chip with clocking options from the backplane and the front panel
- Programmable attenuators
- Selectable receive and transmit filters
- The following front panel connectors:
  - RX IN
  - LO OUT
  - CLK IN
  - CLK OUT
  - LO IN
  - TX OUT

The NI 5791 can upconvert and downconvert RF signals ranging from 200 MHz to 4.4 GHz.

This document contains signal information and lists the specifications of the NI 5791R, which is composed of the NI FlexRIO FPGA module and the NI 5791. This document also contains

tutorial sections that demonstrate how to acquire data using a LabVIEW FPGA Example VI and how to create and run your own LabVIEW project with the NI 5791R.



**Note** *NI 5791R* refers to the combination of your NI 5791 adapter module and your NI FlexRIO FPGA module. *NI 5791* refers to your NI 5791 adapter module only.



**Note** The NI 5791 is only compatible with the NI PXIe-796xR FPGA modules.



**Note** Before configuring your NI 5791, you must install the appropriate software and hardware. Refer to the *NI FlexRIO FPGA Module Installation Guide and Specifications* for installation instructions.



**Note** For EMC compliance, operate this device according to the documentation.

The following figure shows an example of a properly connected NI FlexRIO device.

**Figure 1.** NI FlexRIO Device

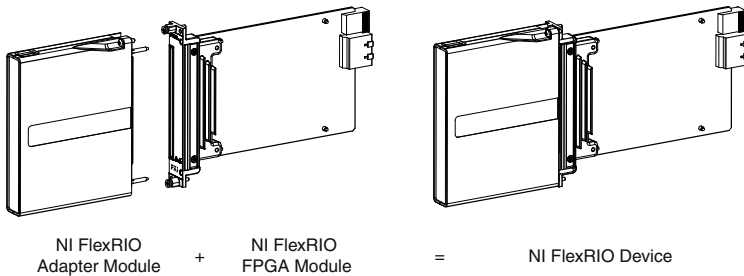

## Related Information

[NI 5791 Specifications](#) on page 21

## Contents

Electromagnetic Compatibility Guidelines.....	3
Connecting Cables.....	4
How to Use Your NI FlexRIO Documentation Set.....	4
Key Features.....	6
Configuration.....	6
Front Panel and Connector Pinouts.....	6
AUX I/O Connector.....	8
Block Diagram.....	9
NI 5791 Component-Level Intellectual Property (CLIP).....	11
5791 CLIP.....	12
Programmable Chips.....	13

Using Your NI 5791R with a LabVIEW FPGA Example VI.....	13
Using the Included Streaming Example.....	14
Creating a LabVIEW Project.....	14
NI-579x Configuration Design Library.....	16
FPGA VI Requirements.....	17
Host VI Requirements.....	17
Synchronization Overview.....	17
Synchronization Versions.....	18
Synchronization Example.....	19
How Synchronization Works.....	19
Synchronization Checklist.....	20
Clocking.....	21
579x Sample Projects.....	21
NI 5791 Specifications.....	21
RX IN.....	22
LO OUT Front Panel Connector.....	27
CLK IN Front Panel Connector.....	28
CLK OUT Front Panel Connector.....	28
LO IN Front Panel Connector.....	29
TX OUT Front Panel Connector.....	29
TX OUT Spurious Responses.....	31
RX IN and TX OUT Frequency Characteristics.....	33
Baseband Characteristics.....	35
AUX I/O (Port 0 DIO <0..3>, Port 1 DIO <0..3>, and PFI <0..3>).....	35
Compliance and Certifications.....	36
Environment.....	37
Installing PXI EMC Filler Panels.....	38
Where to Go for Support.....	39

## Electromagnetic Compatibility Guidelines

---

This product was tested and complies with the regulatory requirements and limits for electromagnetic compatibility (EMC) stated in the product specifications. These requirements and limits are designed to provide reasonable protection against harmful interference when the product is operated in the intended operational electromagnetic environment.

This product is intended for use in industrial locations. However, harmful interference may occur in some installations, when the product is connected to a peripheral device or test object, or if the product is used in residential or commercial areas. To minimize interference with radio and television reception and prevent unacceptable performance degradation, install and use this product in strict accordance with the instructions in the product documentation.

Furthermore, any modifications to the product not expressly approved by National Instruments could void your authority to operate it under your local regulatory rules.



**Caution** To ensure the specified EMC performance, operate this product only with shielded cables and accessories.



**Caution** To ensure the specified EMC performance, the length of all I/O cables must be no longer than 3 m (10 ft).



**Caution** To ensure the specified EMC performance, you must install PXI EMC Filler Panels (National Instruments part number 778700-1) in adjacent chassis slots.

### Related Information

[Installing PXI EMC Filler Panels](#) on page 38

## Connecting Cables

---

1. Use any shielded 50  $\Omega$  SMA cable to connect signals to the connectors on the front panel of your device.
2. Use the SHH19-H19-AUX cable (NI part number: 152629-01 or 152629-02) to connect to the digital I/O (DIO) and programmable function interface (PFI) signals on the AUX I/O connector. NI recommends using the SCB-19 connector block to access the DIO and PFI signals.

### Related Information

[NI 5791 Specifications](#) on page 21

## How to Use Your NI FlexRIO Documentation Set

---

Refer to Figure 2 and Table 1 to learn how to use your FlexRIO documentation set.

**Figure 2.** How to Use Your NI FlexRIO Documentation Set.

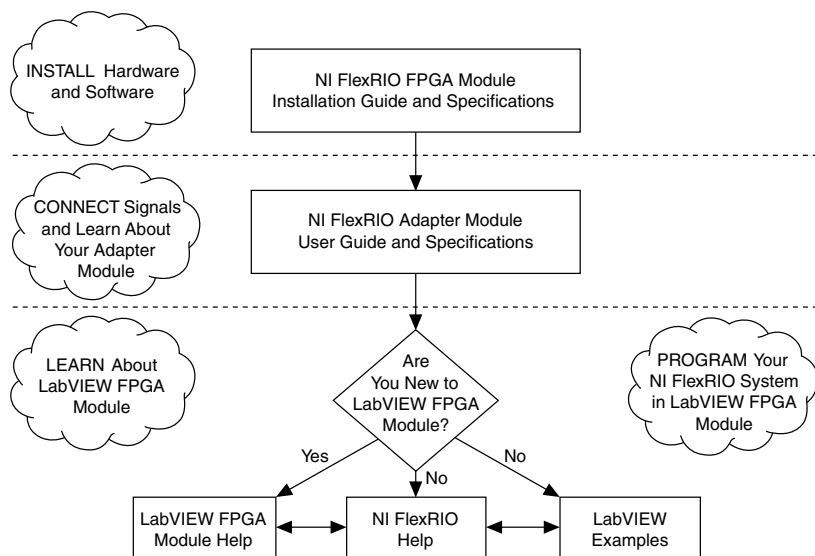

**Table 1.** NI FlexRIO Documentation Locations and Descriptions

Document	Location	Description
<i>NI FlexRIO FPGA Module Installation Guide and Specifications</i>	Available from the Start menu and at <a href="http://ni.com/manuals">ni.com/manuals</a> .	Contains installation instructions for your NI FlexRIO system and specifications for your FPGA module.
<i>NI 5791R User Manual and Specifications</i> (this document)	Available from the Start menu and at <a href="http://ni.com/manuals">ni.com/manuals</a> .	Contains signal information, examples, CLIP details, and specifications for your adapter module.
<i>LabVIEW FPGA Module Help</i>	Embedded in <i>LabVIEW Help</i> and at <a href="http://ni.com/manuals">ni.com/manuals</a> .	Contains information about the basic functionality of the LabVIEW FPGA Module.
<i>NI FlexRIO Help</i>	Available from the Start menu and at <a href="http://ni.com/manuals">ni.com/manuals</a> .	Contains FPGA Module, adapter module, and CLIP configuration information.
LabVIEW Examples	Available in NI Example Finder.	Contains examples of how to run FPGA VIs and Host VIs on your device.

**Table 1.** NI FlexRIO Documentation Locations and Descriptions (Continued)

Document	Location	Description
IPNet	<a href="http://ni.com/ipnet">ni.com/ipnet</a>	Contains LabVIEW FPGA functions and intellectual property to share.
NI FlexRIO product page	<a href="http://ni.com/flexrio">ni.com/flexrio</a>	Contains product information and data sheets for NI FlexRIO devices.

## Key Features

The NI 5791 includes the following key features:

RF frequency range.....	200 MHz to 4.4 GHz
Instantaneous bandwidth.....	100 MHz
ADC.....	14-bit dual channel at 130 MS/s
DAC.....	16-bit dual channel at 130 MS/s, interpolated to 520 MS/s
Phase noise.....	<94 dBc/Hz, 10 kHz offset, 2.4 GHz carrier
Dynamic range.....	>105 dB
Noise figure.....	<8 dB at 2 GHz
EVM.....	<1.5% (RMS)
Receive (RX) IP <sub>3</sub> .....	+1 dBm at 2 GHz
Transmit (TX) IP <sub>3</sub> .....	+17 dBm at 2 GHz

## Configuration

You can configure the NI 5791 as follows:

- Instantaneous bandwidth up to 100 MHz
- 1 transmitter channel, 16-bit, 520 MS/s (4× interpolation) (I and Q)
- 1 receiver channel, 14-bit, 130 MS/s (I and Q)

## Front Panel and Connector Pinouts

Table 2 shows the front panel connector and signal descriptions for the NI 5791.



**Caution** To avoid permanent damage to the NI 5791, disconnect all signals connected to the NI 5791 before powering down the module, and connect signals

only after the adapter module has been powered on by the NI FlexRIO FPGA module.



**Caution** Connections that exceed any of the maximum ratings of any connector on the NI 5791R can damage the device and the chassis. NI is not liable for any damage resulting from such connections.

**Table 2.** NI 5791 Front Panel Connectors

Device Front Panel	Connector	Signal Description
	RX IN	Receive channel input, +20 dBm maximum
	LO OUT	Local oscillator output, +12 dBm maximum, +0 dBm nominal
	CLK IN	Reference Clock input, 50 $\Omega$ single-ended, +20 dBm maximum
	CLK OUT	Exported clock output, DC-coupled, 0 V to 2 V
	LO IN	Local oscillator input, +20 dBm maximum
	TX OUT	Transmit channel output, +20 dBm maximum
	AUX I/O	Refer to Table 3 for the signal list and descriptions.

**Related Information**

[NI 5791 Specifications](#) on page 21

# AUX I/O Connector

**Table 3.** NI 5791 AUX I/O Connector Pin Assignments

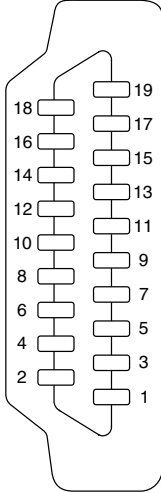
AUX I/O Connector	Pin	Signal	Signal Description
	1	DIO Port 0 (0)	Bidirectional single-ended (SE) digital I/O (DIO) data channel.
	2	GND	Ground reference for signals.
	3	DIO Port 0 (1)	Bidirectional SE DIO data channel.
	4	DIO Port 0 (2)	Bidirectional SE DIO data channel.
	5	GND	Ground reference for signals.
	6	DIO Port 0 (3)	Bidirectional SE DIO data channel.
	7	DIO Port 1 (0)	Bidirectional SE DIO data channel.
	8	GND	Ground reference for signals.
	9	DIO Port 1 (1)	Bidirectional SE DIO data channel.
	10	DIO Port 1 (2)	Bidirectional SE DIO data channel.
	11	GND	Ground reference for signals.
	12	DIO Port 1 (3)	Bidirectional SE DIO data channel.
	13	PFI 0	Bidirectional SE DIO data channel.
	14	NC	No connect.
	15	PFI 1	Bidirectional SE DIO data channel.
	16	PFI 2	Bidirectional SE DIO data channel.
	17	GND	Ground reference for signals.
	18	+5 V	+5 V power (10 mA maximum).
	19	PFI 3	Bidirectional SE DIO data channel.



**Caution** The AUX I/O connector accepts a standard, third-party HDMI cable, but the AUX I/O port is not an HDMI interface. Do not connect the AUX I/O port on the NI 5791 to the HDMI port of another device. NI is not liable for any damage resulting from such signal connections.



# Block Diagram

The following figure shows the NI 5791 block diagram.

**Figure 3. NI 5791 Block Diagram**

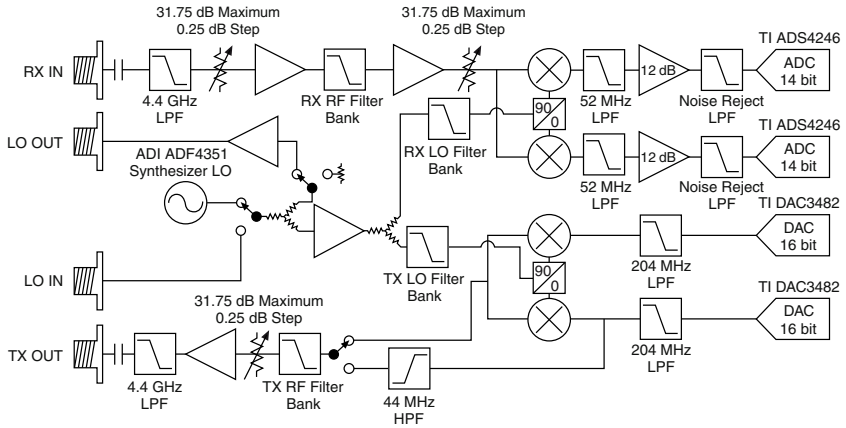

The following figure shows the connections between the NI 5791 and the LabVIEW FPGA CLIP.

**Figure 4. NI 5791 Connector Signals and CLIP Signal Block Diagram**

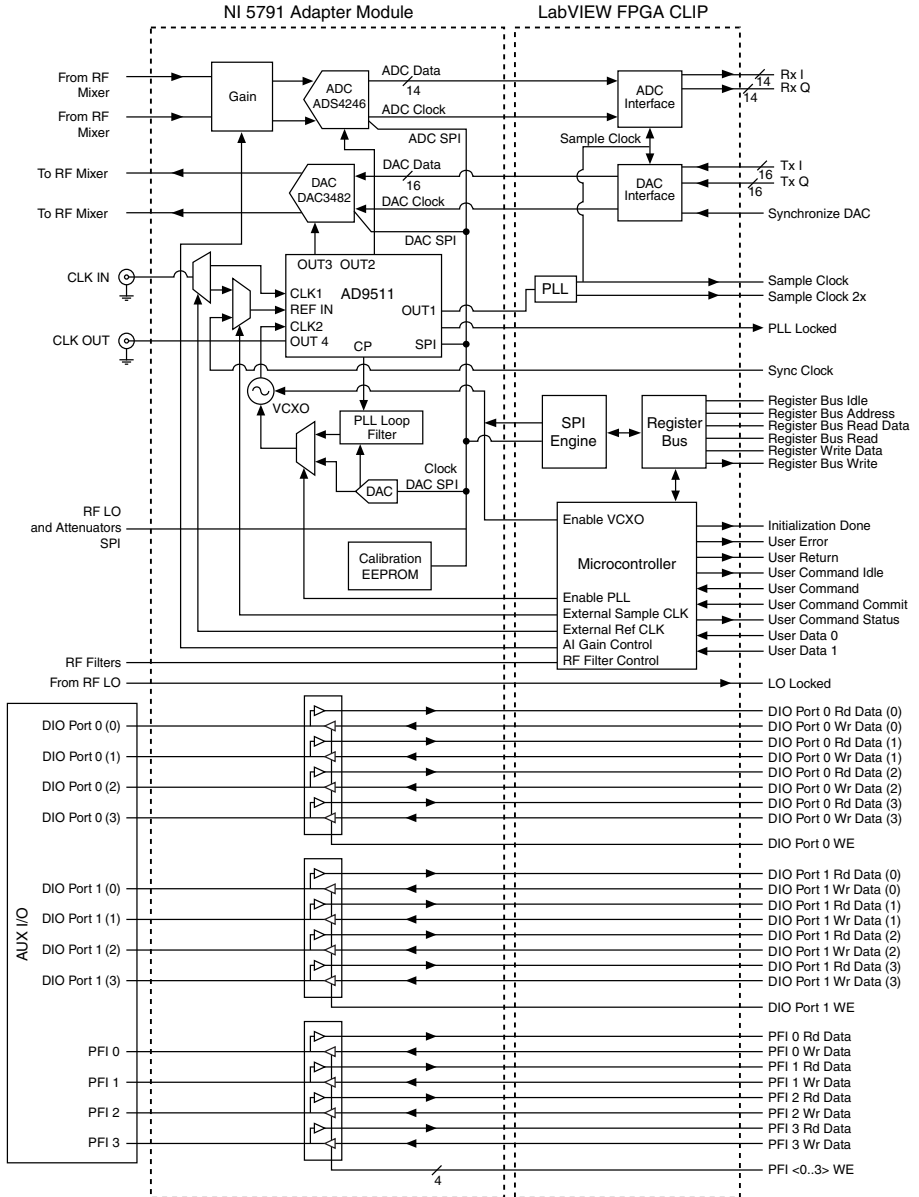

The following figure shows the NI 5791 low-pass filter bank.

**Figure 5. Low-Pass Filter (LPF) Bank**

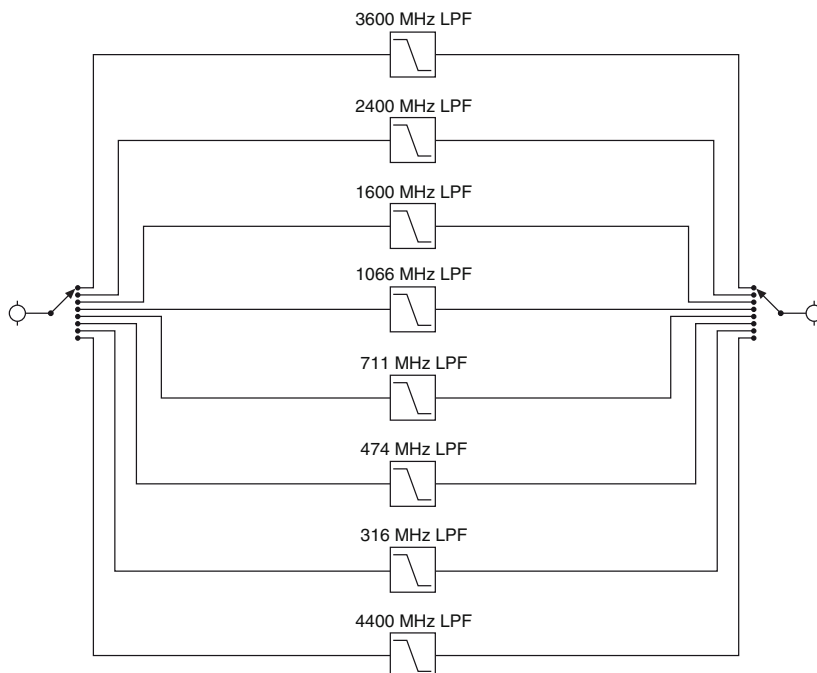

## NI 5791 Component-Level Intellectual Property (CLIP)

The LabVIEW FPGA Module includes component-level intellectual property (CLIP) for HDL IP integration. NI FlexRIO devices support two types of CLIP: user-defined and socketed.

- *User-defined CLIP* allows you to insert HDL IP into an FPGA target, enabling VHDL code to communicate directly with an FPGA VI.
- *Socketed CLIP* provides the same IP integration of the user-defined CLIP, but also allows the CLIP to communicate directly with circuitry external to the FPGA. Adapter module socketed CLIP allows your IP to communicate directly with both the FPGA VI and the external adapter module connector interface.

The following figure shows the relationship between an FPGA VI and the CLIP.

**Figure 6. CLIP and FPGA VI Relationship**

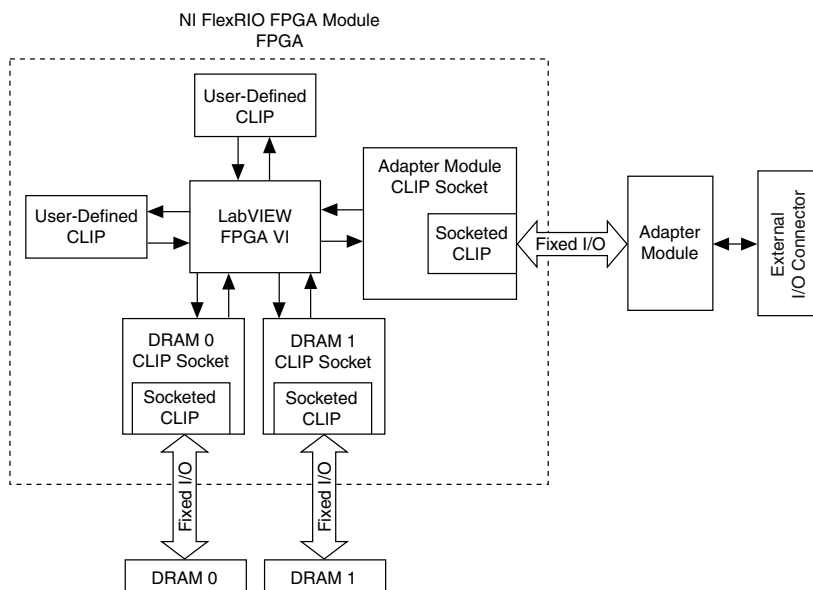

The NI 5791 ships with socketed CLIP items that add module I/O to the LabVIEW project.

## 5791 CLIP

The 5791 CLIP provides access to I and Q data for one receive channel and one transmit channel. The CLIP also provides a User Command interface for common configurations of the baseband clocking, programmable attenuators, receive amplifier, receive and transmit filters, LO filters, and RF path. You can also import and export the LO.

Configure the baseband clocking using one of the following settings:

- Internal Sample Clock
- Internal Sample Clock locked to an external Reference Clock through the CLK IN connector
- External Sample Clock through the CLK IN connector
- Internal Sample Clock locked to an external Reference Clock through the Sync Clock

This CLIP also contains a FAM Registers Bus interface, which is a low-level bus interface that directly programs registers on all programmable devices, such as the analog-to-digital converter (ADC) and the digital-to-analog converter (DAC). Programming registers on these devices allows for more advanced configuration.



**Note** You cannot configure the LO using the User Command interface. Use the FAM Registers Bus interface to program the LO synthesizer, then use the User Command interface to configure the LO filters.

Refer to the *NI FlexRIO Help* for more information about NI FlexRIO CLIP items, configuring the NI 5791 with a socketed CLIP, and a list of available socketed CLIP signals.

# Programmable Chips

You can program the following chips from the CLIP.

**Table 4.** Programmable Chips

Chip	Part Number
ADC	TI ADS4246
DAC	TI DAC3482
Clock Distribution	ADI AD9511
Frequency/Phase Adjust DAC	ADI AD5541
EEPROM	SST25VF080B
Programmable RF Attenuator	Peregrine PE43703

## Using Your NI 5791R with a LabVIEW FPGA Example VI



**Note** You must install the software before running this example. Refer to the *NI FlexRIO FPGA Installation Guide and Specifications* for more information about installing your software.

The NI FlexRIO Adapter Module Support software includes an example project to help you get started creating your LabVIEW FPGA application. This section explains how to use an existing LabVIEW FPGA example project to generate and acquire samples with the NI 5791R. This example requires at least one SMA cable for connecting signals to your NI 5791R.



**Note** The examples available for your device are dependent on the version of the software and driver you are using. For more information about which software versions are compatible with your device, visit [ni.com/info](http://ni.com/info), enter `rdsoftwareversion` in the text field, and click the NI FlexRIO link in the results.

The NI 5791R example project includes the following components:

- A LabVIEW FPGA VI that can be compiled and run on the FPGA embedded in the hardware
- At least one VI that runs on Windows and interacts with the LabVIEW FPGA VI



**Note** In the LabVIEW FPGA Module software, NI FlexRIO adapter modules are referred to as *IO Modules*.

## Using the Included Streaming Example

Complete the following steps to run an example that acquires a waveform using the NI 5791.

1. Connect an antenna to the RX IN connector on the front panel of the NI 5791.
2. Launch LabVIEW.
3. Select **File»Open Project**.
4. Navigate to <labview>\examples\instr\ni579x\Streaming.
5. Select **Streaming.lvproj**.
6. In the **Project Explorer** window, select **Rx Streaming (Host).vi** under **My Computer** to open the host VI. The Open FPGA VI Reference function in this VI uses the NI 7966R as the FPGA target by default. If you are using an NI FlexRIO FPGA module other than the NI 7966R, complete the following steps to change to the FPGA VI to support your target.
  - a) Specify the center frequency in the **LO Frequency [Hz]** control.
  - b) On the block diagram, right-click the Open FPGA VI Reference (PXI-7966R) function and select **Configure Open FPGA VI Reference**.
  - c) In the **Configure Open FPGA VI Reference** dialog box, click the **Browse** button next to the **Bitfile** button.
  - d) In the **Select Bitfile** dialog box that opens, select the bitfile for your desired target. The bitfile name is based on the adapter module, example type, and FPGA module.
  - e) Click the **Select** button.
  - f) Click **OK** in the **Configure Open FPGA VI Reference** dialog box.
  - g) Save the VI.
7. On the front panel, in the **RIO Device** pull-down menu, select an NI 5791 resource that corresponds with the target configured in step 6.
8. Configure your measurement.
  - a) Specify the center frequency in the **LO Frequency [Hz]** control.
  - b) Specify the reference level in the **Reference Level [dBm]** control.
  - c) Specify the sample rate in the **Sample Rate [S/s]** control.
9. Click the **Run** button to run the VI.
10. The VI acquires data and displays the captured waveform on the **Power Level, Power Spectrum, and I & Q Data** graphs.
11. Click the **STOP** button to stop the VI.
12. Close the VI.

## Creating a LabVIEW Project

This section explains how to set up your target and create an FPGA VI and host VI for data communication. This section focuses on proper project configuration, proper CLIP configuration, and how to access NI 5791 I/O nodes.

### Creating a Project

1. Launch LabVIEW, or if LabVIEW is already running, select **File»Create Project**.
2. In the **Create Project** dialog box, select **LabVIEW FPGA Project** and click **Finish**.
3. Select **FlexRIO on My Computer** and click **Next**.

4. Either discover a LabVIEW FPGA target in your system or create a new system and specify an FPGA target for which to construct a project.
5. Click **Finish** in the **Project Preview** dialog box.
6. Click **File»Save** and specify a name for the project.

## Creating an FPGA Target VI

1. In the **Project Explorer** window, expand **FPGA Target**.
2. Right-click **FPGA Target** and select **New»FPGA Base Clock**.
3. In the **Resource** pull-down menu, select **200 MHz Clock** and click **OK**.
4. Right-click **IO Module** in the **Project Explorer** window and select **Properties**.
5. Select **Enable IO Module**.
6. Select the NI 5791 from the **IO Module** list. The available CLIP for the NI 5791 is displayed in the **Component Level IP** pane.
7. Select NI 5791 in the **Name** list of the **Component Level IP** pane.
8. In the **Clock Selections** category, select **200 MHz Clock** from the pull-down menu for **Clock 200 MHz**. Leave **Clock 40 MHz** configured as the **Top-Level Clock**.
9. Click **OK**.



**Note** Configuring these clocks is required for proper CLIP operation. Refer to the NI 5791 CLIP topics in the *NI FlexRIO Help* for more information about configuring your clocks.

10. Select **File»Open** and select `<labview>\instr.lib\ni579x\config\v1\FPGA\Public\ni579x Config FPGA Template.vi`.
11. Select **File»Save As**.
12. Select **Copy»Open Additional Copy** and check **Add Copy to <your project name>.lvproj**.
13. Select the destination folder for the new file, specify a file name, and click **OK**. Use this FPGA VI with the NI-579x Configuration Design Library.
14. In the **Project Explorer** window, expand **IO Module Tree View**. Use any of the elements under **IO Module (NI 5791 : NI 5791)** in the block diagram of the FPGA VI.



**Note** Use Rx I, Rx Q, Tx I, and Tx Q in a single-cycle Timed Loop using the Sample Clock provided by the CLIP. Sample Clock x2 runs at twice the rate of the Sample clock. The DSP and Synchronization Design Libraries use Sample Clock x2.

15. Add any FPGA code, controls, and indicators that you need. Refer to `streaming.lvproj` for example FPGA code, controls, and indicators.
16. Click the **Run** button. LabVIEW creates a default build specification and begins compiling the VI. The **Generating Intermediate Files** window displays the code generation process. The **Compilation Status** window displays the progress of the compilation. The compilation takes several minutes.
17. Click **Close** in the **Compilation Status** window.
18. Save and close the VI.
19. Save the project.

## Creating a Host VI

1. In the **Project Explorer** window, right-click **My Computer** and select **New»VI** to open a blank VI.
2. Select **Window»Show Block Diagram** to open the VI block diagram.
3. Add the Open FPGA VI Reference function from the FPGA Interface palette to the block diagram.
4. Right-click the Open FPGA VI Reference function and select **Configure Open FPGA VI Reference**.
5. In the **Configure Open FPGA VI Reference** dialog box, select **VI** in the **Open** section.
6. In the **Select VI** dialog box, select your project under your device and click **OK**.
7. Click **OK** in the **Configure Open FPGA VI Reference** dialog box. The target name appears under the Open FPGA VI Reference function in the block diagram.
8. Open the FPGA Interface palette.
9. Add any Read/Write Control or Invoke Method nodes necessary to configure and communicate with your FPGA VI.
10. Add the Close FPGA VI Reference function to your block diagram.
11. Wire the FPGA VI Reference function to the Close FPGA VI Reference function.
12. Save and close the VI.
13. Save the project.

## Run the Host VI

1. Open the front panel of your host VI.
2. Click the **Run** button to run the VI.

## NI-579x Configuration Design Library

---

The NI-579x Configuration Design Library consists of host and FPGA VIs that provide an interface to configure the hardware on the NI 5791.

The library allows you to perform the following actions:

- Configure the mixers
- Configure the RF signal path, including attenuators, amplifiers, and filters
- Read from and write to the EEPROM
- Configure the reference level for the Rx channel and the output power for the Tx channel
- Configure the clocks
- Reinitialize the CLIP
- Query for CLIP errors

The NI-579x Configuration Design Library relies on the Register Bus Design Library. The Register Bus provides a packet-based configuration interface which exposes all of the address spaces of the configurable chips and subsystems of the adapter module, without requiring hundreds of controls and indicators on your FPGA VI front panel.



The NI-579x Configuration Design Library host VIs all require a register bus object for the device you want to configure. Create the register bus object using `Open Session.vi`, or use `ni579x Open.vi`.

For more information about how to use the NI-579x Configuration Design Library, refer to the example located at `<labview>\examples\instr\ni579x\Streaming\Streaming.lvproj`.

## FPGA VI Requirements

Copy all the controls, indicators, and FPGA logic required to use the NI-579x Configuration Design Library from the following VI: `<labview>\instr.lib\ni579x\Config\vl\FPGA\Public\ni579x Config FPGA Template.vi`. The FAM Support installer installs this VI on your system.

Configure your FPGA target to contain a FIFO with the following configuration.

- Name: `reg.host instruction fifo 0`
- Type: Host to Target - DMA
- Requested number of elements: 1,023
- Data type: U64
- Arbitration for read: Arbitrate if multiple requestors only
- Number of elements per read: 1

## Host VI Requirements

Configure your host VI to use the NI-579x Configuration Design Library using the following configuration:

1. Create a Register Bus object for your device and initialize the session using `ni579x Open.vi`.
2. Use any of the NI-579x Configuration Design Library Host VIs using the Register Bus object returned by the `ni579x Open VI`.
3. To access the Host VIs, select **Functions»Instrument I/O»Instrument Drivers»NI-579x Configuration**.
4. Close the session using the `ni579x Close VI`.

## Synchronization Overview

---

Synchronization coordinates Sample Clock cycles across multiple NI FlexRIO devices. Sources of error, such as common clock propagation delay, cabling and cable lengths, analog delays in the FPGA module and/or adapter module, and skew/jitter in the common clock, can affect frequency and phase relationships between devices.

Use the programming example to synchronize across multiple NI FlexRIO adapter modules.

Synchronization aligns the devices so that the devices are synchronized to the nearest Sample Clock cycle. The devices may be offset by up to one half of one Sample Clock cycle, if the

devices are  $\pm 180$  degrees out of phase. If the devices are zero degrees out of phase, device alignment offset is also zero degrees.



**Note** For the best synchronization results, minimize the phase offset between devices.



**Caution** Before attempting to synchronize your NI FlexRIO devices, notice the following caveats:

- Synchronization does not account for differences in analog signal paths.
- Synchronization does not account for data pipeline delays that occur before and after the synchronization VIs. For example, synchronization does not account for ADC/DAC pipeline delays.
- The synchronized edge is always delayed relative to the unsynchronized edge. The application is responsible for accounting for this delay, if necessary. The synchronization VIs provide the actual synchronization delay value.
- Lock all devices to a common time reference. Use the Reference Clock as the time reference.
- Set the synchronization registers for the Reference Clock to zero.
- Synchronization does not account for propagation delays of the Reference Clock.
- All Sample Clocks must have a fixed phase relationship with each other.
- The Common Periodic Time Reference (CPTR) period must be greater than the maximum propagation delay of a signal from the master device to any slave device across the selected FPGA I/O line.
- The CPTR period must be the same across all devices. Devices can have different Sample Clock frequencies if the device Sample Clocks have a fixed phase relationship.
- Route the FPGA I/O lines to all the devices that you are synchronizing.

## Synchronization Versions

The synchronization library provides two alignment methods depending on user needs: FPGA self-synchronization and host-driven synchronization. Both synchronization methods produce the same quality of synchronization, but differ in their requirements and versatility of operation.

### FPGA Self-Synchronization

FPGA self-synchronization does not require host involvement. Using the host VIs is optional. The FPGAs can all independently align their CPTRs. To perform a self-synchronization, your devices must meet the following requirements:

- Sample Clocks are locked to the same Reference Clock.
- Sample Clocks are an integer multiple of the Reference Clock.
- All the devices are fewer than 90 degrees out-of-phase with each other.



**Note** FPGA self-synchronization is repeatable only if the devices meet all the requirements. If the devices do not meet the requirements, use host-driven synchronization.

## Host-Driven Synchronization

Host-driven synchronization allows you to perform the following actions:

- Decouple the Sample Clock and the Reference Clock
- Use an external Sample Clock
- Set the CPTR period manually

Host-driven synchronization requires an additional FPGA I/O line and host involvement for CPTR alignment.



**Note** Host-driven synchronization is repeatable only if the phase relationships between devices remain constant.

Host-driven synchronization guarantees that the maximum phase offset between the master and slave device is one-half of a Sample Clock period. The phase offset approaches zero as the phase relationships between the devices approach zero.



**Note** The phase relationship between the device and the Reference Clock does not affect host-driven synchronization.

## Synchronization Example

You can find examples of both FPGA code and host code for synchronization at `<labview>\examples\instr\ni579x\Streaming`.

## How Synchronization Works

When you share triggers between multiple devices, propagation delays on the signal path cause the trigger to arrive at different times on each device. The synchronization library uses the CPTR to slow down the trigger evaluation rate. All devices must produce a CPTR signal that is equal in frequency and phase-aligned.

The synchronization FPGA VIs produce and align a CPTR that occurs simultaneously across all the FPGAs. The CPTR is periodic, and the Sample Clock rate controls the CPTR period.

When you power on the FPGAs, the CPTRs are not aligned. The alignment FPGA VI and the host VI align the CPTRs. The following figure shows the relationship between the CPTRs, the Reference Clock, and the Sample Clock.

**Figure 7. CPTR Alignment**

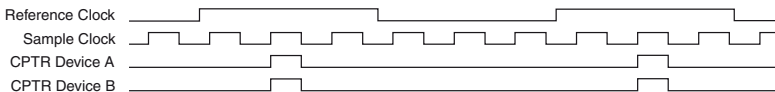

**Note** Lock Device A and Device B to a common clock.

Once the CPTRs are aligned, synchronize an edge across multiple FPGAs. The master device distributes the signal across an FPGA I/O line. All devices monitor the same FPGA I/O line.

The edge is synchronized at the next CPTR edge. After all the device CPTRs are aligned, an edge sent out on the FPGA I/O lines is read at the same clock cycle across all the devices.



**Note** The quality of synchronization is only as good as the quality of Sample Clock locking. Some static skew may exist. You can calibrate to eliminate this skew if necessary.

The following figure shows the relationship between the time that the master device reads a Reference Trigger (*Ref Trig*) and the time that all the devices read the synchronized version of the Reference Trigger (*Synchronized Ref Trig*). This synchronization requires CPTR alignment on all the devices.

**Figure 8. Reading the Reference Triggers**

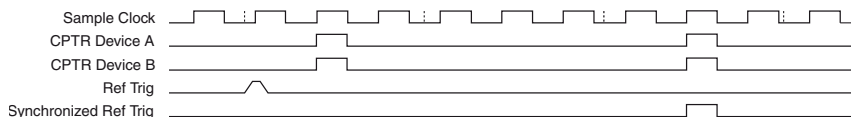

## Synchronization Checklist

Verify that the project settings in the system, the project, the host VI, and the FPGA VI are configured as follows.

- System settings:
  - Route the FPGA I/O lines to all the devices.
  - Depending on your chassis size, you may have to route PXI trigger lines using Measurement & Automation Explorer (MAX). Refer to the *Measurement & Automation Explorer (MAX) Help* at [ni.com/manuals](http://ni.com/manuals) for more information about routing PXI trigger lines with MAX.
- Project settings:
  - Configure the adapter module IoModSyncClock (either PXI\_CLK10 or DStarA) if you are not driving the adapter module CLK IN connector.
  - Add the FPGA Reference Clock.
  - Configure the Reference Clock to have zero synchronization registers. In the **FPGA IO Property** dialog box, set **Number of Synchronization Registers for Read** to 0.
  - Add the FPGA I/O lines that you are synchronizing. Do not remove synchronization registers.
- Host VI:
  - Configure the adapter module clock source based on the project settings.
  - Lock the adapter module clock to the clock source.

- Run the Synchronization VI.
- Refer to the example FPGA code at  
`<labviewdir>\examples\instr\ni579x\Streaming.`
- FPGA VI:
  - Configure the CPTR period. The synchronization library ensures that the CPTR period is the same on the host and the FPGA.
  - Refer to the example FPGA code at  
`<labviewdir>\examples\instr\ni579x\Streaming.`

## Clocking

---

The NI 5791 clock source controls the sample rate and other timing functions on the device. The following table contains information about the possible NI 5791 clock sources.

**Table 5.** NI 5791R Clock Sources

Clock	Frequency	Source Options
Sample Clock	130 MHz	<ul style="list-style-type: none"> <li>• Free-running and internally sourced</li> <li>• External through the CLK IN front panel connector</li> </ul>
Reference Clock	10 MHz	<ul style="list-style-type: none"> <li>• Free-running and internally sourced</li> <li>• External through the CLK IN front panel connector</li> <li>• Sourced through PXI-CLK</li> </ul>

## 579x Sample Projects

---

The NI 5791 software contains sample projects that are a starting point for application development. The projects are available in LabVIEW under **Create Project»Sample Projects»NI-579X**.

## NI 5791 Specifications

---

Specifications are warranted by design and under the following conditions unless otherwise noted:

- Chassis fan speed is set to High. In addition, NI recommends using slot blockers and EMC filler panels in empty module slots to minimize temperature drift.
- The NI 5791 uses NI LabVIEW and LabVIEW FPGA software.

National Instruments RF devices are capable of acquiring and/or generating signals within common Medical Implantable Communication System (MICS) frequency bands. NI RF devices are tested and verified in manufacturing for several measurements. For more

information about RF device applications, visit to contact a National Instruments branch office.

*Specifications* describe the warranted product performance over ambient temperature ranges of 0 °C to 55 °C, unless otherwise noted.

Specifications are subject to change without notice. For the most recent device specifications, visit [ni.com/manuals](http://ni.com/manuals).

*Typical* values describe useful product performance beyond specifications that are not covered by warranty and do not include guardbands for measurement uncertainty or drift. Typical values may not be verified on all units shipped from the factory. Unless otherwise noted, typical values cover the expected performance of units over ambient temperature ranges of 23 °C ± 5 °C with a 90% confidence level, based on measurements taken during development or production.

*Nominal* values (or supplemental information) describe additional information about the product that may be useful, including expected performance that is not covered under *Specifications* or *Typical* values. Nominal values are not covered by warranty.

### Related Information

[Front Panel and Connector Pinouts](#) on page 6

[Connecting Cables](#) on page 4

[NI 5791 User Manual and Specifications](#) on page 1

## RX IN

### Amplitude Range

RX input attenuation.....0 dB to 63.5 dB in 0.25 dB steps, 6 μs switch time

### Absolute Amplitude Accuracy





**Note** All values are typical.

**Table 6.** Absolute Amplitude Accuracy

Center Frequency	Absolute Amplitude Accuracy, Temperature 23 °C ± 5 °C (dB)
>200 MHz to 1 GHz	0.55
>1 GHz to 2 GHz	0.55
>2 GHz to 3 GHz	0.65

**Table 6.** Absolute Amplitude Accuracy (Continued)

Center Frequency	Absolute Amplitude Accuracy, Temperature 23 °C ± 5 °C (dB)
>3 GHz to 3.9 GHz	1.3
>3.9 GHz to 4.4 GHz	1.5
 <b>Note</b> Absolute amplitude accuracy uses a correction coefficient in EEPROM to improve performance. Performance is verified over the first 45 dB of RX attenuation.	
 <b>Note</b> Correction coefficients in EEPROM are valid only when the baseband amplifier is in the signal path.	

## Noise Density

**Table 7.** Noise Density

Center Frequency	Average Noise Level (dBm/Hz), Temperature 23 °C ± 5 °C
>200 MHz to 1 GHz	-163
>1 GHz to 2 GHz	-163
>2 GHz to 3 GHz	-162
>3 GHz to 3.5 GHz	-160
>3.5 GHz to 3.9 GHz	-158
>3.9 GHz to 4.4 GHz	-148
 <b>Note</b> Performance is measured with an input reference level of -48 dBm and with 0 dB of RX attenuation.	

**Figure 9. Noise Density**

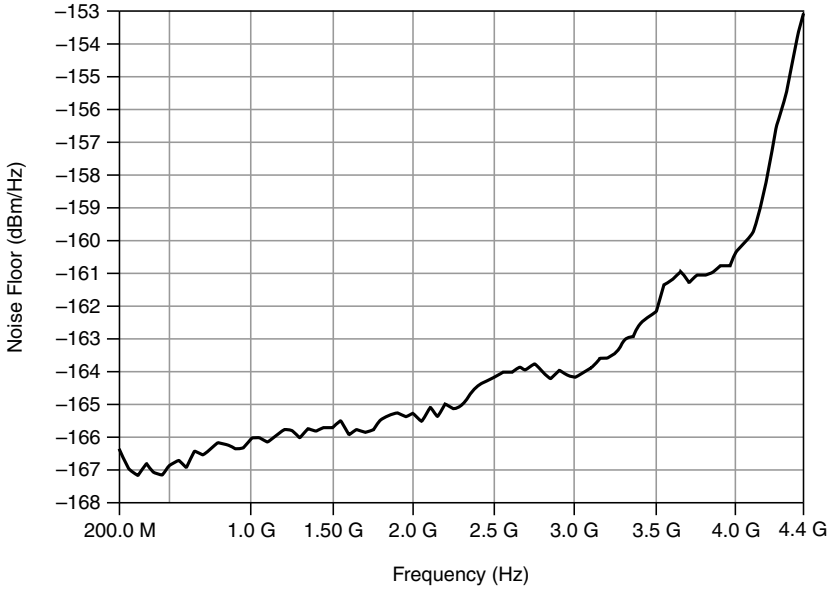

**Table 8. Gain Compression (Nominal)**

Frequency	Gain Compression, Temperature 23 °C ± 5 °C (dBm)
>200 MHz to 1 GHz	-20
>1 GHz to 2 GHz	-18
>2 GHz to 3.9 GHz	-15
>3.9 GHz to 4.4 GHz	-12

 **Note** Values are based on stimulus of two input tones spaced 100 MHz apart, with 0 dB of RX attenuation on the receive path and with one tone placed out of band.

### Voltage Standing Wave Ratio (VSWR)

 **Note** All values are nominal.

Input impedance.....50 Ω



Input VSWR with 10 dB of RX attenuation

<1.3 GHz.....	1.5:1
1.3 GHz <math><f</math> <math>< 3\text{ GHz}</math>.....	1.1:1
>3 GHz.....	1.9:1

## Spurious Responses



**Note** All responses are typical.

Non-input-related residual spurs

<3 GHz.....	<-101 dBm
3 GHz to 3.9 GHz.....	<-100 dBm
≥3.9 GHz.....	<-91 dBm



**Note** Performance is measured with 0 dB of RX attenuation and a 1.5 kHz resolution bandwidth (RBW).

## RX LO Residual Power



**Note** All values are nominal.

**Table 9.** Receiver LO Residual Power

Center Frequency	Residual Power, Temperature 23 °C ± 5 °C (dBFS)
>200 MHz to 1 GHz	-42
>1 GHz to 2 GHz	-52
>2 GHz to 3 GHz	-52
>3 GHz to 3.9 GHz	-52
>3.9 GHz to 4.4 GHz	-52



**Note** Receiver LO suppression is measured at the same RX attenuation after an I/Q correction.

## RX Sideband Image Suppression



**Note** All values are nominal.

**Table 10.** Sideband Image Suppression

Center Frequency	Temperature 23 °C ± 5 °C (dBc)
>200 MHz to 1 GHz	-39
>1 GHz to 2 GHz	-58
>2 GHz to 3 GHz	-54
>3 GHz to 3.9 GHz	-45
>3.9 GHz to 4.4 GHz	-35
 <b>Note</b> The image suppression specifications hold at the center frequency of the acquired instantaneous bandwidth after the device performs a single recent point I/Q impairment self-correction.	

### RX Third Order Intermodulation Distortion (IP<sub>3</sub>)

 **Note** All values are nominal.

**Table 11.** RX IP<sub>3</sub>

Frequency	Temperature 23 °C ± 5 °C (dBm)
>200 MHz to 1 GHz	-2
>1 GHz to 2 GHz	-1
>2 GHz to 3 GHz	0
>3 GHz to 3.9 GHz	1
>3.9 GHz to 4.4 GHz	1
 <b>Note</b> Values are based on two input tones spaced 1 MHz apart such that the tones are 6 dB less than full-scale with 0 dB of RX attenuation.	

### Dynamic Range

 **Note** All values are nominal.

**Table 12.** Dynamic Range at 900 MHz

Reference Level (dBm)	IP <sub>3</sub> (dBm)	Noise Floor (dBm/Hz)	Dynamic Range (dB)
5	24	-135	106
-5	14	-145	106
-15	4	-155	106
-25	0	-163	109



**Note** The signal level of each tone is set to 6 dB less than the reference level to prevent overload. Dynamic range =  $2/3 \times (IMD_3 - Noise Floor)$

**Table 13.** Dynamic Range at 2,400 MHz

Reference Level (dBm)	IP <sub>3</sub> (dBm)	Noise Floor (dBm/Hz)	Dynamic Range (dB)
5	22	-135	105
-5	12	-145	105
-15	3	-155	105
-25	1	-163	109



**Note** The signal level of each tone is set to 6 dB less than the reference level to prevent overload. Dynamic range =  $2/3 \times (IP_3 - Noise Floor)$

## LO OUT Front Panel Connector

Frequency range.....200 MHz to 4.4 GHz

Frequency resolution.....1,000 kHz

Output power

<2.4 GHz.....0 dBm ± 3 dB, nominal

≥2.4 GHz.....-3 dBm ± 3 dB, nominal

Output impedance.....50 Ω, nominal

Output VSWR.....1.78:1

Amplitude settling time.....<0.25 dB in <10 ms, typical

Maximum DC voltage.....±0.5 V<sub>DC</sub>

**Figure 10. LO Output Power**

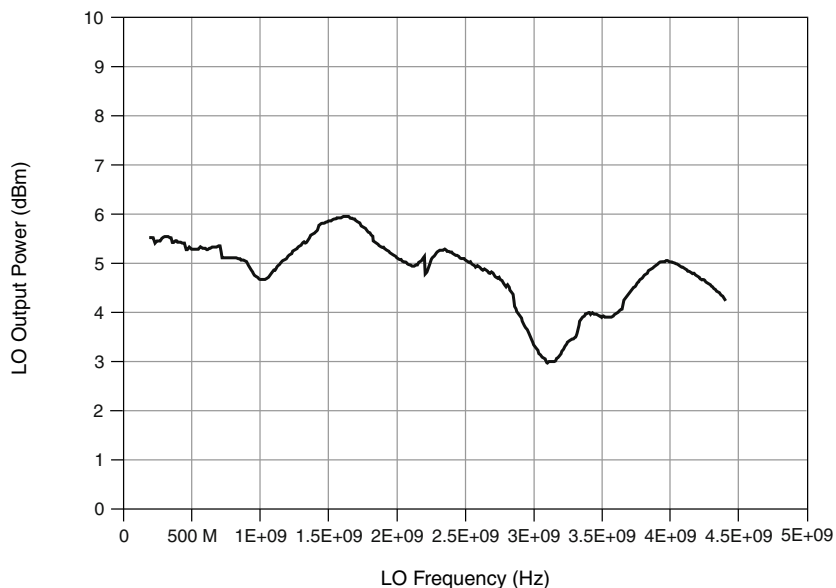

**Note** For frequencies above 2.8 GHz, the gain is <0 dB. The NI 5791 can daisy chain up to eight channels of adapter modules below 2.8 GHz without external amplification. For frequencies above 2.8 GHz, NI recommends using external LO distribution amplifiers if more than two adapter modules share LOs.

## CLK IN Front Panel Connector

### Frequency

Reference Clock.....10 MHz

Sample Clock.....130 MHz

### Amplitude

Square.....0.7 V<sub>pk-pk</sub> to 5.0 V<sub>pk-pk</sub> into 50 Ω, typical

Sine.....1.4 V<sub>pk-pk</sub> to 5.0 V<sub>pk-pk</sub> (1 V<sub>RMS</sub> to 3.5 V<sub>RMS</sub>)  
into 50 Ω, typical

Input impedance.....50 Ω, nominal

Coupling.....AC

## CLK OUT Front Panel Connector

Interface standard.....3.3 V LVCMOS

## Interface logic

Maximum $V_{OL}$ .....	0.55 V
Minimum $V_{OH}$ .....	2.7 V
Maximum $V_{OH}$ .....	3.6 V
Output impedance.....	50 $\Omega$ $\pm$ 20%
Coupling.....	DC
$I_{out}$ (DC).....	$\pm$ 32 mA

## LO IN Front Panel Connector

Frequency range.....200 MHz to 4.4 GHz

### Input power

<2.4 GHz.....	3 dBm $\pm$ 3 dB, nominal
$\geq$ 2.4 GHz.....	0 dBm $\pm$ 3 dB, nominal

Input impedance.....50  $\Omega$

Input VSWR.....1.78:1

Absolute maximum power.....+15 dBm

Maximum DC power..... $\pm$ 0.5  $V_{DC}$

## TX OUT Front Panel Connector

## Amplitude Characteristics

### Power range

Output.....	Noise floor to +8 dBm, nominal
Output resolution.....	0.25 dB, nominal
Amplitude settling time.....	<0.5 dB within 1 ms, nominal

## Absolute Amplitude Accuracy



**Note** All values are typical.

**Table 14.** Absolute Amplitude Accuracy

Frequency	Temperature 23 °C $\pm$ 5 °C (dB)
>200 MHz to 1 GHz	0.8
1 GHz to 2 GHz	1.3
2 GHz to 3 GHz	1.3

**Table 14.** Absolute Amplitude Accuracy (Continued)

Frequency	Temperature 23 °C ±5 °C (dB)
3 GHz to 4.4 GHz	1.8

 **Note** Absolute amplitude accuracy uses a correction coefficient in EEPROM to improve performance. The TX amplitude accuracy applies to the output power level from -12 dBm to -4 dBm.

**Figure 11.** TX Output Power

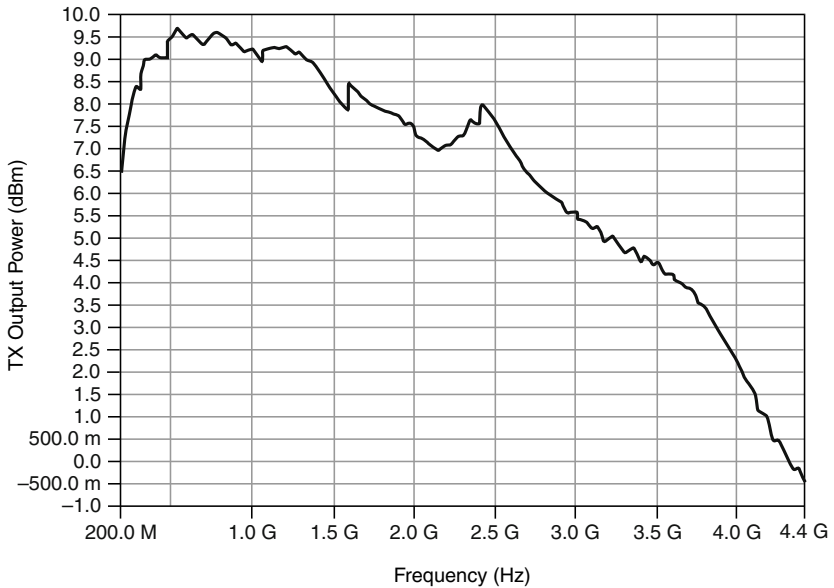

## Noise Density



**Note** All values are typical.

**Table 15.** Noise Density

Frequency	Temperature 23 °C ±5 °C (dBm/Hz)
>200 MHz to 1 GHz	-138
>1 GHz to 2 GHz	-138

**Table 15.** Noise Density (Continued)

Frequency	Temperature 23 °C ±5 °C (dBm/Hz)
>2 GHz to 3 GHz	-130
>3 GHz to 4.4 GHz	-130

 **Note** Performance is measured with 0 dB of TX attenuation.

## Output Voltage Standing Wave Ratio (VSWR)

<2.0 GHz..... 1.6:1

≥2.0 GHz and <3.0 GHz..... 1.4:1

≥3.0 GHz..... 1.7:1

 **Note** The VSWR is measured with 10 dB of TX attenuation.

## TX OUT Spurious Responses

### Third Order Intermodulation (IP<sub>3</sub>)

 **Note** All values are typical.

**Table 16.** IP<sub>3</sub>

Frequency	Temperature 23 °C ± 5 °C (dBm)
>200 MHz to 1 GHz	19
>1 GHz to 2 GHz	17
>2 GHz to 3 GHz	13
>3 GHz to 3.9 GHz	11
>3.9 GHz to 4.4 GHz	8

 **Note** Values are based on two input tones spaced 1.3 MHz apart with 5 dB of TX attenuation.

## Second Order Intermodulation (IP<sub>2</sub>)



**Note** All values are typical.



**Note** All values are typical.

**Table 17.** IP<sub>2</sub>

Frequency	Temperature 23 °C ±5 °C (dBm)
>200 MHz to 1 GHz	25
>1 GHz to 2 GHz	25
>2 GHz to 3 GHz	25
>3 GHz to 4.4 GHz	35

 **Note** Values are based on two input tones spaced 1.3 MHz apart with 5 dB of TX attenuation.

## TX Sideband Image Suppression



**Note** All values are nominal.

**Table 18.** Image Suppression

Frequency	Temperature 23 °C ±5 °C (dBc)
>200 MHz to 1 GHz	-50
>1 GHz to 2 GHz	-50
>2 GHz to 3 GHz	-50
>3 GHz to 4.4 GHz	-45

 **Note** The image suppression specifications hold at the center frequency of the transmitted instantaneous bandwidth after the device performs a recent single point I/Q impairment self-correction.

## TX LO Residual Power



**Note** All values are typical.



**Table 19. TX LO Residual Power**

Frequency	Temperature 23 °C ±5 °C (dBm)
>200 MHz to 1 GHz	-48
>1 GHz to 2 GHz	-48
>2 GHz to 3 GHz	-48
>3 GHz to 4.4 GHz	-45

 **Note** This specification holds at the center frequency of the transmitted instantaneous bandwidth, 100 MHz maximum after the device performs a recent single point I/Q impairment self-correction. The measurement is performed with 0 dB of TX attenuation.

## RX IN and TX OUT Frequency Characteristics

Frequency range.....200 MHz to 4.4 GHz

Instantaneous bandwidth.....100 MHz

Tuning resolution<sup>1</sup>.....<250 kHz

LO step size<sup>2</sup>

Integer mode.....4 MHz, 6 MHz, 12 MHz, 24 MHz step sizes

Fractional mode.....100 kHz step size

## Frequency Settling Time

Settling time<sup>3</sup>.....<100 μs per 50 MHz step

<sup>1</sup> Tuning resolution combines LO step size capability and frequency shift DSP implemented on the FPGA.

<sup>2</sup> Enable fractional mode and use a 100 kHz LO step size with all LO step size specifications.

<sup>3</sup> This settling time specification only includes frequency settling time, and it excludes any residual amplitude settling that may occur as a result of large frequency changes. Driver and operating system timing can affect transition times. This specification reflects only hardware settling.

# Phase Noise (Nominal)

**Table 20.** Phase Noise at 2.4 GHz

Offset Frequency	Phase Noise (dBc/Hz)
1 kHz	-90
10 kHz	-94
100 kHz	-104
1 MHz	-130
10 MHz	-140

**Figure 12.** Phase Noise (900 MHz, 2.4 GHz, 4.4 GHz)

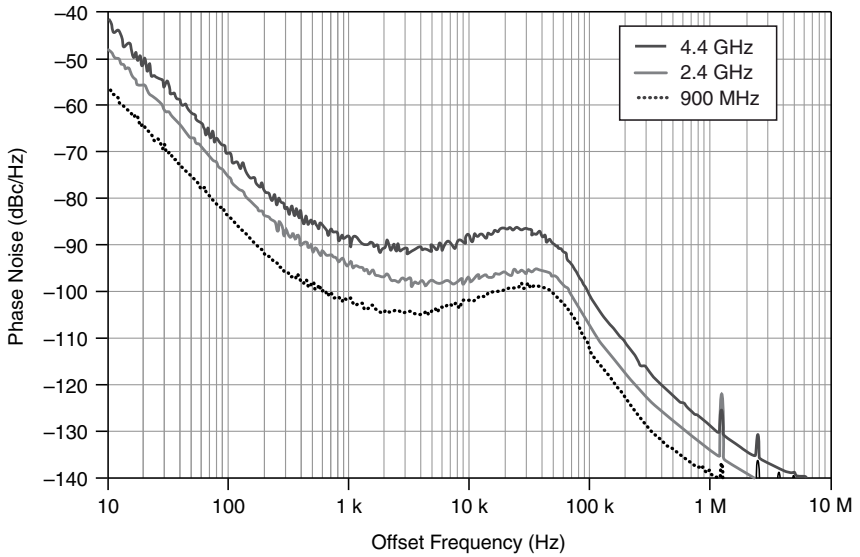

# Baseband Characteristics

## ADC (TI ADS4246)<sup>4</sup>

Resolution.....	14 bits
Data rate.....	130 MS/s <sup>5</sup>
Samples per cycle.....	1

## DAC (TI DAC3482)

Resolution.....	16 bits
Data rate.....	130 MS/s (automatically interpolated to 520 MS/s)
Samples per cycle.....	1

# Dimensions and Weight

Dimensions.....	12.9 × 2.0 × 12.1 cm (5.1 × 0.8 × 4.7 in)
Weight.....	413 g (14.6 oz)
I/O.....	RX in, RX out, LO in, LO out, 10 MHz, 10 MHz out
Power.....	6 W, nominal, with one LO turned on

# AUX I/O (Port 0 DIO <0..3>, Port 1 DIO <0..3>, and PFI <0..3>)

## General Characteristics

Number of channels.....	12 bidirectional (8 DIO and 4 PFI)
Connector type.....	HDMI
Interface standard.....	3.3 LVCMOS

## Interface logic

Maximum $V_{IL}$ .....	0.8 V
Minimum $V_{IH}$ .....	2.0 V
Maximum $V_{OL}$ .....	0.4 V
Minimum $V_{OH}$ .....	2.7 V
Maximum $V_{OH}$ .....	3.6 V

<sup>4</sup> ADCs and DACs are dual-channel components with each channel assigned to I and Q, respectively.

<sup>5</sup> Use the Fractional Interpolation and Decimation DSP blocks implemented in the LabVIEW FPGA target to decimate and interpolate the data.

Z <sub>OUT</sub> .....	50 Ω ± 20%
I <sub>OUT</sub> (DC).....	±2 mA
Pull-down resistor.....	150 kΩ
Recommended operating voltage.....	-0.3 V to 3.6 V
Overvoltage protection.....	±10 V
Maximum toggle frequency.....	6.6 MHz
+5 V maximum power.....	10 mA
+5 V voltage tolerance.....	4.2 V to 5 V

## Compliance and Certifications

### Safety

This product is designed to meet the requirements of the following electrical equipment safety standards for measurement, control, and laboratory use:

- IEC 61010-1, EN 61010-1
- UL 61010-1, CSA 61010-1



**Note** For UL and other safety certifications, refer to the product label or the [Online Product Certification](#) section.

### Electromagnetic Compatibility

This product meets the requirements of the following EMC standards for electrical equipment for measurement, control, and laboratory use:

- EN 61326-1 (IEC 61326-1): Class A emissions; Basic immunity
- EN 55011 (CISPR 11): Group 1, Class A emissions
- AS/NZS CISPR 11: Group 1, Class A emissions
- FCC 47 CFR Part 15B: Class A emissions
- ICES-001: Class A emissions



**Note** In the United States (per FCC 47 CFR), Class A equipment is intended for use in commercial, light-industrial, and heavy-industrial locations. In Europe, Canada, Australia, and New Zealand (per CISPR 11), Class A equipment is intended for use only in heavy-industrial locations.



**Note** Group 1 equipment (per CISPR 11) is any industrial, scientific, or medical equipment that does not intentionally generate radio frequency energy for the treatment of material or inspection/analysis purposes.



**Note** For EMC declarations, certifications, and additional information, refer to the [Online Product Certification](#) section.

# CE Compliance

This product meets the essential requirements of applicable European Directives, as follows:

- 2006/95/EC; Low-Voltage Directive (safety)
- 2004/108/EC; Electromagnetic Compatibility Directive (EMC)

## Online Product Certification

To obtain product certifications and the DoC for this product, visit [ni.com/certification](https://ni.com/certification), search by model number or product line, and click the appropriate link in the Certification column.

## Environmental Management

NI is committed to designing and manufacturing products in an environmentally responsible manner. NI recognizes that eliminating certain hazardous substances from our products is beneficial not only to the environment but also to NI customers.

For additional environmental information, refer to the *Minimize Our Environmental Impact* web page at [ni.com/environment](https://ni.com/environment). This page contains the environmental regulations and directives with which NI complies, as well as other environmental information not included in this document.

## Waste Electrical and Electronic Equipment (WEEE)



**EU Customers** At the end of the product life cycle, all products must be sent to a WEEE recycling center. For more information about WEEE recycling centers, National Instruments WEEE initiatives, and compliance with WEEE Directive 2002/96/EC on Waste Electrical and Electronic Equipment, visit [ni.com/environment/weee.htm](https://ni.com/environment/weee.htm).

## 电子信息产品污染控制管理办法（中国 RoHS）



**中国客户** National Instruments 符合中国电子信息产品中限制使用某些有害物质指令 (RoHS)。关于 National Instruments 中国 RoHS 合规性信息，请登录 [ni.com/environment/rohs\\_china](https://ni.com/environment/rohs_china)。(For information about China RoHS compliance, go to [ni.com/environment/rohs\\_china](https://ni.com/environment/rohs_china).)

## Environment

Maximum altitude.....2,000 m (at 25 °C ambient temperature)

Pollution Degree.....2

Indoor use only.

## Operating Environment

Ambient temperature range.....	0 °C to 55 °C (Tested in accordance with IEC-60068-2-1 and IEC-60068-2-2.)
Relative humidity range.....	10% to 90%, noncondensing (Tested in accordance with IEC-60068-2-56.)

## Storage Environment

Ambient temperature range.....	-40 °C to 70 °C (Tested in accordance with IEC-60068-2-1 and IEC-60068-2-2.)
Relative humidity range.....	5% to 95%, noncondensing (Tested in accordance with IEC-60068-2-56.)
Operational shock.....	30 g peak, half-sine, 11 ms pulse (Tested in accordance with IEC-60068-2-27. Test profile developed in accordance with MIL-PRF-28800F.)
Random vibration	
Operating.....	5 Hz to 500 Hz, 0.3 g <sub>rms</sub>
Nonoperating.....	5 Hz to 500 Hz, 2.4 g <sub>rms</sub> (Tested in accordance with IEC-60068-2-64. Nonoperating test profile exceeds the requirements of MIL-PRF-28800F, Class 3.)

## Installing PXI EMC Filler Panels

To ensure specified EMC performance, PXI EMC filler panels must be properly installed in your NI FlexRIO system. The PXI EMC filler panels (National Instruments part number 778700-01) must be purchased separately. For more installation information, refer to the *NI FlexRIO FPGA Module Installation Guide and Specifications*.

1. Remove the captive screw covers.
2. Install the PXI EMC filler panels by securing the captive mounting screws to the chassis, as shown in the figure below. Make sure that the EMC gasket is on the right side of the PXI EMC filler panel.

**Figure 13.** PXI EMC Filler Panels and Chassis

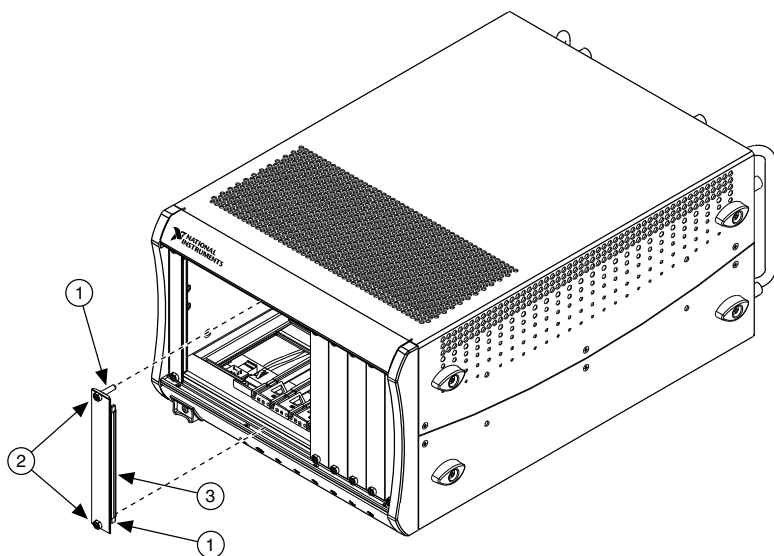

1. Captive Screw Covers
2. Captive Mounting Screws
3. EMC Gasket



**Note** You must populate all slots with a module or a PXI EMC filler panel to ensure proper module cooling. Do not over tighten screws (2.5 lb · in maximum). For additional information about the use of PXI EMC filler panels in your PXI system, visit [ni.com/info](http://ni.com/info) and enter `emcpanels`.

## Related Information

[Electromagnetic Compatibility Guidelines](#) on page 3

## Where to Go for Support

The National Instruments Web site is your complete resource for technical support. At [ni.com/support](http://ni.com/support) you have access to everything from troubleshooting and application development self-help resources to email and phone assistance from NI Application Engineers.

A Declaration of Conformity (DoC) is our claim of compliance with the Council of the European Communities using the manufacturer's declaration of conformity. This system affords the user protection for electromagnetic compatibility (EMC) and product safety. You can obtain the DoC for your product by visiting [ni.com/certification](http://ni.com/certification). If your product supports calibration, you can obtain the calibration certificate for your product at [ni.com/calibration](http://ni.com/calibration).

National Instruments corporate headquarters is located at 11500 North Mopac Expressway, Austin, Texas, 78759-3504. National Instruments also has offices located around the world to

help address your support needs. For telephone support in the United States, create your service request at [ni.com/support](http://ni.com/support) and follow the calling instructions or dial 512 795 8248. For telephone support outside the United States, visit the Worldwide Offices section of [ni.com/niglobal](http://ni.com/niglobal) to access the branch office Web sites, which provide up-to-date contact information, support phone numbers, email addresses, and current events.

Refer to the *NI Trademarks and Logo Guidelines* at [ni.com/trademarks](http://ni.com/trademarks) for information on National Instruments trademarks. Other product and company names mentioned herein are trademarks or trade names of their respective companies. For patents covering National Instruments products/technology, refer to the appropriate location: **Help»Patents** in your software, the `patents.txt` file on your media, or the *National Instruments Patent Notice* at [ni.com/patents](http://ni.com/patents). You can find information about end-user license agreements (EULAs) and third-party legal notices in the readme file for your NI product. Refer to the *Export Compliance Information* at [ni.com/legal/export-compliance](http://ni.com/legal/export-compliance) for the National Instruments global trade compliance policy and how to obtain relevant HTS codes, ECCNs, and other import/export data.

© 2012—2013 National Instruments. All rights reserved.

373845D-01 May13