

# CAN

## NI-CAN™ Hardware and Software Manual

## **Worldwide Technical Support and Product Information**

[ni.com](http://ni.com)

## **Worldwide Offices**

Visit [ni.com/niglobal](http://ni.com/niglobal) to access the branch office Web sites, which provide up-to-date contact information, support phone numbers, email addresses, and current events.

## **National Instruments Corporate Headquarters**

11500 North Mopac Expressway Austin, Texas 78759-3504 USA Tel: 512 683 0100

For further support information, refer to the *NI Services* appendix. To comment on National Instruments documentation, refer to the National Instruments Web site at [ni.com/info](http://ni.com/info) and enter the Info Code feedback.

© 1996–2017 National Instruments. All rights reserved.

# Legal Information

---

## Limited Warranty

This document is provided 'as is' and is subject to being changed, without notice, in future editions. For the latest version, refer to [ni.com/manuals](http://ni.com/manuals). NI reviews this document carefully for technical accuracy; however, NI MAKES NO EXPRESS OR IMPLIED WARRANTIES AS TO THE ACCURACY OF THE INFORMATION CONTAINED HEREIN AND SHALL NOT BE LIABLE FOR ANY ERRORS.

NI warrants that its hardware products will be free of defects in materials and workmanship that cause the product to fail to substantially conform to the applicable NI published specifications for one (1) year from the date of invoice.

For a period of ninety (90) days from the date of invoice, NI warrants that (i) its software products will perform substantially in accordance with the applicable documentation provided with the software and (ii) the software media will be free from defects in materials and workmanship.

If NI receives notice of a defect or non-conformance during the applicable warranty period, NI will, in its discretion: (i) repair or replace the affected product, or (ii) refund the fees paid for the affected product. Repaired or replaced Hardware will be warranted for the remainder of the original warranty period or ninety (90) days, whichever is longer. If NI elects to repair or replace the product, NI may use new or refurbished parts or products that are equivalent to new in performance and reliability and are at least functionally equivalent to the original part or product.

You must obtain an RMA number from NI before returning any product to NI. NI reserves the right to charge a fee for examining and testing Hardware not covered by the Limited Warranty.

This Limited Warranty does not apply if the defect of the product resulted from improper or inadequate maintenance, installation, repair, or calibration (performed by a party other than NI); unauthorized modification; improper environment; use of an improper hardware or software key; improper use or operation outside of the specification for the product; improper voltages; accident, abuse, or neglect; or a hazard such as lightning, flood, or other act of nature.

THE REMEDIES SET FORTH ABOVE ARE EXCLUSIVE AND THE CUSTOMER'S SOLE REMEDIES, AND SHALL APPLY EVEN IF SUCH REMEDIES FAIL OF THEIR ESSENTIAL PURPOSE.

EXCEPT AS EXPRESSLY SET FORTH HEREIN, PRODUCTS ARE PROVIDED "AS IS" WITHOUT WARRANTY OF ANY KIND AND NI DISCLAIMS ALL WARRANTIES, EXPRESSED OR IMPLIED, WITH RESPECT TO THE PRODUCTS, INCLUDING ANY IMPLIED WARRANTIES OF MERCHANTABILITY, FITNESS FOR A PARTICULAR PURPOSE, TITLE OR NON-INFRINGEMENT, AND ANY WARRANTIES THAT MAY ARISE FROM USAGE OF TRADE OR COURSE OF DEALING. NI DOES NOT WARRANT, GUARANTEE, OR MAKE ANY REPRESENTATIONS REGARDING THE USE OF OR THE RESULTS OF THE USE OF THE PRODUCTS IN TERMS OF CORRECTNESS, ACCURACY, RELIABILITY, OR OTHERWISE. NI DOES NOT WARRANT THAT THE OPERATION OF THE PRODUCTS WILL BE UNINTERRUPTED OR ERROR FREE.

In the event that you and NI have a separate signed written agreement with warranty terms covering the products, then the warranty terms in the separate agreement shall control.

## Copyright

Under the copyright laws, this publication may not be reproduced or transmitted in any form, electronic or mechanical, including photocopying, recording, storing in an information retrieval system, or translating, in whole or in part, without the prior written consent of National Instruments Corporation.

National Instruments respects the intellectual property of others, and we ask our users to do the same. NI software is protected by copyright and other intellectual property laws. Where NI software may be used to reproduce software or other materials belonging to others, you may use NI software only to reproduce materials that you may reproduce in accordance with the terms of any applicable license or other legal restriction.

## End-User License Agreements and Third-Party Legal Notices

You can find end-user license agreements (EULAs) and third-party legal notices in the following locations:

- Notices are located in the <National Instruments>\\_Legal Information and <National Instruments> directories.
- EULAs are located in the <National Instruments>\Shared\MDF\Legal\license directory.
- Review <National Instruments>\\_Legal Information.txt for information on including legal information in installers built with NI products.

## U.S. Government Restricted Rights

If you are an agency, department, or other entity of the United States Government ("Government"), the use, duplication, reproduction, release, modification, disclosure or transfer of the technical data included in this manual is governed by the Restricted Rights provisions under Federal Acquisition Regulation 52.227-14 for civilian agencies and Defense Federal Acquisition Regulation Supplement Section 252.227-7014 and 252.227-7015 for military agencies.

## Trademarks

Refer to the *NI Trademarks and Logo Guidelines* at [ni.com/trademarks](http://ni.com/trademarks) for more information on National Instruments trademarks.

ARM, Keil, and  $\mu$ Vision are trademarks or registered of ARM Ltd or its subsidiaries.

LEGO, the LEGO logo, WEDO, and MINDSTORMS are trademarks of the LEGO Group.

TETRIX by Pitsco is a trademark of Pitsco, Inc.

FIELDBUS FOUNDATION™ and FOUNDATION™ are trademarks of the Fieldbus Foundation.

EtherCAT® is a registered trademark of and licensed by Beckhoff Automation GmbH.

CANopen® is a registered Community Trademark of CAN in Automation e.V.

DeviceNet™ and EtherNet/IP™ are trademarks of ODVA.

Go!, SensorDAQ, and Vernier are registered trademarks of Vernier Software & Technology. Vernier Software & Technology and [vernier.com](http://vernier.com) are trademarks or trade dress.

Xilinx is the registered trademark of Xilinx, Inc.

Taptite and Trilobular are registered trademarks of Research Engineering & Manufacturing Inc.

FireWire® is the registered trademark of Apple Inc.

Linux® is the registered trademark of Linus Torvalds in the U.S. and other countries.

Handle Graphics®, MATLAB®, Real-Time Workshop®, Simulink®, Stateflow®, and xPC TargetBox® are registered trademarks, and TargetBox™ and Target Language Compiler™ are trademarks of The MathWorks, Inc.

Tektronix®, Tek, and Tektronix, Enabling Technology are registered trademarks of Tektronix, Inc.

The Bluetooth® word mark is a registered trademark owned by the Bluetooth SIG, Inc.

The ExpressCard™ word mark and logos are owned by PCMCIA and any use of such marks by National Instruments is under license.

The mark LabWindows is used under a license from Microsoft Corporation. Windows is a registered trademark of Microsoft Corporation in the United States and other countries.

Other product and company names mentioned herein are trademarks or trade names of their respective companies.

Members of the National Instruments Alliance Partner Program are business entities independent from National Instruments and have no agency, partnership, or joint-venture relationship with National Instruments.

### **Patents**

For patents covering National Instruments products/technology, refer to the appropriate location: **Help»Patents** in your software, the `patents.txt` file on your media, or the *National Instruments Patent Notice* at [ni.com/patents](http://ni.com/patents).

### **Export Compliance Information**

Refer to the *Export Compliance Information* at [ni.com/legal/export-compliance](http://ni.com/legal/export-compliance) for the National Instruments global trade compliance policy and how to obtain relevant HTS codes, ECCNs, and other import/export data.

### **WARNING REGARDING USE OF NATIONAL INSTRUMENTS PRODUCTS**

YOU ARE ULTIMATELY RESPONSIBLE FOR VERIFYING AND VALIDATING THE SUITABILITY AND RELIABILITY OF THE PRODUCTS WHENEVER THE PRODUCTS ARE INCORPORATED IN YOUR SYSTEM OR APPLICATION, INCLUDING THE APPROPRIATE DESIGN, PROCESS, AND SAFETY LEVEL OF SUCH SYSTEM OR APPLICATION.

PRODUCTS ARE NOT DESIGNED, MANUFACTURED, OR TESTED FOR USE IN LIFE OR SAFETY CRITICAL SYSTEMS, HAZARDOUS ENVIRONMENTS OR ANY OTHER ENVIRONMENTS REQUIRING FAIL-SAFE PERFORMANCE, INCLUDING IN THE OPERATION OF NUCLEAR FACILITIES; AIRCRAFT NAVIGATION; AIR TRAFFIC CONTROL SYSTEMS; LIFE SAVING OR LIFE SUSTAINING SYSTEMS OR SUCH OTHER MEDICAL DEVICES; OR ANY OTHER APPLICATION IN WHICH THE FAILURE OF THE PRODUCT OR SERVICE COULD LEAD TO DEATH, PERSONAL INJURY, SEVERE PROPERTY DAMAGE OR ENVIRONMENTAL HARM (COLLECTIVELY, "HIGH-RISK USES"). FURTHER, PRUDENT STEPS MUST BE TAKEN TO PROTECT AGAINST FAILURES, INCLUDING PROVIDING BACK-UP AND SHUT-DOWN MECHANISMS. NI EXPRESSLY DISCLAIMS ANY EXPRESS OR IMPLIED WARRANTY OF FITNESS OF THE PRODUCTS OR SERVICES FOR HIGH-RISK USES.

# Compliance

---

## Electromagnetic Compatibility Information

This hardware has been tested and found to comply with the applicable regulatory requirements and limits for electromagnetic compatibility (EMC) as indicated in the hardware's Declaration of Conformity (DoC)<sup>1</sup>. These requirements and limits are designed to provide reasonable protection against harmful interference when the hardware is operated in the intended electromagnetic environment. In special cases, for example when either highly sensitive or noisy hardware is being used in close proximity, additional mitigation measures may have to be employed to minimize the potential for electromagnetic interference.

While this hardware is compliant with the applicable regulatory EMC requirements, there is no guarantee that interference will not occur in a particular installation. To minimize the potential for the hardware to cause interference to radio and television reception or to experience unacceptable performance degradation, install and use this hardware in strict accordance with the instructions in the hardware documentation and the DoC<sup>1</sup>.

If this hardware does cause interference with licensed radio communications services or other nearby electronics, which can be determined by turning the hardware off and on, you are encouraged to try to correct the interference by one or more of the following measures:

- Reorient the antenna of the receiver (the device suffering interference).
- Relocate the transmitter (the device generating interference) with respect to the receiver.
- Plug the transmitter into a different outlet so that the transmitter and the receiver are on different branch circuits.

Some hardware may require the use of a metal, shielded enclosure (windowless version) to meet the EMC requirements for special EMC environments such as, for marine use or in heavy industrial areas. Refer to the hardware's user documentation and the DoC<sup>1</sup> for product installation requirements.

When the hardware is connected to a test object or to test leads, the system may become more sensitive to disturbances or may cause interference in the local electromagnetic environment.

Operation of this hardware in a residential area is likely to cause harmful interference. Users are required to correct the interference at their own expense or cease operation of the hardware.

Changes or modifications not expressly approved by National Instruments could void the user's right to operate the hardware under the local regulatory rules.

---

<sup>1</sup> The Declaration of Conformity (DoC) contains important EMC compliance information and instructions for the user or installer. To obtain the DoC for this product, visit [ni.com/certification](http://ni.com/certification), search by model number or product line, and click the appropriate link in the Certification column.

# Contents

---

## About This Manual

PCI-CAN .....	xvii
PXI-846x .....	xvii
PCMCIA-CAN .....	xvii
USB-CAN .....	xviii
USB-LIN .....	xviii
Related Documentation .....	xix

## Chapter 1

### Introduction

CAN Overview .....	1-1
Simplified CAN Data Frame .....	1-1
LIN Overview .....	1-2
NI CAN Hardware Overview .....	1-2
About the NI CAN Series 2 Hardware .....	1-2
Series 2 Vs. Series 1 .....	1-4
PCI and PXI .....	1-6
PCMCIA .....	1-7
PCMCIA Cables .....	1-7
About the USB-847x Hardware .....	1-8
CAN: USB-8472, USB-8472s, USB-8473, USB-8473s .....	1-8
LIN: USB-8476, USB-8476s .....	1-9
NI-CAN Software Overview .....	1-9
MAX .....	1-9
Frame API .....	1-10
Channel API .....	1-10

## Chapter 2

### Installation and Configuration

Safety Information .....	2-1
Measurement & Automation Explorer (MAX) .....	2-3
Verify Installation of CAN and LIN Hardware .....	2-3
Configure CAN and LIN Ports .....	2-4
CAN Channels .....	2-4
LabVIEW Real-Time (RT) Configuration .....	2-5
PXI System .....	2-6
CompactRIO System .....	2-6

Tools .....	2-7
Using NI-CAN with NI-DNET .....	2-7

## Chapter 3

### NI CAN and LIN Hardware

Philips SJA1000 CAN Controller .....	3-1
PCI-CAN .....	3-2
High-Speed Physical Layer.....	3-2
Transceiver .....	3-2
Bus Power Requirements.....	3-2
VBAT Jumper.....	3-2
Low-Speed/Fault-Tolerant Physical Layer .....	3-4
Transceiver .....	3-4
Bus Power Requirements.....	3-5
VBAT Jumper.....	3-5
Low-Speed/Fault-Tolerant VBAT Jumper Settings .....	3-6
Single Wire Physical Layer.....	3-7
Transceiver .....	3-7
Bus Power Requirements.....	3-7
VBAT Jumper.....	3-8
XS Software Selectable Physical Layer.....	3-8
RTSI.....	3-9
PXI-846x.....	3-11
High-Speed Physical Layer.....	3-11
Transceiver .....	3-11
Bus Power Requirements.....	3-11
VBAT Jumper.....	3-11
Low-Speed/Fault-Tolerant Physical Layer .....	3-13
Transceiver .....	3-13
Bus Power Requirements.....	3-13
VBAT Jumper.....	3-14
Single Wire Physical Layer.....	3-15
Transceiver .....	3-15
Bus Power Requirements.....	3-16
VBAT Jumper.....	3-16
XS Software Selectable Physical Layer.....	3-16
PXI Trigger Bus (RTSI).....	3-18
PCMCIA-CAN .....	3-20
PCMCIA-CAN High-Speed Cables.....	3-20
Transceiver .....	3-20
Bus Power Requirements.....	3-20

PCMCIA-CAN Low-Speed/Fault-Tolerant Cables .....	3-21
Transceiver .....	3-21
Bus Power Requirements .....	3-21
PCMCIA-CAN Single Wire Cables .....	3-22
Transceiver .....	3-22
Bus Power Requirements .....	3-22
Synchronization .....	3-23
USB-CAN .....	3-25
USB-8473/USB-8473s: High-Speed Physical Layer .....	3-25
Transceiver .....	3-26
Bus Power Requirements .....	3-26
LED Indicators .....	3-26
USB-8472/USB-8472s: Low-Speed/Fault-Tolerant Physical Layer.....	3-27
Transceiver .....	3-27
Bus Power Requirements .....	3-27
LED Indicators .....	3-28
USB-LIN.....	3-28
USB-8476/USB-8476s: LIN .....	3-28
Transceiver .....	3-28
Bus Power Requirements .....	3-28
LED Indicators .....	3-29
Synchronization in USB-CAN/LIN Devices .....	3-29
CAN for CompactRIO .....	3-32
What is CompactRIO?.....	3-32
NI 985x .....	3-32

## Chapter 4

### Connectors and Cables

High-Speed CAN Pinout Cable .....	4-1
High-Speed PCI, PXI, and USB Connector Pinout.....	4-1
PCMCIA Connector Pinout .....	4-2
Cabling Requirements for High-Speed CAN.....	4-4
Cable Lengths .....	4-4
Number of Devices .....	4-5
Cable Termination.....	4-5
Cabling Example.....	4-6
Low-Speed/Fault-Tolerant CAN Pinout Cable.....	4-6
Low-Speed/Fault-Tolerant PCI, PXI, and USB Connector Pinout .....	4-6
PCMCIA Connector Pinout .....	4-8
Cabling Requirements for Low-Speed/Fault-Tolerant CAN .....	4-9
Number of Devices .....	4-10
Termination .....	4-10



Determining the Necessary Termination Resistance for the Board.....	4-10
Software Selectable Termination (USB-8472s only) .....	4-13
Replacing the Termination Resistors on Your PCI-CAN/LS Board.....	4-13
Replacing the Termination Resistors on the PXI-8460 Board .....	4-15
Replacing the Termination Resistors on the PCMCIA-CAN/LS Cable .....	4-16
Cabling Example .....	4-17
Single Wire CAN Pinout Cable.....	4-17
Single Wire PCI and PXI Connector Pinout.....	4-17
PCMCIA-CAN Connector Pinout .....	4-19
Cabling Requirements for Single Wire CAN .....	4-20
Cable Length.....	4-20
Number of Devices .....	4-20
Termination (Bus Loading) .....	4-20
Cabling Example .....	4-21
XS CAN Pinout Cable.....	4-21
XS PCI and PXI Connector Pinout .....	4-21
Cabling Requirements for XS CAN.....	4-23
External Transceiver Example.....	4-24
LIN .....	4-24
USB-LIN Connector Pinout.....	4-24
Cabling Requirements for LIN Specifications (LIN) .....	4-26
Cable Specifications .....	4-26
Cable Lengths .....	4-26
Number of Devices .....	4-26
Termination .....	4-26

## Chapter 5

### Application Development

Choose the Programming Language .....	5-1
LabVIEW .....	5-1
LabWindows/CVI .....	5-2
Visual C++ 6 .....	5-2
Borland C/C++ .....	5-3
Microsoft Visual Basic.....	5-4
Other Programming Languages .....	5-4
Choose Which API To Use .....	5-6

## Chapter 6

### Using the Channel API

Choose Source of Channel Configuration .....	6-1
Already Have a CAN Database File? .....	6-2
Application Uses a Subset of Channels? .....	6-2
Import CAN Database into MAX .....	6-2
Access CAN Database within Application .....	6-3
User Must Create within Application? .....	6-3
Use Create Message Function in Application .....	6-3
Create in MAX .....	6-4
Channel API Basic Programming Model .....	6-4
Init Start .....	6-5
Read .....	6-6
sample rate = 0 .....	6-6
sample rate > 0 .....	6-7
Read Timestamped .....	6-8
Write .....	6-8
sample rate = 0 .....	6-9
sample rate > 0, Output mode .....	6-9
sample rate > 0, Output Recent mode .....	6-10
Clear .....	6-10
Channel API Additional Programming Topics .....	6-11
Get Names .....	6-11
Synchronization .....	6-11
Set Property .....	6-12
Frame to Channel Conversion .....	6-12
When Should I Use Frame to Channel Conversion? .....	6-13
Logging .....	6-13
CompactRIO .....	6-14
Development without CAN Hardware .....	6-15
Database Queries .....	6-15
Enhance an Existing Frame API Application .....	6-15
USB-847x .....	6-15
Virtual Bus Timing .....	6-16
Limitations .....	6-17
Programming Model for Virtual Bus Timing Disabled .....	6-21
Mode Dependent Channels .....	6-23
Mode Dependent Channels in MAX .....	6-24

## Chapter 7

### Channel API for LabVIEW

Section Headings .....	7-1
List of VIs.....	7-1
CAN Clear.vi.....	7-4
CAN Clear with NI-DAQ.vi.....	7-6
CAN Clear with NI-DAQmx.vi .....	7-8
CAN Clear Multiple with NI-DAQ.vi.....	7-10
CAN Clear Multiple with NI-DAQmx.vi.....	7-12
CAN Connect Terminals.vi .....	7-14
CAN Create Message.vi .....	7-24
CAN Create MessageEx.vi.....	7-30
CAN Disconnect Terminals.vi .....	7-37
CAN Get Names.vi.....	7-39
CAN Get Property.vi .....	7-42
CAN Initialize.vi .....	7-55
CAN Init Start.vi .....	7-59
CAN Read.vi .....	7-65
CAN Set Property.vi.....	7-73
CAN Start.vi .....	7-88
CAN Stop.vi .....	7-90
CAN Sync Start with NI-DAQ.vi.....	7-92
CAN Sync Start with NI-DAQmx.vi.....	7-94
CAN Sync Start Multiple with NI-DAQ.vi.....	7-97
CAN Sync Start Multiple with NI-DAQmx.vi.....	7-100
CAN Write.vi .....	7-103

## Chapter 8

### Channel API for C

Section Headings .....	8-1
Data Types.....	8-1
List of Functions.....	8-2
nctClear.....	8-4
nctConnectTerminals.....	8-5
nctCreateMessage.....	8-15
nctCreateMessageEx .....	8-20
nctDisconnectTerminals .....	8-26
nctGetNames .....	8-28
nctGetNamesLength .....	8-31
nctGetProperty.....	8-33
nctInitialize .....	8-44
nctInitStart .....	8-47

nctRead .....	8-53
nctReadTimestamped.....	8-57
nctSetProperty.....	8-60
nctStart .....	8-75
nctStop .....	8-76
nctWrite .....	8-77

## Chapter 9

### Using the Frame API

Choose Which Objects To Use.....	9-1
Using CAN Network Interface Objects.....	9-1
Using LIN Network Interface Objects .....	9-2
Using CAN Objects.....	9-3
Frame API Basic Programming Model for CAN .....	9-4
Frame API Basic Programming Model for LIN .....	9-7
LIN Interface as Bus Monitor.....	9-7
LIN Interface as Master.....	9-10
LIN Interface as Slave Device.....	9-14
LIN Interface Accesses Single Subscribing Slave Device .....	9-17
LIN Interface Accesses Single Publishing Slave Device .....	9-20
LIN Interface Sleep and Wakeup Behavior.....	9-23
Frame API Additional Programming Topics.....	9-25
RTSI .....	9-25
Remote Frames.....	9-25
Using Queues.....	9-26
State Transitions .....	9-26
Empty Queues .....	9-26
Full Queues.....	9-27
Disabling Queues.....	9-27
Using the CAN Network Interface Object with CAN Objects.....	9-27
Detecting State Changes.....	9-29
Frame to Channel Conversion.....	9-29
Differences between CAN and LIN .....	9-30

## Chapter 10

### Frame API for LabVIEW

Section Headings .....	10-1
List of VIs .....	10-2
ncAction.vi.....	10-4
ncClose.vi .....	10-8
ncConfigCANNet.vi .....	10-10
ncConfigCANNetRTSI.vi.....	10-15

ncConfigCANObj.vi.....	10-19
ncConfigCANObjRTSL.vi.....	10-27
ncConnectTerminals.vi.....	10-32
ncDisconnectTerminals.vi.....	10-41
ncGetAttr.vi.....	10-43
ncGetHardwareInfo.vi.....	10-58
ncGetTimer.vi.....	10-63
ncOpen.vi.....	10-65
ncReadNet.vi.....	10-68
ncReadNetMult.vi.....	10-79
ncReadObj.vi.....	10-90
ncReadObjMult.vi.....	10-93
ncSetAttr.vi.....	10-96
ncWaitForState.vi.....	10-125
ncWriteNet.vi.....	10-129
ncWriteNetMult.vi.....	10-137
ncWriteObj.vi.....	10-149

## Chapter 11

### Frame API for C

Section Headings.....	11-1
Data Types.....	11-2
List of Functions.....	11-3
ncAction.....	11-5
ncCloseObject.....	11-8
ncConfig.....	11-9
ncConnectTerminals.....	11-30
ncCreateNotification.....	11-40
ncDisconnectTerminals.....	11-45
ncGetAttribute.....	11-47
ncGetHardwareInfo.....	11-62
ncOpenObject.....	11-67
ncRead.....	11-69
ncReadMult.....	11-82
ncSetAttribute.....	11-84
ncStatusToString.....	11-113
ncWaitForState.....	11-116
ncWrite.....	11-119
ncWriteMult.....	11-127

## Appendix A

### Troubleshooting and Common Questions

Troubleshooting with the Measurement & Automation Explorer (MAX) .....	A-1
Troubleshooting Self Test Failures .....	A-2
Common Questions.....	A-3

## Appendix B

### Summary of the CAN Standard

History and Use of CAN.....	B-1
CAN Identifiers and Message Priority.....	B-2
CAN Frames .....	B-3
CAN Error Detection and Confinement .....	B-5
Low-Speed CAN.....	B-8

## Appendix C

### Summary of the LIN Standard

History and Use of LIN .....	C-1
LIN Frame Format .....	C-1
LIN Bus Timing.....	C-4
LIN Topology and Behavior.....	C-5
LIN Error Detection and Confinement .....	C-6
LIN Sleep and Wakeup.....	C-6
Advanced Frame Types .....	C-7
Additional LIN Information.....	C-8

## Appendix D

### Frame Types for CAN and LIN Hardware

## Appendix E

### Specifications

PCI-CAN Series 2.....	E-1
PXI-846x Series 2 .....	E-4
PCMCIA-CAN Series 2.....	E-7
USB-CAN and USB-LIN .....	E-10

## **Appendix F**

### **NI-XNET Compatibility for NI-CAN**

Overview and Purpose.....	F-1
Installation and Configuration.....	F-1
Limitations.....	F-3
Broken Compatibility .....	F-3

## **Appendix G**

### **NI Services**

## **Glossary**

## **Index**

# About This Manual

---

Use the *NI-CAN Software and Hardware Installation Guide* included with your kit to install and configure the NI-CAN hardware and software. Use this manual to learn the basics of NI-CAN, as well as how to develop an application.

This manual contains specific programmer reference information about each NI-CAN function and VI.

This manual also describes the hardware features. Unless otherwise noted, this manual applies to the NI CAN Series 2 products, which include the following.

## PCI-CAN

---

- PCI-CAN Series 2 (High-Speed; 1 port)
- PCI-CAN/2 Series 2 (High-Speed; 2 ports)
- PCI-CAN/LS Series 2 (Low-Speed/Fault-Tolerant; 1 port)
- PCI-CAN/LS2 Series 2 (Low-Speed/Fault-Tolerant; 2 ports)
- PCI-CAN/XS Series 2 (Software Selectable; 1 port)
- PCI-CAN/XS2 Series 2 (Software Selectable; 2 ports)

## PXI-846x

---

- PXI-8461 Series 2 (High-Speed; 1 or 2 ports)
- PXI-8460 Series 2 (Low-Speed/Fault-Tolerant; 1 or 2 ports)
- PXI-8464 Series 2 (Software Selectable; 1 or 2 ports)

## PCMCIA-CAN

---

- PCMCIA-CAN Series 2 (High-Speed; 1 port)
- PCMCIA-CAN/2 Series 2 (High-Speed; 2 ports)
- PCMCIA-CAN/LS Series 2 (Low-Speed/Fault-Tolerant; 1 port)
- PCMCIA-CAN/LS2 Series 2 (Low-Speed/Fault-Tolerant; 2 port)
- PCMCIA-CAN/SW Series 2 (Single Wire; 1 port)



- PCMCIA-CAN/HS/LS Series 2 (1 port High-Speed, 1 port Low-Speed/Fault-Tolerant)
- PCMCIA-CAN/HS/SW Series 2 (1 port High-Speed, 1 port Single Wire)

## USB-CAN

---

- USB-8473 (High-Speed CAN; 1 port)
- USB-8473s (High-Speed CAN; 1 port, with Synchronization)
- USB-8472 (Low-Speed CAN; 1 port)
- USB-8472s (Low-Speed CAN; 1 port, with Synchronization)

## USB-LIN

---

- USB-8476 (LIN; 1 port)
- USB-8476s (LIN; 1 port, with Synchronization)

NI-CAN hardware products that pre-date the Series 2 product line are now referred to as Series 1. NI CAN Series 2 products contain several enhancements over Series 1 products, including the Philips SJA1000 CAN controller, improved RTSI synchronization features, updated CAN transceivers, and XS Software Selectable hardware for PCI and PXI. NI-CAN software continues to fully support Series 1 hardware. However, some advanced features are available only with Series 2 hardware. For instance, with PCMCIA, both the card and the cable must be Series 2 to use the advanced features. For a complete description of the differences between Series 1 and Series 2 NI CAN hardware, refer to the [Series 2 Vs. Series 1](#) section of Chapter 1, [Introduction](#).

To obtain complete documentation of NI CAN Series 1 hardware, refer to the previous version of the *NI-CAN Hardware and Software Manual*, part number 370289x-01, where *x* is the letter preceding the one used in this manual. The previous version of this manual is available at [ni.com/manuals](http://ni.com/manuals).

## Related Documentation

---

The following documents contain information that you might find helpful as you read this manual:

- ANSI/ISO Standard 11898-1993, *Road Vehicles—Interchange of Digital Information—Controller Area Network (CAN) for High-Speed Communication*
- ANSI/ISO Standard 11519-1, 2 *Road Vehicles—Low Speed Serial Data Communications, Part 1 and 2*
- *CAN Specification Version 2.0*, 1991, Robert Bosch GmbH., Postfach 106050, D-70049 Stuttgart 1
- *CiA Draft Standard 102*, Version 2.0, CAN Physical Layer for Industrial Applications
- *CompactPCI Specification*, Revision 2.0, PCI Industrial Computers Manufacturers Group
- *DeviceNet Specification*, Version 2.0, Open DeviceNet Vendor Association
- *PXI Hardware Specification*, Revision 2.1, National Instruments Corporation
- *PXI Software Specification*, Revision 2.1, National Instruments Corporation
- LabVIEW Online Reference
- Measurement and Automation Explorer (MAX) Online Reference
- Microsoft Win32 Software Development Kit (SDK) Online Help
- SAE J2411, *Single Wire CAN Recommended Practices*

---

# Introduction

This chapter provides an introduction to the Controller Area Network (CAN), the Local Interconnect Network (LIN), and the National Instruments products for CAN and LIN.

## CAN Overview

---

The data frame is the fundamental unit of data transfer on a CAN network. Figure 1-1 shows a simplified view of the CAN data frame.

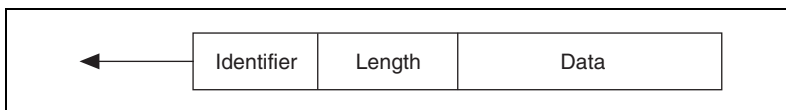

Figure 1-1. CAN Data Frame

### Simplified CAN Data Frame

When multiple CAN devices transmit a frame at the same time, the identifier (ID) resolves the collision. The highest priority ID continues, and the lower priority IDs retry immediately afterward. The ISO 11898 CAN standard specifies two ID formats: the standard format of 11 bits and the extended format of 29 bits.

The ID is followed by a length code that specifies the number of data bytes in the frame. The length ranges from 0 to 8 data bytes. The ID value determines the meaning of the data bytes.

In addition to the data frame, the CAN standard specifies the remote frame. The remote frame includes the ID, but no data bytes. A CAN device transmits the remote frame to request that another device transmit the associated data frame for the ID. In other words, the remote frame provides a mechanism to poll for data.

The preceding information provides a simplified description of CAN frames. The CAN frame format includes many other fields, such as for error checking and acknowledgement. For more detailed information on the ISO 11898 CAN standard, refer to Appendix B, *Summary of the CAN Standard*.

## LIN Overview

---

The LIN bus uses a Master/Slave approach, comprised of a LIN Master and one or more LIN Slaves. Figure 1-2 shows a simplified view of the LIN message frame.

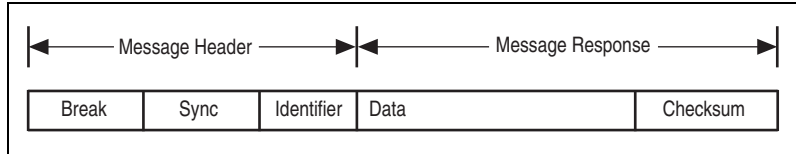

**Figure 1-2.** LIN Message Frame

The message header consists of a break used to identify the start of the frame and the sync field used by the slave node for clock synchronization. The identifier (ID) consists of a 6-bit message ID and a 2-bit parity field. The ID denotes a specific message address, but not the destination. Upon reception and interpretation of the ID one slave will begin the message response. The message response consists of 1–8 bytes of data and an 8-bit checksum.

The sequencing of message frames is controlled by the master and is fixed in a schedule. The schedule may be changed as needed.

The preceding information provides a simplified description of the LIN message frame. For more details on the LIN message frame and on the LIN specification, refer to Appendix C, *Summary of the LIN Standard*.

## NI CAN Hardware Overview

---

This section describes the NI CAN and LIN hardware.

### About the NI CAN Series 2 Hardware

NI CAN Series 2 hardware and the NI-CAN software package provide an easy and powerful way to use a desktop or notebook PC to interface to a CAN bus. The hardware features the Philips SJA1000 CAN controller, which is CAN 2.0B compatible and supports a variety of transfer rates up to 1 Mbps. All NI CAN Series 2 hardware uses the Intel 386EX embedded processor to implement time-critical features provided by the NI-CAN software. NI CAN Series 2 hardware supports High-Speed and

Low-Speed/Fault-Tolerant physical layers, which fully conform to the ISO 11898 physical layer specification for CAN. In addition, NI CAN Series 2 hardware supports Single Wire CAN.

PCI-CAN Series 2 hardware supports the Real-Time System Integration (RTSI) bus as a way to synchronize multiple interface cards in a system by sharing common timing and triggering signals.

PXI-846x Series 2 hardware supports the PXI trigger bus as a way to synchronize multiple interface cards in a system by sharing common timing and triggering signals.

PCMCIA-CAN Series 2 cards provide a way to synchronize multiple devices by using the PCMCIA-CAN Synchronization cable to externally connect to shared timing and triggering signals. For more information about the synchronization capabilities of the NI CAN Series 2 hardware, refer to the [RTSI](#) section, the [PXI Trigger Bus \(RTSI\)](#) section, or the [Synchronization](#) section of Chapter 3, *NI CAN and LIN Hardware*, for the appropriate hardware type.

PCI-CAN Series 2 hardware is software configurable and compliant with the PCI Local Bus Specification. It features the National Instruments MITE bus interface chip that connects the card to the PCI I/O bus. With a PCI-CAN Series 2 card, you can make the PC-compatible computer with PCI Local Bus slots communicate with and control CAN devices.

PXI-846x Series 2 hardware is software configurable and compliant with the *PXI Specification* and the *CompactPCI Specification*. It features the National Instruments MITE bus interface chip that connects the card to the PXI or CompactPCI I/O bus. With a PXI-846x Series 2 card, you can make the PXI or CompactPCI chassis communicate with and control CAN devices.

PCMCIA-CAN Series 2 hardware is a 16-bit, Type II PC Card that is software configurable and compliant with the PCMCIA standards for 16-bit PC Cards. With a PCMCIA-CAN Series 2 card, you can make the PC-compatible notebook with PCMCIA slots communicate with and control CAN devices.

## Series 2 Vs. Series 1

The technical information in this manual applies to the NI CAN Series 2 hardware. You can easily identify the series of the NI CAN hardware by looking at the label. Use Figure 1-3, Figure 1-4, Figure 1-5, and Figure 1-6 to determine if the hardware is Series 1 or Series 2. If the label does not indicate Series 2, the hardware is Series 1. For complete documentation of NI CAN Series 1 hardware, refer to [ni.com/manuals](http://ni.com/manuals) and search for the part number 370289E-01 to access the October 2002 edition of the *NI-CAN Hardware and Software Manual*.

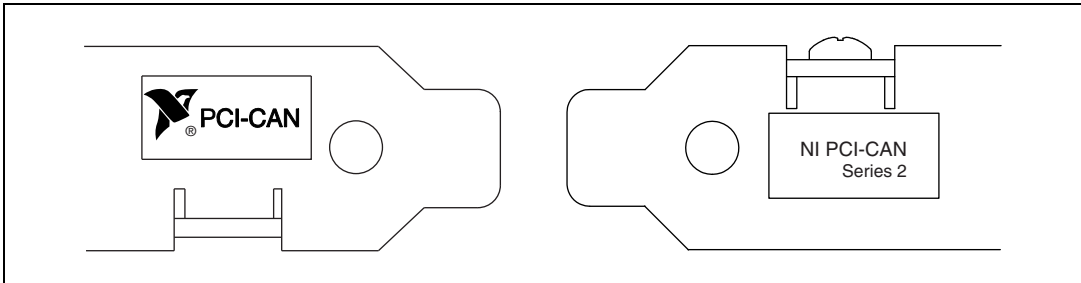

**Figure 1-3.** NI PCI-CAN Hardware Series 1 and 2 Labels

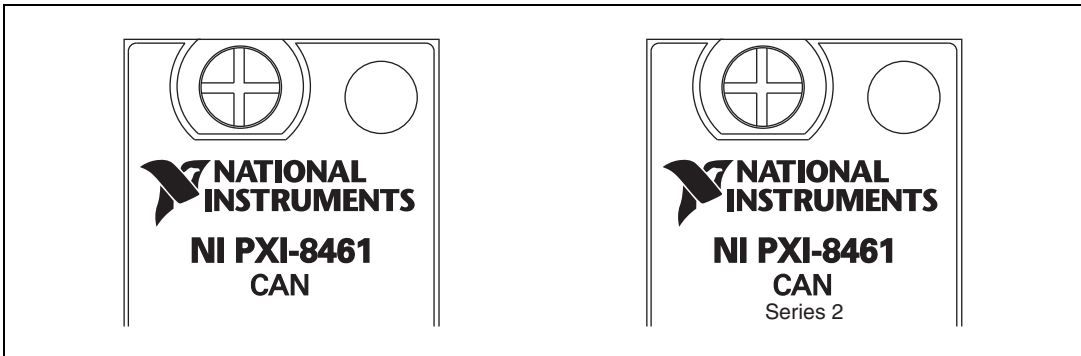

**Figure 1-4.** NI PXI-CAN Hardware Series 1 and 2 Labels

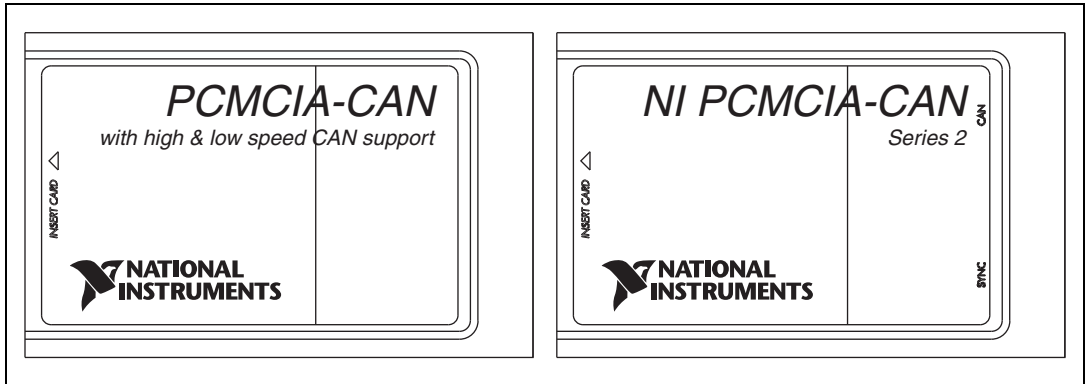

Figure 1-5. NI PCMCIA-CAN Hardware Series 1 and 2 Labels

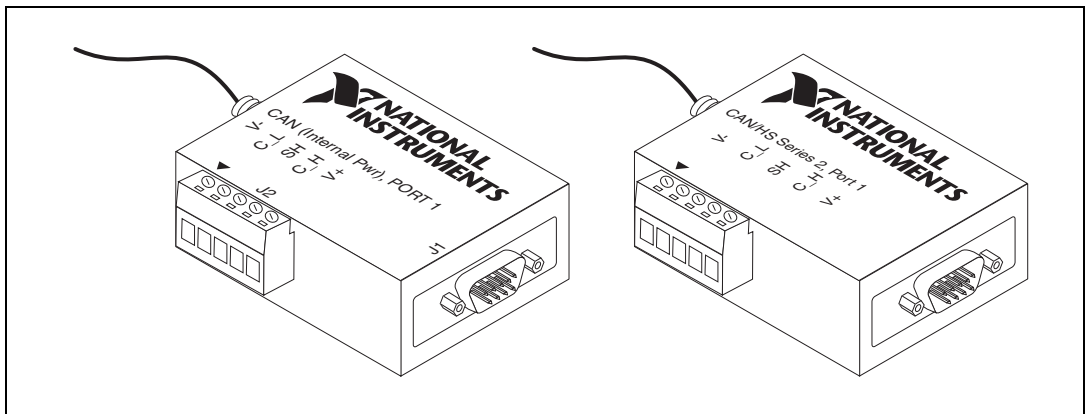
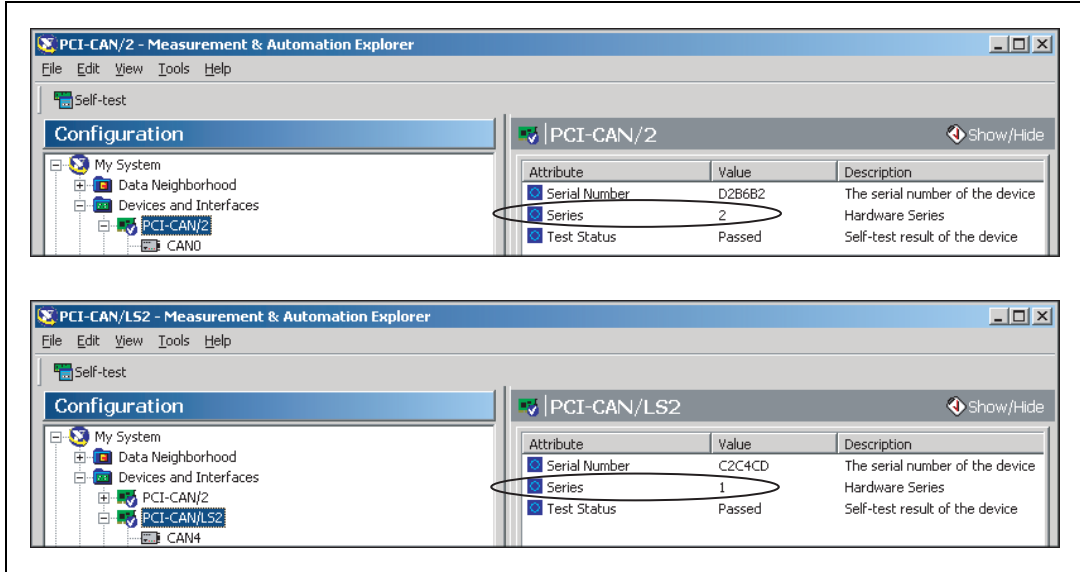

Figure 1-6. NI PCMCIA-CAN Series 1 and 2 Cables

The hardware series is also displayed in MAX, as shown in Figure 1-7.



**Figure 1-7.** Hardware Series Displayed in MAX

The new and improved features supported only by NI CAN Series 2 hardware include:

## PCI and PXI

- Philips SJA1000 CAN controller. Series 1 hardware supported the Intel 82527 CAN controller. For more specific information about the SJA1000 CAN controller, refer to the [Philips SJA1000 CAN Controller](#) section of Chapter 3, *NI CAN and LIN Hardware*.
- Improved RTSI synchronization features. For more information about the synchronization capabilities of the NI CAN Series 2 hardware, refer to the [RTSI](#) section, the [PXI Trigger Bus \(RTSI\)](#) section, or the [Synchronization](#) section of Chapter 3, *NI CAN and LIN Hardware*, for the appropriate hardware type.
- Single Wire CAN support.
- XS Software selectable physical layer hardware. This feature allows you to easily configure a CAN port in software to be a High-Speed, Low-Speed/Fault-Tolerant, Single Wire, or external transceiver interface.



- Upgraded CAN transceivers. High-speed hardware uses the Philips TJA1041 transceiver; Low-Speed/Fault-Tolerant hardware uses the Philips TJA1054A transceiver. Both transceivers have increased voltage tolerance and improved EMC performance over their NI CAN Series 1 predecessors.
- Internally powered physical layer with independent jumper option for controlling the VBAT transceiver input pin either internally or externally. This means High-Speed and Low-Speed/Fault-Tolerant hardware is fully functional by default without supplying any bus power. A jumper option exists to select the source for the VBAT transceiver pin between internal (default) or external. Note that Single Wire CAN requires external bus power.

## PCMCIA

- Philips SJA1000 CAN controller. Series 1 hardware supported the Intel 82527 CAN controller. For more specific information about the SJA1000 CAN controller, refer to the [Philips SJA1000 CAN Controller](#) section of Chapter 3, *NI CAN and LIN Hardware*.
- Synchronization capability for PCMCIA hardware. For more information about PCMCIA synchronization, refer to the [Synchronization](#) section of Chapter 3, *NI CAN and LIN Hardware*.
- Improved performance and reduced power consumption. For more information, refer to Appendix C, [Summary of the LIN Standard](#).

## PCMCIA Cables

- Single Wire CAN support.
- Upgraded CAN transceivers. High-speed hardware uses the Philips TJA1041 transceiver; Low-Speed/Fault-Tolerant hardware uses the Philips TJA1054A transceiver. Both transceivers have increased voltage tolerance and improved EMC performance over their NI CAN Series 1 predecessors.
- Internally powered physical layer for High-Speed and Low-Speed/Fault Tolerant. This means High-Speed and Low-Speed/Fault-Tolerant hardware is fully functional by default without supplying any bus power. Note that Single Wire CAN requires external bus power.

- NI-CAN 2.2 is required for full functionality of the PCMCIA cables. Using these cables with any version of NI-CAN prior to 2.2 will prevent use of the following functions:
  - High-speed error reporting
  - Transceiver sleep modes
  - Single-wire transceivers

## About the USB-847x Hardware

NI USB-847x hardware provides a powerful and flexible way to interface any desktop or notebook PC to a CAN or LIN bus via USB. All CAN hardware features the Philips SJA1000 CAN controller, which is CAN 2.0B compatible and supports a variety of transfer rates up to 1 Mbps. The SJA1000 also includes a number of features well-suited to diagnostic applications. USB-847x hardware supports High-Speed and Low-Speed/Fault-Tolerant physical layers, which fully conform to the ISO 11898 specification for CAN. All LIN devices are LIN 1.3, LIN 2.0 and SAE J2602 compliant and support the full range of LIN baud rates.

NI USB-847x with Sync series hardware is based on a powerful USB 2.0 compatible microcontroller capable of host data transfer rates up to 480 Mbps. The hardware includes onboard buffers to prevent dropped frames at high CAN data rates. All USB-847x CAN devices are fully powered from the USB and require no external power supply.

Additionally, USB-847x with Sync series hardware provides a way to synchronize multiple devices by using an external sync connector to share common timing and triggering signals. USB-847x with Sync series hardware can share a timebase with each other or with a variety of data acquisition products.

### CAN: USB-8472, USB-8472s, USB-8473, USB-8473s

- Philips SJA1000 CAN controller. For more specific information about the SJA1000 CAN controller, refer to the [Philips SJA1000 CAN Controller](#) section of Chapter 3, *NI CAN and LIN Hardware*.
- Synchronization via RTSI or any 1/10/20 MHz timebase source. For more information refer to the **ncConnectTerminals** function within the Frame API.
- High-Speed hardware uses the Philips TJA1041 transceiver; Low-Speed/Fault-Tolerant hardware uses the Philips TJA1054A transceiver. Both transceivers have increased voltage tolerance and improved EMC performance over NI CAN Series 1 hardware.

- Low-Speed/Fault-Tolerant CAN support with software selectable bus termination.
- High performance USB 2.0 connection with data transfer rates up to 480 Mbps.
- Fully powered by the USB. No bus power needed.

## LIN: USB-8476, USB-8476s

- Synchronization via RTSI or any 1/10/20 MHz timebase source. For more information refer to the ncConnectTerminals functions within the Frame API.
- Software selectable master/slave termination.
- Amtel ATA6625 LIN transceiver with –27V to 40V LIN bus voltage tolerance.
- High performance USB 2.0 connection with data transfer rates up to 480 Mbps.
- Hardware VBat detection.

## NI-CAN Software Overview

---

The NI-CAN software provides full-featured Application Programming Interfaces (APIs), plus tools for configuration and analysis within National Instruments Measurement & Automation Explorer (MAX). The NI-CAN APIs enable you to develop applications that are customized to the test and simulation requirements.

### MAX

The NI-CAN features within MAX enable you to:

- Verify the installation of the NI CAN hardware.
- Configure software properties for each CAN port.
- Create or import configuration information for the Channel API.
- Interact with the CAN network using various tools.

For more information, refer to Chapter 2, [Installation and Configuration](#).

## Frame API

As described in the [CAN Overview](#) section, the frame is the fundamental unit of data transfer on a CAN network. The NI-CAN Frame API provides a set of functions to write and read CAN frames.

Within the Frame API, the data bytes of each frame are not interpreted, but are transferred in their raw format. For example, you can transmit a data frame by calling a write function with the ID, length, and array of data bytes.

For more information, refer to Chapter 9, [Using the Frame API](#).

## Channel API

A typical CAN data frame contains multiple values encoded as raw fields. Figure 1-8 shows an example set of fields for a 6-byte data frame.

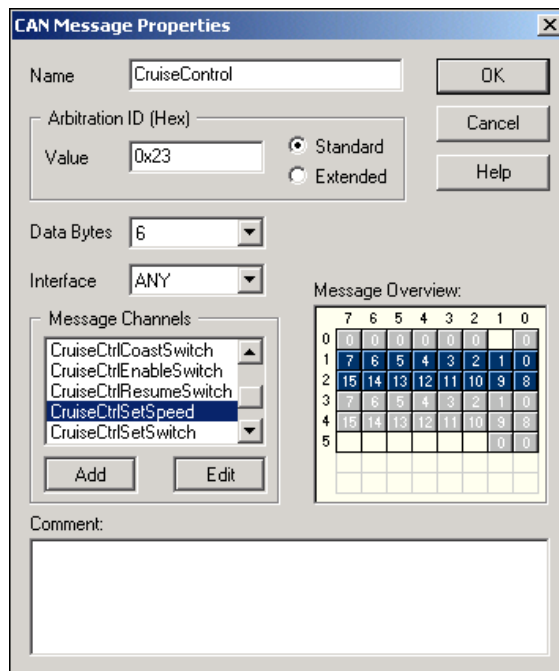

Figure 1-8. Example of CruiseControl Message

Bytes 1 to 2 contain a **CruiseCtrlSetSpeed** field that represents a vehicle speed in kilometers per hour (km/h). Most CAN devices do not transmit values as floating-point units such as 115.6 km/h. Therefore, this field consists of a 16-bit unsigned integer in which each increment represents 0.0039 km/h. For example, if the field contains the value 25000, that represents  $(25000 * 0.0039) = 97.5$  km/h.

Bytes 3 to 4 contain another unsigned integer **VehicleSpeed** that represents speed in km/h. Bytes 0 and 5 contain various Boolean fields for which 1 indicates “on” and 0 indicates “off.”

When you use the NI-CAN Frame API to read CAN data frames, you must write code in the application to convert each raw field to physical units such as km/h. The NI-CAN Channel API enables you to specify this conversion information at configuration time instead of within the application. This configuration information can be imported from Vector CANdb files, or specified directly in MAX.

For each ID you read or write on the CAN network, you specify a number of fields. For each field, you specify its location in the frame, size in bits, and a formula to convert to/from floating-point units. In other words, you specify the meaning of various fields in each CAN data frame. In NI-CAN terminology, a data frame for which the individual fields are described is called a *message*.

In other National Instruments software products such as NI-DAQ, NI-DAQmx, and FieldPoint, an application reads or writes a floating-point value using a *channel*, which is typically converted to/from a raw value in the measurement hardware. The NI-CAN Channel API also uses the term channel to refer to floating-point values converted to/from raw fields in messages. In CAN products of other vendors, this concept is often referred to as a *signal*. When a CAN message is received, NI-CAN converts the raw fields into physical units, which you then obtain using the Channel API read function. When you call the Channel API write function, you provide floating-point values in physical units, which NI-CAN converts into raw fields and transmits as a CAN message.

For more information, refer to Chapter 6, [Using the Channel API](#).

---

# Installation and Configuration

This chapter explains how to install and configure CAN hardware.

## Safety Information

---

The following section contains important safety information that you must follow when installing and using the module.

Do *not* operate the module in a manner not specified in this document. Misuse of the module can result in a hazard. You can compromise the safety protection built into the module if the module is damaged in any way. If the module is damaged, return it to National Instruments (NI) for repair.

Do *not* substitute parts or modify the module except as described in this document. Use the module only with the chassis, modules, accessories, and cables specified in the installation instructions. You *must* have all covers and filler panels installed during operation of the module.

Do *not* operate the module in an explosive atmosphere or where there may be flammable gases or fumes. If you must operate the module in such an environment, it must be in a suitably rated enclosure.

If you need to clean the module, use a soft, nonmetallic brush. Make sure that the module is completely dry and free from contaminants before returning it to service.

Operate the module only at or below Pollution Degree 2. Pollution is foreign matter in a solid, liquid, or gaseous state that can reduce dielectric strength or surface resistivity. The following is a description of pollution degrees:

Pollution Degree 1 means no pollution or only dry, nonconductive pollution occurs. The pollution has no influence.

Pollution Degree 2 means that only nonconductive pollution occurs in most cases. Occasionally, however, a temporary conductivity caused by condensation must be expected.

Pollution Degree 3 means that conductive pollution occurs, or dry, nonconductive pollution occurs that becomes conductive due to condensation.

You *must* insulate signal connections for the maximum voltage for which the module is rated. Do *not* exceed the maximum ratings for the module. Do *not* install wiring while the module is live with electrical signals.

Do *not* remove or add connector blocks when power is connected to the system. Avoid contact between your body and the connector block signal when hot swapping modules. Remove power from signal lines before connecting them to or disconnecting them from the module.

Operate the module at or below the *installation category*<sup>1</sup> marked on the hardware label. Measurement circuits are subjected to *working voltages*<sup>2</sup> and transient stresses (overvoltage) from the circuit to which they are connected during measurement or test. Installation categories establish standard impulse withstand voltage levels that commonly occur in electrical distribution systems. The following is a description of installation categories:

- Installation Category I is for measurements performed on circuits not directly connected to the electrical distribution system referred to as MAINS<sup>3</sup> voltage. This category is for measurements of voltages from specially protected secondary circuits. Such voltage measurements include signal levels, special equipment, limited-energy parts of equipment, circuits powered by regulated low-voltage sources, and electronics.
- Installation Category II is for measurements performed on circuits directly connected to the electrical distribution system. This category refers to local-level electrical distribution, such as that provided by a standard wall outlet (for example, 115 AC voltage for U.S. or 230 AC voltage for Europe). Examples of Installation Category II are measurements performed on household appliances, portable tools, and similar modules.
- Installation Category III is for measurements performed in the building installation at the distribution level. This category refers to measurements on hard-wired equipment such as equipment in fixed installations, distribution boards, and circuit breakers. Other examples

---

<sup>1</sup> Installation categories, also referred to as measurement categories, are defined in electrical safety standard IEC 61010-1.

<sup>2</sup> Working voltage is the highest rms value of an AC or DC voltage that can occur across any particular insulation.

<sup>3</sup> MAINS is defined as a hazardous live electrical supply system that powers equipment. Suitably rated measuring circuits may be connected to the MAINS for measuring purposes.

are wiring, including cables, bus bars, junction boxes, switches, socket outlets in the fixed installation, and stationary motors with permanent connections to fixed installations.

- Installation Category IV is for measurements performed at the primary electrical supply installation (<1,000 V). Examples include electricity meters and measurements on primary overcurrent protection devices and on ripple control units.

## Measurement & Automation Explorer (MAX)

---

Measurement & Automation Explorer (MAX) provides access to all of the National Instruments products. Like other NI software products, NI-CAN uses MAX as the centralized location for all configuration and tools.

To launch MAX, select the **Measurement & Automation** shortcut on the desktop, or within the Windows **Programs** menu under **National Instruments»Measurement & Automation**.

For information on the NI-CAN software within MAX, consult the online help within MAX.

A reference is located in the MAX **Help** menu under **Help Topics»NI-CAN**.

View help for items in the MAX **Configuration** tree by using the built-in MAX help pane. If this help pane is not shown on the far right, select the **Show/Hide** button in the upper right.

View help for a dialog box by selecting the **Help** button in the window.

## Verify Installation of CAN and LIN Hardware

---

Within the **Devices & Interfaces** branch of the MAX Configuration tree, NI CAN and LIN hardware is listed, as shown in Figure 2-1.



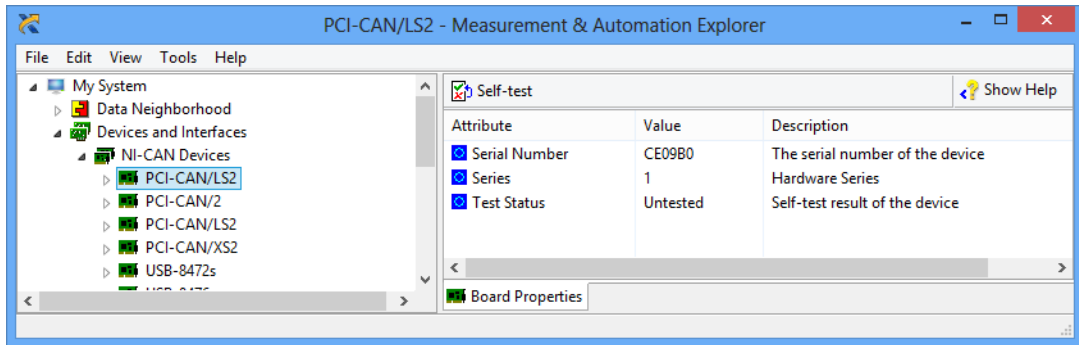

**Figure 2-1.** NI-CAN Cards Listed in MAX

If the CAN or LIN hardware is not listed here, MAX is not configured to search for new devices on startup. To search for the new hardware, press <F5>.

To verify installation of the CAN or LIN hardware, right-click the CAN or LIN device, then select **Self-test**. If the self-test passes, the card icon shows a checkmark. If the self-test fails, the card icon shows an X mark, and the **Test Status** in the right pane describes the problem. Refer to Appendix A, *Troubleshooting and Common Questions*, for information about resolving hardware installation problems.

## Configure CAN and LIN Ports

The physical ports of the CAN and LIN hardware are listed under the name of the device. To configure software properties for each port, right-click the port and select **Properties**.

In the **Properties** dialog, you assign an interface name to the port, such as **CAN0** or **CAN1**. The interface name identifies the physical port within NI-CAN APIs.

The **Properties** dialog also contains the default baud rate for MAX tools and the Channel API.

## CAN Channels

Within the **Data Neighborhood** branch of the MAX Configuration tree, the **CAN Channels** branch lists information for the NI-CAN Channel API, as shown in Figure 2-2.

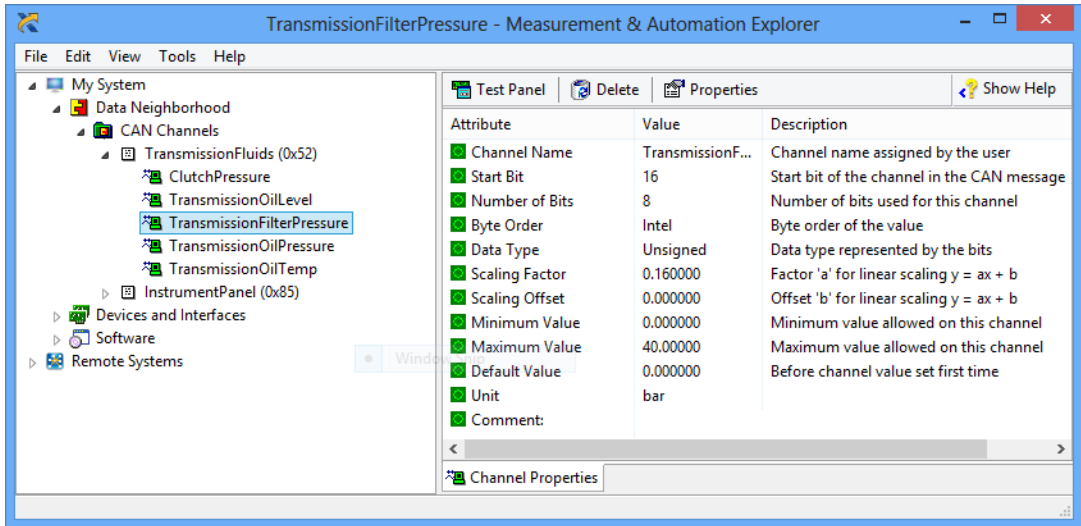

Figure 2-2. CAN Channels in MAX

The **CAN Channels** branch lists CAN messages for use with the Channel API. A set of channels is specified for each message.

For information about creating information under **CAN Channels**, refer to the [Choose Source of Channel Configuration](#) section of Chapter 6, *Using the Channel API*.

## LabVIEW Real-Time (RT) Configuration

LabVIEW Real-Time (RT) combines easy-to-use LabVIEW programming with the power of real-time systems. When you use a National Instruments PXI Controller you can install a PXI-CAN card and use the NI-CAN API to develop real-time applications. For example, you can simulate the behavior of a control algorithm within a CAN device, using data from received CAN messages to generate outgoing CAN messages with deterministic response times. This and other real-time applications can also be developed if you are using CompactRIO as your LabVIEW RT system. You can install a CompactRIO CAN module and use the NI-CAN software and the LabVIEW FPGA I/O to develop your applications.

When you install the NI-CAN software, the installer checks for the presence of the LabVIEW RT module. If LabVIEW RT exists, the NI-CAN installer copies components for LabVIEW RT to the Windows system. As with any other NI product for LabVIEW RT, you then download the

NI-CAN software to the LabVIEW RT system using the **Remote Systems** branch in MAX. For more information, refer to the LabVIEW RT documentation.

USB-847x hardware is not supported under LabVIEW RT.

## PXI System

After you have installed the PXI CAN cards and downloaded the NI-CAN software to the LabVIEW RT system, you need to verify the installation. Within the **Tools** menu in MAX, select **NI-CAN»RT Hardware Configuration**. The RT Hardware Configuration tool provides features similar to **Devices & Interfaces** on the local system. Use the RT Hardware Configuration tool to self-test the CAN cards and assign an interface name to each physical CAN port.

To use the Channel API on the LabVIEW RT system, you must also download channel configuration information. Right-click the **CAN Channels** heading, then select **Send to RT System**. This downloads all information under CAN Channels to the LabVIEW RT system, so you can execute the same LabVIEW VIs on the LabVIEW RT system as on the Windows system.

## CompactRIO System

After you have installed the CompactRIO CAN modules and downloaded NI-RIO and NI-CAN software, you need to enable the CompactRIO Reconfigurable Embedded Chassis for use in LabVIEW. For instructions on how to enable the CompactRIO Reconfigurable Embedded Chassis for use in LabVIEW, refer to the MAX help.

To use the Channel API on the LabVIEW RT system, you must download the channel configuration information. Right-click the **CAN Channels** heading, then select **Send to RT System**. This downloads all the information under CAN Channels to the LabVIEW RT system. To utilize the CAN channels on the CompactRIO system, you need to use Frame to Channel Conversion. For more information, refer to the [Frame to Channel Conversion](#) section of Chapter 6, [Using the Channel API](#).

# Tools

---

NI-CAN provides tools that you can launch from MAX.

- **Bus Monitor**—Displays statistics for CAN or LIN frames. This provides a basic tool to analyze CAN or LIN network traffic. Launch this tool by right-clicking a CAN or LIN interface (port).
- **Test Panel**—Read or write physical units for a CAN channel. This provides a simple debugging tool to experiment with CAN channels. Launch this tool by right-clicking a CAN channel.
- **NI-Spy**—Monitor function calls to the NI-CAN APIs. This tool helps in debugging programming problems in the application. To launch this tool, open the **Software** branch of the MAX Configuration tree, right-click **NI Spy**, and select **Launch NI Spy**.
- **FP1300 Configuration**—FieldPoint 1300 is the National Instruments modular I/O product for CAN. If you have installed the software for the FP1300 product, launch this tool by right-clicking a CAN interface (port).

## Using NI-CAN with NI-DNET

---

DeviceNet is a higher-level protocol based on CAN, typically used for industrial automation or machine control applications. NI-DNET is the National Instruments software for DeviceNet.

NI-CAN uses the same software infrastructure as NI-DNET, so both APIs can be used with the same CAN card. The general rule is that each CAN card can only be used for one API at a time.

Use of NI-DNET is restricted to port 1 (top port) of Series 1 CAN cards. National Instruments hardware kits for CAN ship with Series 2 cards, which cannot be used with NI-DNET. National Instruments hardware kits for DeviceNet ship with Series 1 cards, which can be used with both NI-DNET and NI-CAN. For information on identification of the series, refer to the [NI CAN Hardware Overview](#) section of Chapter 1, [Introduction](#).

You can view each Series 1 CAN card in MAX with either DeviceNet or CAN features. To change the view of a CAN card in MAX, right-click the card and select **Protocol**. In this dialog you can select either DeviceNet for NI-DNET, or CAN for NI-CAN. When the CAN protocol is selected, you can access CAN tools in MAX, such as the **Bus Monitor** tool.

In order to develop NI-DNET applications, you must install NI-DNET components such as documentation and examples. The NI-DNET software components are available within the NI-CAN installer.

Launch the `setup.exe` program for the NI-CAN installer in the same manner as the original installation (CD or `ni.com` download). Within the installer, select both NI-DNET and NI-CAN components in the feature tree.

When you right-click a port in MAX and select **Properties**, the resulting **Interface** selection uses the syntax **CAN $x$**  or **DNET $x$**  based on the protocol selection. Regardless of which protocol is selected, the number  $x$  is the only relevant identifier with respect to NI-CAN and NI-DNET functions. For example, if you select **DNET0** as an interface in MAX, you can run an NI-DNET application that uses **DNET0**, then you can run an NI-CAN application that uses **CAN0**. Both applications refer to the same port, and can run at different times, but not simultaneously.

---

# NI CAN and LIN Hardware

This chapter describes the NI CAN Series 2 and USB-847x hardware.

## Philips SJA1000 CAN Controller

---

All NI CAN Series 2 and USB-847x CAN hardware uses the Philips SJA1000 controller to implement the CAN protocol. This chip is CAN 2.0B compatible, and supports both 11-bit and 29-bit identifiers. Using the NI-CAN software package with the SJA1000 enables features such as:

- **Listen only mode**—In this mode, the CAN controller does not provide an acknowledge signal on the bus, even if a message is received successfully. This mode is useful for passively monitoring a CAN bus. This feature is provided as the Listen Only attribute of the Frame API and the Interface Listen Only property of the Channel API.
- **64-byte receive FIFO**—Helps prevent data overrun errors.
- **Single/dual acceptance filter**—Allows flexible filtering of CAN messages through programming of acceptance mask and comparator registers. This feature is provided as the Series 2 Filter Mode attribute of the Frame API and the Interface Series 2 Filter Mode property of the Channel API.
- **Self-reception request**—When enabled, a successfully transmitted message is received simultaneously. This feature is provided as the Self Reception attribute of the Frame API and the Interface Self Reception property of the Channel API.
- **Read/Write access to error counters**—These counters are provided as the Receive (and Transmit) Error Counter attribute of the Frame API, and the Interface Receive (and Transmit) Error Counter property of the Channel API.

# PCI-CAN

---

## High-Speed Physical Layer

The CAN physical layer circuitry interfaces the CAN protocol controller to the physical bus wires. The PCI-CAN High-Speed physical layer is powered internally (from the card) through a DC-DC converter, and is optically isolated up to 60 V<sub>DC</sub> (continuous) channel-to-bus. This isolation protects the NI CAN hardware and the PC it is installed in from being damaged by high-voltage spikes on the CAN bus.

### Transceiver

PCI-CAN High-Speed hardware uses the Philips TJA1041 High-Speed CAN transceiver. The TJA1041 is fully compatible with the ISO 11898 standard and supports baud rates up to 1 Mbps. This device also supports advanced power management through a low-power sleep mode. This feature is provided as the **Transceiver Mode** attribute of the Frame API and the **Interface Transceiver Mode** property of the Channel API. For detailed TJA1041 specifications, refer to the Philips TJA1041 data sheet.

### Bus Power Requirements

Because the High-Speed physical layer is completely powered internally, there is no need to supply bus power. The V<sub>-</sub> signal serves as the reference ground for the isolated signals. Refer to the [High-Speed PCI, PXI, and USB Connector Pinout](#) section of Chapter 4, [Connectors and Cables](#), for information about how to connect signals to a High-Speed CAN interface.

### VBAT Jumper

The TJA1041 features a battery voltage input pin, VBAT. This signal can be supplied either internally or externally through the CAN bus V<sub>+</sub> signal, as controlled by the VBAT jumper setting. By default, the jumper is set to INT, and VBAT is supplied internally. Some applications may require explicit control of the transceiver VBAT pin; for example, to test the performance of CAN devices on a network where battery power is lost. If external control of VBAT is required, you can configure the PCI-CAN hardware by switching the VBAT jumper from its default INT position to EXT, as shown in Figure 3-1.

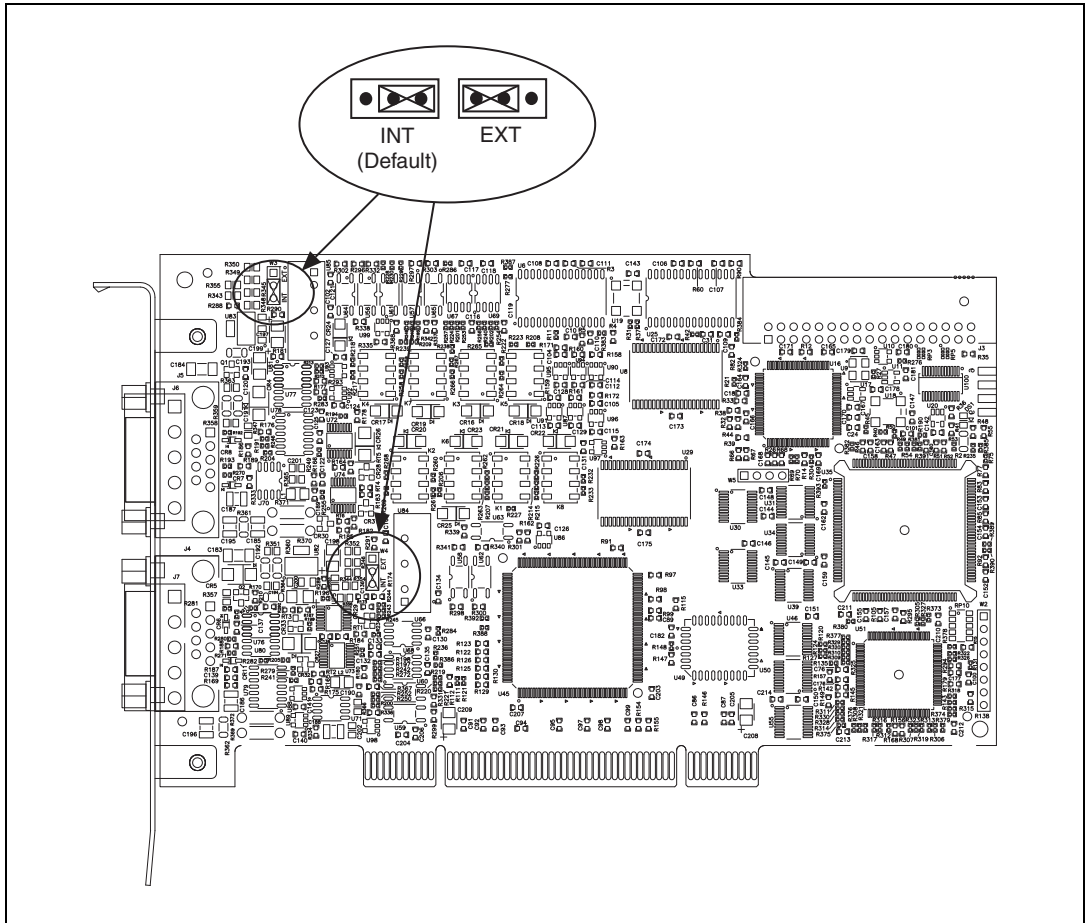

**Figure 3-1.** High-Speed VBAT Jumper Settings

With the VBAT jumper set to EXT, you must supply power on the CAN V+ signal. The power supply should be a DC power supply with an output of 8 to 27 V, as specified in Table 3-1. You should take these requirements into account when determining the bus power supply requirements for the system.



**Table 3-1.** CAN V+ Signal Power Supply

Characteristic	Specification
Voltage	8–27 VDC on V+ connector pin (referenced to V–)
Current	30 $\mu$ A typical 40 $\mu$ A maximum

If you are unsure how to configure VBAT, leave the jumper set to its default value, INT.

## Low-Speed/Fault-Tolerant Physical Layer

The PCI-CAN Low-Speed/Fault-Tolerant physical layer is powered internally (from the card) through a DC-DC converter, and is optically isolated up to 60 V<sub>DC</sub> (continuous) channel-to-bus. This isolation protects the NI CAN hardware and the PC it is installed in from being damaged by high-voltage spikes on the CAN bus.

### Transceiver

PCI-CAN Low-Speed/Fault-Tolerant hardware uses the Philips TJA1054A Low-Speed/Fault-Tolerant transceiver. The TJA1054A supports baud rates up to 125 kbps. The transceiver can detect and automatically recover from the following CAN bus failures:

- CAN\_H wire interrupted
- CAN\_L wire interrupted
- CAN\_H short-circuited to battery
- CAN\_L short-circuited to battery
- CAN\_H short-circuited to VCC
- CAN\_L short-circuited to VCC
- CAN\_H short-circuited to ground
- CAN\_L short-circuited to ground
- CAN\_H and CAN\_L mutually short-circuited

The TJA1054A supports advanced power management through a low-power sleep mode. This feature is provided as the **Transceiver Mode** attribute of the Frame API and the **Interface Transceiver Mode** property of the Channel API. For detailed specifications about the TJA1054A, refer to the Philips TJA1054 data sheet.

## Bus Power Requirements

Because the Low-Speed/Fault-Tolerant physical layer is completely powered internally, there is no need to supply bus power. The V– signal serves as the reference ground for the isolated signals. Refer to the [Low-Speed/Fault-Tolerant PCI, PXI, and USB Connector Pinout](#) section of Chapter 4, [Connectors and Cables](#), for information about how to connect signals to a Low-Speed/Fault-Tolerant CAN interface.

## VBAT Jumper

The TJA1054A features a battery voltage input pin, VBAT. This signal can be supplied either internally or externally through the CAN bus V+ signal, as controlled by the VBAT jumper setting. By default, the jumper is set to INT, and VBAT is supplied internally. Some applications may require explicit control of the transceiver VBAT pin; for example, to test the performance of CAN devices on a network where battery power is lost. If external control of VBAT is required, you can configure the PCI-CAN hardware by switching the VBAT jumper from its default INT position to EXT, as shown in Figure 3-2, [Low-Speed/Fault-Tolerant VBAT Jumper Settings](#).

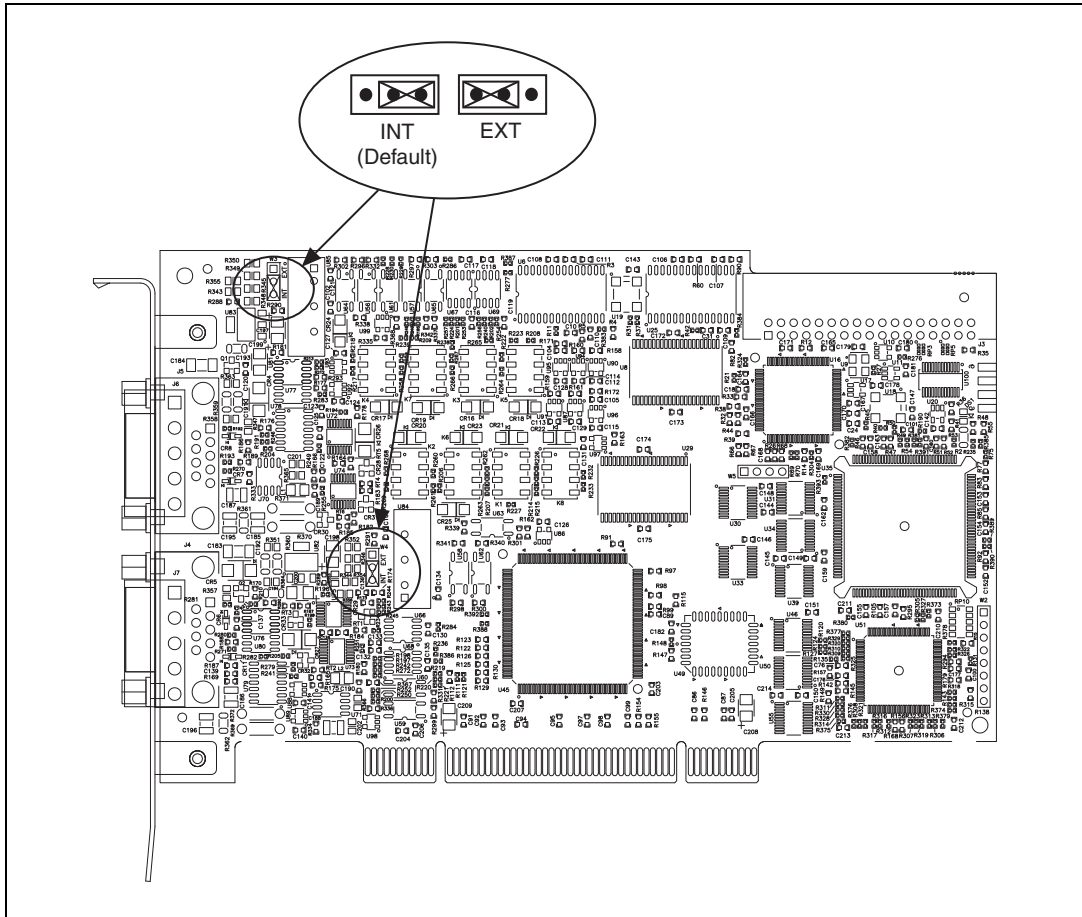

Figure 3-2. Low-Speed/Fault-Tolerant VBAT Jumper Settings

## Low-Speed/Fault-Tolerant VBAT Jumper Settings

With the VBAT jumper set to EXT, you must supply power on the CAN V+ signal. The power supply should be a DC power supply with an output of 8 to 27 V, as specified in Table 3-2, [CAN V+ Signal Power Supply](#). You should take these requirements into account when determining the bus power supply requirements for the system.

**Table 3-2.** CAN V+ Signal Power Supply

Characteristic	Specification
Voltage	8–27 VDC on V+ connector pin (referenced to V–)
Current	30 $\mu$ A typical 125 $\mu$ A maximum

If you are unsure how to configure VBAT, leave the jumper set to its default value, INT.

## Single Wire Physical Layer

The Single Wire physical layer is powered internally (from the card) through a DC-DC converter. However, the Single Wire CAN transceiver does require bus power. The physical layer is optically isolated up to 60 V<sub>DC</sub> (continuous) channel-to-bus. This isolation protects the NI CAN hardware and the PC it is installed in from being damaged by high-voltage spikes on the CAN bus.

## Transceiver

Single Wire hardware uses the Philips AU5790 Single Wire CAN transceiver. The AU5790 supports baud rates up to 33.3 kbps in normal transmission mode and 83.3 kbps in High-Speed transmission mode. The achievable baud rate is primarily a function of the network characteristics (termination and number of nodes on the bus), and assumes bus loading as per SAE J2411. Each Single Wire CAN port has a local bus load resistance of 9.09 k $\Omega$  between the CAN\_H and RTH pins of the transceiver to provide protection against the loss of ground. The AU5790 also supports advanced power management through low-power sleep and wake-up modes. For detailed AU5790 specifications, refer to the Philips AU5790 data sheet.

## Bus Power Requirements

The Single Wire physical layer requires external bus power to provide the signal levels necessary to fully use all AU5790 operating modes. This is because some modes require higher signal levels than the internal DC/DC converter on the PCI-CAN board can provide. You must supply power on the CAN V+ signal. The power supply should be a DC power supply with an output of 8 to 18 V, as specified in Table 3-3, *CAN V+ Signal Power Supply*. A power supply of 12 VDC is recommended. You should take these requirements into account when determining requirements of the bus power supply for the system.

**Table 3-3.** CAN V+ Signal Power Supply

Characteristic	Specification
Voltage	8–18 VDC (12 VDC typical) on V+ connector pin (referenced to V–)
Current	40 mA typical 90 mA maximum

## VBAT Jumper

Because the AU5790 requires external bus power, there is no option to power the VBAT signal internally. For this reason, the VBAT jumper is not present on Single Wire hardware, and external bus power must be provided.

## XS Software Selectable Physical Layer

PCI-CAN/XS hardware allows you to select each port individually in the physical layer for one of the following transceivers:

- High-Speed
- Low-Speed/Fault-Tolerant
- Single Wire
- External

When an XS port is selected as High-Speed, it behaves exactly as a dedicated High-Speed interface with the TJA1041 transceiver.

When an XS port is selected as Low-Speed/Fault-Tolerant, it behaves exactly as a dedicated Low-Speed/Fault-Tolerant interface with the TJA1054A transceiver.

When an XS port is selected as Single Wire, it behaves exactly as a dedicated Single Wire interface with the AU5790 transceiver.

Note that the bus power requirements and VBAT jumper setting for an XS port depend on the mode selected. Refer to the appropriate High-Speed, Low-Speed/Fault-Tolerant, or Single Wire physical layer section to determine the behavior for the mode selected. For example, the bus power requirements and VBAT jumper operation for an XS port configured for Single Wire mode are identical to those of a dedicated Single Wire node.

When an XS port is selected as external, all onboard transceivers are bypassed, and the CAN controller RX, TX, and mode/status control signals are routed directly to the I/O connector. Refer to the [XS PCI and PXI](#)

*Connector Pinout* section of Chapter 4, *Connectors and Cables*, for information about how to connect signals to an XS CAN interface.

External mode is intended for interfacing custom physical layer circuits to NI CAN hardware. For example, to use a particular CAN transceiver that is not supported natively by the NI CAN hardware, you can use an XS port configured for external mode to connect to the custom-built transceiver circuit and access the bus as usual using NI-CAN software. In addition to the CAN controller RX and TX signals, you also can control two MODE output pins and one STATUS input pin on an external mode port. These MODE and STATUS signals are useful for controlling the operating mode of the custom physical layer and monitoring for any error conditions on the bus. These pins are provided in software as the **Transceiver External Outputs (and Inputs)** attribute of the Frame API and the **Interface Transceiver External Outputs (and Inputs)** property of the Channel API.

Because power is not routed through the connector of an XS port, an external transceiver circuit requires bus power to be supplied.

You can change the transceiver type within MAX using the **Properties** dialog for each port. The transceiver type selected within MAX is used as the default for NI-CAN applications. The initial transceiver configuration in MAX is High-Speed for Port 1 and Low-Speed/Fault-Tolerant for Port 2.

You also can change the transceiver type within the application, which overrides the value in MAX. This feature is provided as the **Transceiver Type** attribute of the Frame API, and the **Interface Transceiver Type** property of the Channel API.

## RTSI

The RTSI bus gives you the ability to synchronize multiple NI CAN cards with other National Instruments hardware products such as DAQ, IMAQ, and Motion. The RTSI bus consists of a flexible interconnect scheme for sharing timing and triggering signals in a system.

For PCI hardware, the RTSI bus interface is a connector at the top of the card, and you can synchronize multiple cards by connecting a RTSI ribbon cable between the cards that need to share timing and triggering signals. Figure 3-3 shows the RTSI signal interconnect architecture for NI PCI-CAN hardware.

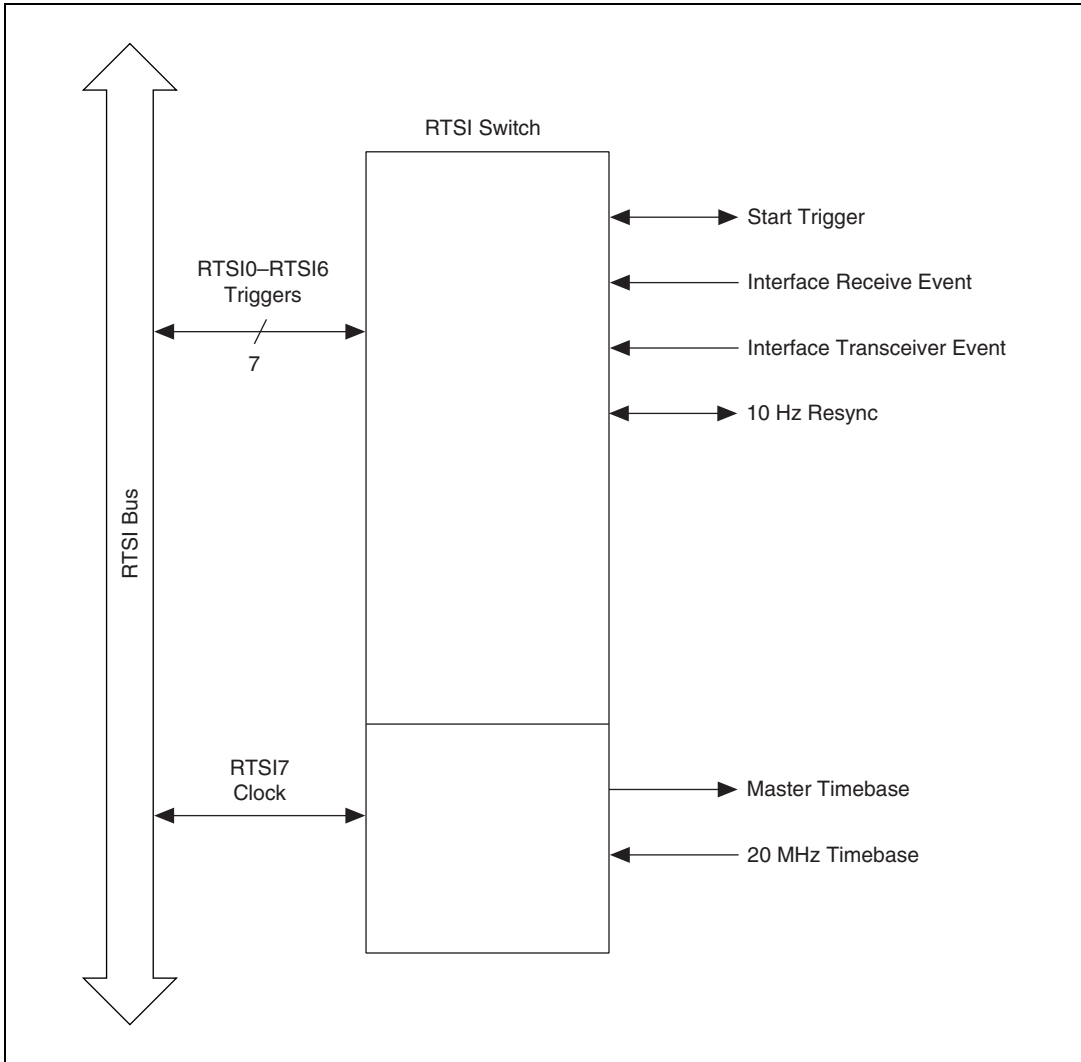

**Figure 3-3.** RTSI Signal Interconnect Architecture for NI PCI-CAN Hardware

Refer to [CAN Connect Terminals.vi](#) for a description of the RTSI signals.

# PXI-846x

---

This section describes the PXI-846x hardware.

## High-Speed Physical Layer

The CAN physical layer circuitry interfaces the CAN protocol controller to the physical bus wires. The PXI-8461 physical layer is powered internally (from the card) through a DC-DC converter, and is optically isolated up to 60 V<sub>DC</sub> (continuous) channel-to-bus. This isolation protects the NI CAN hardware and the PC it is installed in from being damaged by high-voltage spikes on the CAN bus.

### Transceiver

PXI-8461 hardware uses the Philips TJA1041 High-Speed CAN transceiver. The TJA1041 is fully compatible with the ISO 11898 standard and supports baud rates up to 1 Mbps. This device also supports advanced power management through a low-power sleep mode. This feature is provided as the **Transceiver Mode** attribute of the Frame API and the **Interface Transceiver Mode** property of the Channel API. For detailed TJA1041 specifications, refer to the Philips TJA1041 data sheet.

### Bus Power Requirements

Because the High-Speed physical layer is completely powered internally, there is no need to supply bus power. The V<sub>-</sub> signal serves as the reference ground for the isolated signals. Refer to the [High-Speed PCI, PXI, and USB Connector Pinout](#) section of Chapter 4, [Connectors and Cables](#), for information about how to connect signals to a High-Speed CAN interface.

### VBAT Jumper

The TJA1041 features a battery voltage input pin, VBAT. This signal can be supplied either internally or externally through the CAN bus V<sub>+</sub> signal, as controlled by the VBAT jumper setting. By default, the jumper is set to INT, and VBAT is supplied internally. Some applications may require explicit control of the transceiver VBAT pin; for example, to test the performance of CAN devices on a network where battery power is lost. If external control of VBAT is required, you can configure the PXI-8461 hardware by switching the VBAT jumper from its default INT position to EXT, as shown in Figure 3-4, [High-Speed VBAT Jumper Settings](#).



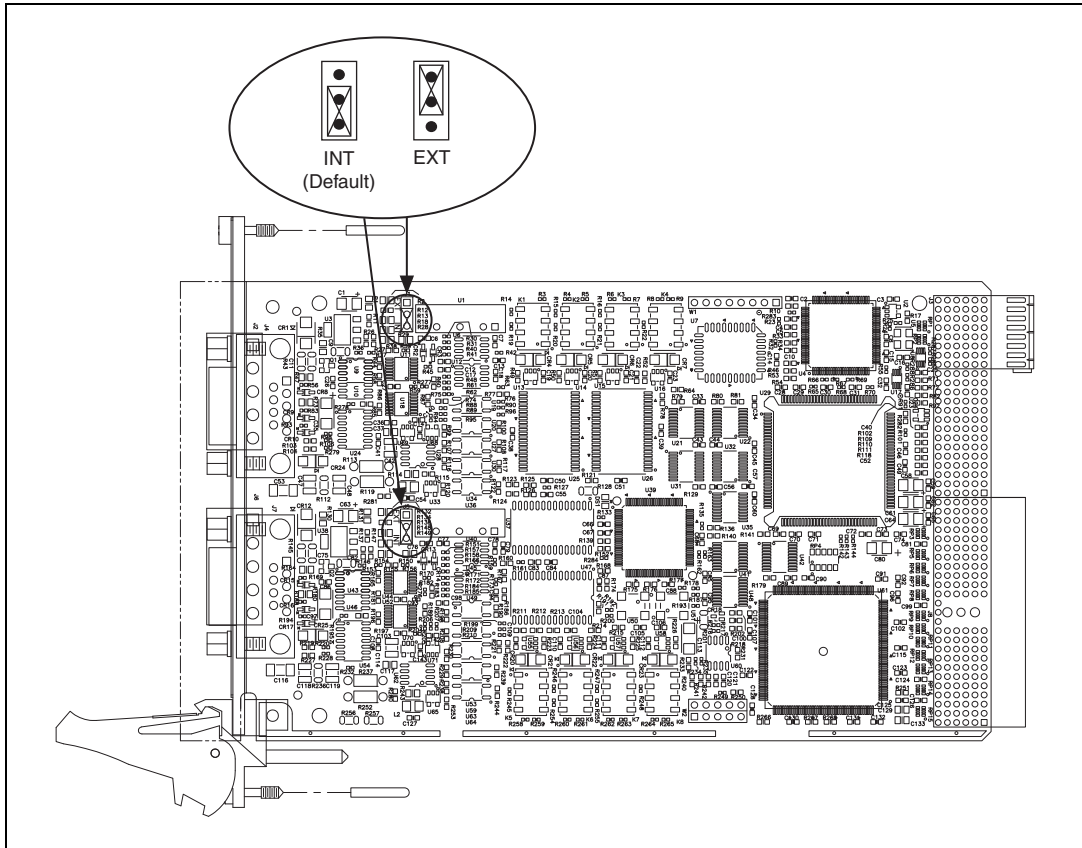

**Figure 3-4.** High-Speed VBAT Jumper Settings

With the VBAT jumper set to EXT, you must supply power on the CAN V+ signal. The power supply should be a DC power supply with an output of 8 to 27 V, as specified in Table 3-4. You should take these requirements into account when determining requirements of the bus power supply for the system.

**Table 3-4.** CAN V+ Signal Power Supply

Characteristic	Specification
Voltage	8–27 VDC on V+ connector pin (referenced to V–)
Current	30 $\mu$ A typical 40 $\mu$ A maximum

If you are unsure how to configure VBAT, leave the jumper set to its default value, INT.

## Low-Speed/Fault-Tolerant Physical Layer

The PXI-8460 physical layer is powered internally (from the card) through a DC-DC converter, and is optically isolated up to 60 V<sub>DC</sub> (continuous) channel-to-bus. This isolation protects the NI CAN hardware and the PC it is installed in from being damaged by high-voltage spikes on the CAN bus.

### Transceiver

PXI-8460 hardware uses the Philips TJA1054A Low-Speed/Fault-Tolerant transceiver. The TJA1054A supports baud rates up to 125 kbps. The transceiver can detect and automatically recover from the following CAN bus failures:

- CAN\_H wire interrupted
- CAN\_L wire interrupted
- CAN\_H short-circuited to battery
- CAN\_L short-circuited to battery
- CAN\_H short-circuited to VCC
- CAN\_L short-circuited to VCC
- CAN\_H short-circuited to ground
- CAN\_L short-circuited to ground
- CAN\_H and CAN\_L mutually short-circuited

The TJA1054A supports advanced power management through a low-power sleep mode. This feature is provided as the **Transceiver Mode** attribute of the Frame API and the **Interface Transceiver Mode** property of the Channel API. For detailed TJA1054A specifications, refer to the Philips TJA1054 data sheet.

### Bus Power Requirements

Because the Low-Speed/Fault-Tolerant physical layer is completely powered internally, there is no need to supply bus power. The V– signal serves as the reference ground for the isolated signals. Refer to the [Low-Speed/Fault-Tolerant PCI, PXI, and USB Connector Pinout](#) section of Chapter 4, [Connectors and Cables](#), for information about how to connect signals to a Low-Speed/Fault-Tolerant CAN interface.

## VBAT Jumper

The TJA1054A features a battery voltage input pin, VBAT. This signal can be supplied either internally or externally through the CAN bus V+ signal, as controlled by the VBAT jumper setting. By default, the jumper is set to INT, and VBAT is supplied internally. Some applications may require explicit control of the transceiver VBAT pin; for example, to test the performance of CAN devices on a network where battery power is lost. If external control of VBAT is required, you can configure the PXI-8460 hardware by switching the VBAT jumper from its default INT position to EXT, as shown in Figure 3-5.

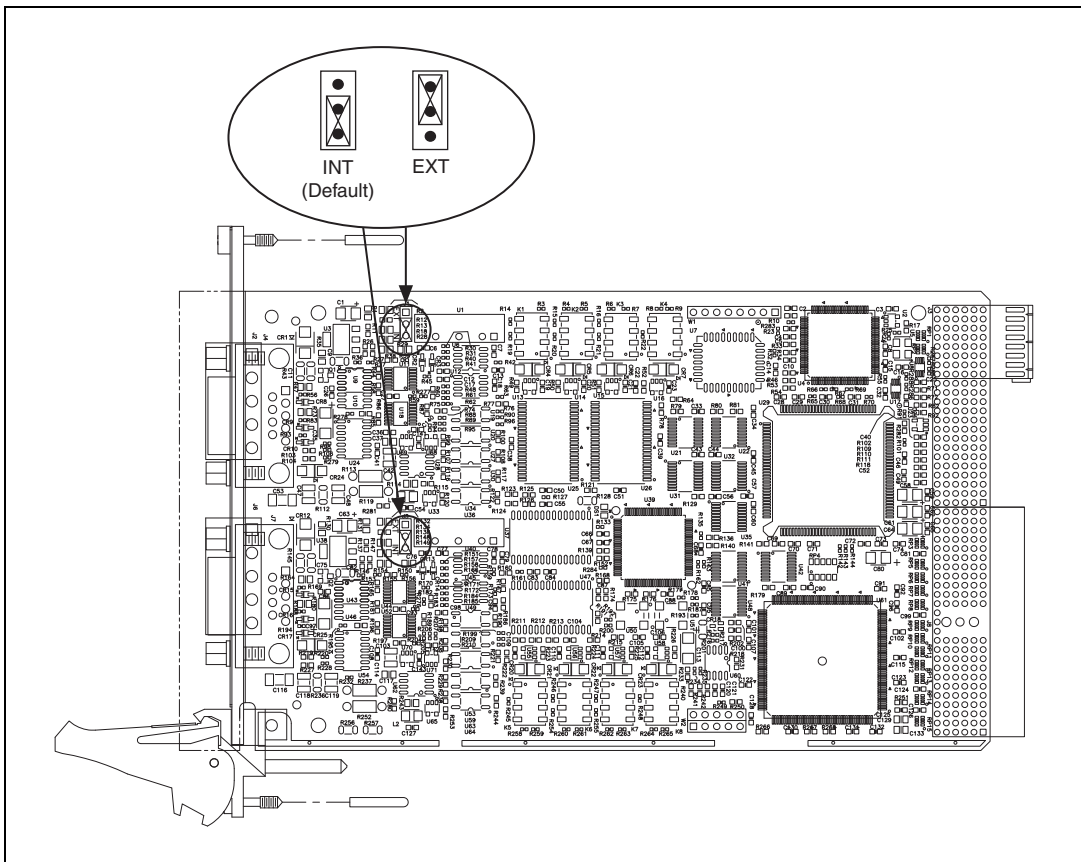

**Figure 3-5.** Low-Speed/Fault-Tolerant VBAT Jumper Settings

With the VBAT jumper set to EXT, you must supply power on the CAN V+ signal. The power supply should be a DC power supply with an output of 8 to 27 V, as specified in Table 3-5. You should take these requirements into account when determining the bus power supply requirements for the system.

**Table 3-5.** CAN V+ Signal Power Supply

Characteristic	Specification
Voltage	8–27 VDC on V+ connector pin (referenced to V–)
Current	30 $\mu$ A typical 125 $\mu$ A maximum

If you are unsure how to configure VBAT, leave the jumper set to its default value, INT.

## Single Wire Physical Layer

The Single Wire physical layer is powered internally (from the card) through a DC-DC converter. However, the Single Wire CAN transceiver does require bus power. The physical layer is optically isolated up to 60 V<sub>DC</sub> (continuous) channel-to-bus. This isolation protects the NI CAN hardware and the PC it is installed in from being damaged by high-voltage spikes on the CAN bus.

## Transceiver

Single Wire hardware uses the Philips AU5790 Single Wire CAN transceiver. The AU5790 supports baud rates up to 33.3 kbps in normal transmission mode and 83.3 kbps in High-Speed transmission mode. The achievable baud rate is primarily a function of the network characteristics (termination and number of nodes on the bus), and assumes bus loading as per SAE J2411. Each Single Wire CAN port has a local bus load resistance of 9.09 k $\Omega$  between the CAN\_H and RTH pins of the transceiver to provide protection against the loss of ground. The AU5790 also supports advanced power management through low-power sleep and wake-up modes. For detailed specifications of the AU5790, refer to the Philips AU5790 data sheet.

## Bus Power Requirements

The Single Wire physical layer requires external bus power to provide the signal levels necessary to fully use all operating modes of the AU5790. This is because some modes require higher signal levels than the internal DC-DC converter on the PXI-8463 board can provide. You must supply power on the CAN V+ signal. The power supply should be a DC power supply with an output of 8 V to 18 V, as specified in Table 3-6. A power supply of 12 VDC is recommended. You should take these requirements into account when determining the bus power supply requirements for the system.

**Table 3-6.** CAN V+ Signal Power Supply

Characteristic	Specification
Voltage	8–18 VDC (12 VDC typical) on V+ connector pin (referenced to V–)
Current	40 mA typical 90 mA maximum

## VBAT Jumper

Because the AU5790 requires external bus power, there is no option to power the VBAT signal internally. For this reason, the VBAT jumper is not present on Single Wire hardware, and external bus power must be provided.

## XS Software Selectable Physical Layer

PXI-8464 hardware allows each port in the physical layer to be individually selected for one of the following transceivers:

- High-Speed
- Low-Speed/Fault-Tolerant
- Single Wire
- External

When an XS port is selected as **High-Speed**, it behaves exactly as a dedicated High-Speed interface with the TJA1041 transceiver.

When an XS port is selected as **Low-Speed/Fault-Tolerant**, it behaves exactly as a dedicated Low-Speed/Fault-Tolerant interface with the TJA1054A transceiver.

When an XS port is selected as **Single Wire**, it behaves exactly as a dedicated Single Wire interface with the AU5790 transceiver.

The bus power requirements and VBAT jumper setting for an XS port depend on the mode selected. Refer to the appropriate High-Speed, Low-Speed/Fault-Tolerant, or Single Wire physical layer section to determine the behavior for the mode selected. For example, the bus power requirements and VBAT jumper operation for an XS port configured for **Single Wire** mode are identical to those of a dedicated Single Wire node.

When an XS port is selected as external, all onboard transceivers are bypassed, and the CAN controller RX, TX, and mode/status control signals are routed directly to the I/O connector. Refer to the *XS PCI and PXI Connector Pinout* section of Chapter 4, *Connectors and Cables*, for information about how to connect signals to an XS CAN interface.

**External** mode is intended for interfacing custom physical layer circuits to NI CAN hardware. For example, to use a particular CAN transceiver that is not supported natively by the NI CAN hardware, you can use an XS port configured for external mode to connect to the custom-built transceiver circuit and access the bus as usual using NI CAN software. In addition to the CAN controller RX and TX signals, you also can control two MODE output pins and one STATUS input pin on an external mode port. These MODE and STATUS signals are useful for controlling the operating mode of the custom physical layer and monitoring for any error conditions on the bus. These pins are provided in software as the **Transceiver External Outputs (and Inputs)** attribute of the Frame API and the **Interface Transceiver External Outputs (and Inputs)** property of the Channel API.

Because power is not routed through the connector of an XS port, an external transceiver circuit requires bus power to be supplied.

You can change the transceiver type within MAX using the Properties dialog for each port. The transceiver type selected within MAX is used as the default for NI-CAN applications. The initial transceiver configuration in MAX is **High-Speed** for Port 1 and **Low-Speed/Fault-Tolerant** for Port 2.

You also can change the transceiver type within the application, which overrides the value in MAX. This feature is provided as the **Transceiver Type** attribute of the Frame API, and the **Interface Transceiver Type** property of the Channel API.

## PXI Trigger Bus (RTSI)

The PXI trigger bus provides the ability to synchronize multiple NI CAN cards with other National Instruments hardware products such as DAQ, IMAQ, and Motion. The PXI trigger bus consists of a flexible interconnect scheme for sharing timing and triggering signals in a system. For PXI hardware, the PXI trigger bus is built into the chassis backplane, so all devices in the same PXI chassis can share timing and triggering signals. The functionality of the PXI trigger bus is very similar to the RTSI bus for PCI hardware, with a few added features. In addition to the bused PXI triggers, the PXI bus includes an independent **PXI\_Star** trigger for each slot in a chassis that is oriented in a star configuration from the star trigger slot (slot 2). The star configuration makes **PXI\_Star** well suited for applications that require a trigger signal with very low skew between slots. PXI-846x hardware can route this **PXI\_Star** trigger to its start trigger signal. The **PXI\_Clk10** signal is a 10 MHz timebase signal in a PXI chassis. PXI-846x hardware can use this **PXI\_Clk10** signal as its master timebase for synchronization. Figure 3-6, [RTSI Signal Interconnect Architecture for NI PXI CAN Hardware](#), shows the RTSI signal interconnect architecture for NI PXI CAN hardware.

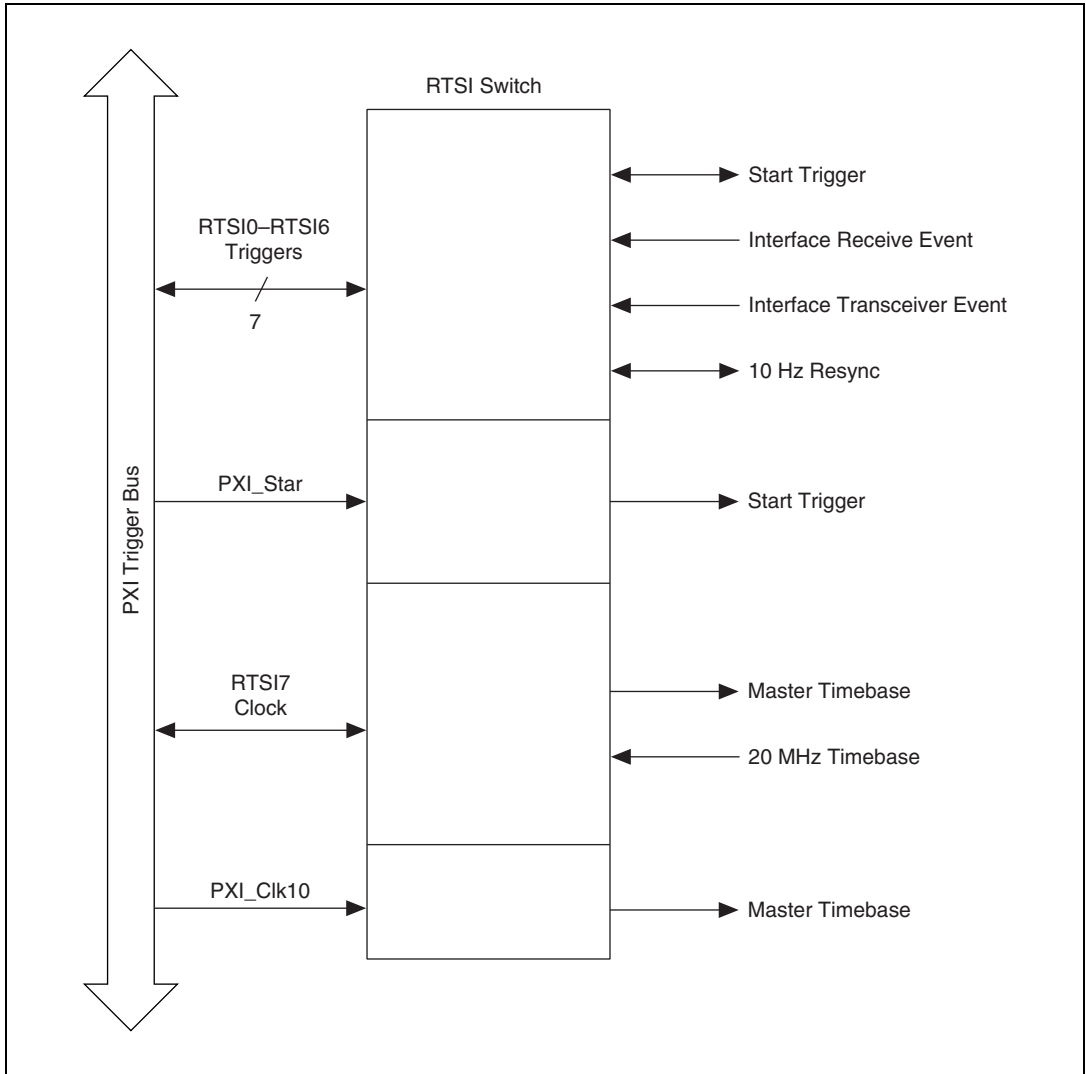

**Figure 3-6.** RTSI Signal Interconnect Architecture for NI PXI CAN Hardware

Refer to [CAN Connect Terminals.vi](#) for a description of the RTSI signals.



## PCMCIA-CAN

---

For PCMCIA-CAN cards, the physical layer is implemented inside the cable.

The three types of physical layers available for PCMCIA-CAN cards are:

- High-Speed
- Low-Speed/Fault-Tolerant
- Single Wire

The High-Speed and Low-Speed/Fault Tolerant cables are powered internally through an onboard DC-DC converter. The Single Wire cables must be powered externally, through the CAN bus.

### PCMCIA-CAN High-Speed Cables

The PCMCIA-CAN High-Speed physical layer is powered internally (from the card through a DC-DC converter), and is optically isolated up to 60 V<sub>DC</sub> (continuous) channel-to-bus. This isolation protects the NI CAN hardware and the PC it is installed in from being damaged by high-voltage spikes on the CAN bus.

### Transceiver

PCMCIA-CAN High-Speed hardware uses the Philips TJA1041 High-Speed CAN transceiver. The TJA1041 is fully compatible with the ISO 11898 standard and supports baud rates up to 1 Mbps. This device also supports advanced power management through a low-power sleep mode. This feature is provided as the **Transceiver Mode** attribute of the Frame API and the **Interface Transceiver Mode** property of the Channel API. For detailed TJA1041 specifications, refer to the Philips TJA1041 data sheet.

### Bus Power Requirements

Because the High-Speed physical layer is completely powered internally, there is no need to supply bus power. The V<sub>-</sub> signal serves as the reference ground for the isolated signals. Refer to the [PCMCIA Connector Pinout](#) section of Chapter 4, [Connectors and Cables](#), for information about how to connect signals to a High-Speed CAN interface.

## PCMCIA-CAN Low-Speed/Fault-Tolerant Cables

The PCMCIA-CAN/LS cable physical layer is powered internally (from the card) through a DC-DC converter, and is optically isolated up to 60 V<sub>DC</sub> (continuous) channel-to-bus. This isolation protects the NI CAN hardware and the PC it is installed in from being damaged by high-voltage spikes on the CAN bus.

### Transceiver

PCMCIA-CAN Low-Speed/Fault-Tolerant hardware uses the Philips TJA1054A Low-Speed/Fault-Tolerant transceiver. The TJA1054A supports baud rates up to 125 kbps. The transceiver can detect and automatically recover from the following CAN bus failures:

- CAN\_H wire interrupted
- CAN\_L wire interrupted
- CAN\_H short-circuited to battery
- CAN\_L short-circuited to battery
- CAN\_H short-circuited to VCC
- CAN\_L short-circuited to VCC
- CAN\_H short-circuited to ground
- CAN\_L short-circuited to ground
- CAN\_H and CAN\_L mutually short-circuited

The TJA1054A supports advanced power management through a low-power sleep mode. This feature is provided as the **Transceiver Mode** attribute of the Frame API and the **Interface Transceiver Mode** property of the Channel API. For detailed specifications about the TJA1054A, refer to the Philips TJA1054 data sheet.

### Bus Power Requirements

Because the PCMCIA-CAN/LS cable is completely powered internally, there is no need to supply bus power. The V<sub>-</sub> signal serves as the reference ground for the isolated signals. Refer to the [PCMCIA Connector Pinout](#) section of Chapter 4, [Connectors and Cables](#), for information about how to connect signals to a Low-Speed/Fault-Tolerant CAN interface.

## PCMCIA-CAN Single Wire Cables

The PCMCIA-CAN Single Wire physical layer is powered externally from the CAN bus. The physical layer is optically isolated up to 60 V<sub>DC</sub> (continuous) channel-to-bus. This isolation protects the NI CAN hardware and the PC in which it is installed from being damaged by high-voltage spikes on the CAN bus.

### Transceiver

PCMCIA-CAN Single Wire hardware uses the Philips AU5790 Single Wire CAN transceiver. The AU5790 supports baud rates up to 33.3 kbps in normal transmission mode and 83.3 kbps in High-Speed transmission mode. The achievable baud rate is primarily a function of the network characteristics (termination and number of nodes on the bus), and assumes bus loading as per SAE J2411. Each Single Wire CAN port has a local bus load resistance of 9.09 k $\Omega$  between the CAN\_H and RTH pins of the transceiver to provide protection against the loss of ground. The AU5790 also supports advanced power management through low-power sleep and wake-up modes. For detailed AU5790 specifications, refer to the Philips AU5790 data sheet.

### Bus Power Requirements

The Single Wire physical layer requires external bus power to provide the signal levels necessary to fully use all AU5790 operating modes. You must supply power on the CAN V+ signal. The power supply should be a DC power supply with an output of 8 to 18 V, as specified in Table 3-7. A power supply of 12 VDC is recommended. You should take these requirements into account when determining requirements of the bus power supply for the system.

**Table 3-7.** CAN V+ Signal Power Supply

Characteristic	Specification
Voltage	8–18 VDC (12 VDC typical) on V+ connector pin (referenced to V–)
Current	40 mA typical 90 mA maximum

## Synchronization

The PCMCIA-CAN synchronization cable provides the ability to synchronize a Series 2 PCMCIA-CAN card with other National Instruments hardware or external devices. The synchronization cable provides a flexible interconnect scheme for sharing timing and triggering signals in a system. For example, PCMCIA-CAN synchronization is specifically designed to integrate well with National Instruments E Series DAQCard hardware. Timing and triggering signals can be shared by wiring the synchronization cable signals to the appropriate terminals on a DAQ terminal block.

The functionality of the PCMCIA-CAN synchronization cable is very similar to the RTSI bus for PCI hardware, with a few limitations:

- Four general-purpose I/O trigger lines, as opposed to seven for RTSI
- TRIG7\_CLK clock line is an input-only signal that can receive a master timebase; the PCMCIA-CAN card cannot drive a timebase onto TRIG7\_CLK

Figure 3-7, *PCMCIA-CAN Synchronization Signal Interconnect Architecture for NI PCMCIA-CAN Hardware*, shows the PCMCIA-CAN synchronization signal interconnect architecture for NI PCMCIA-CAN hardware.

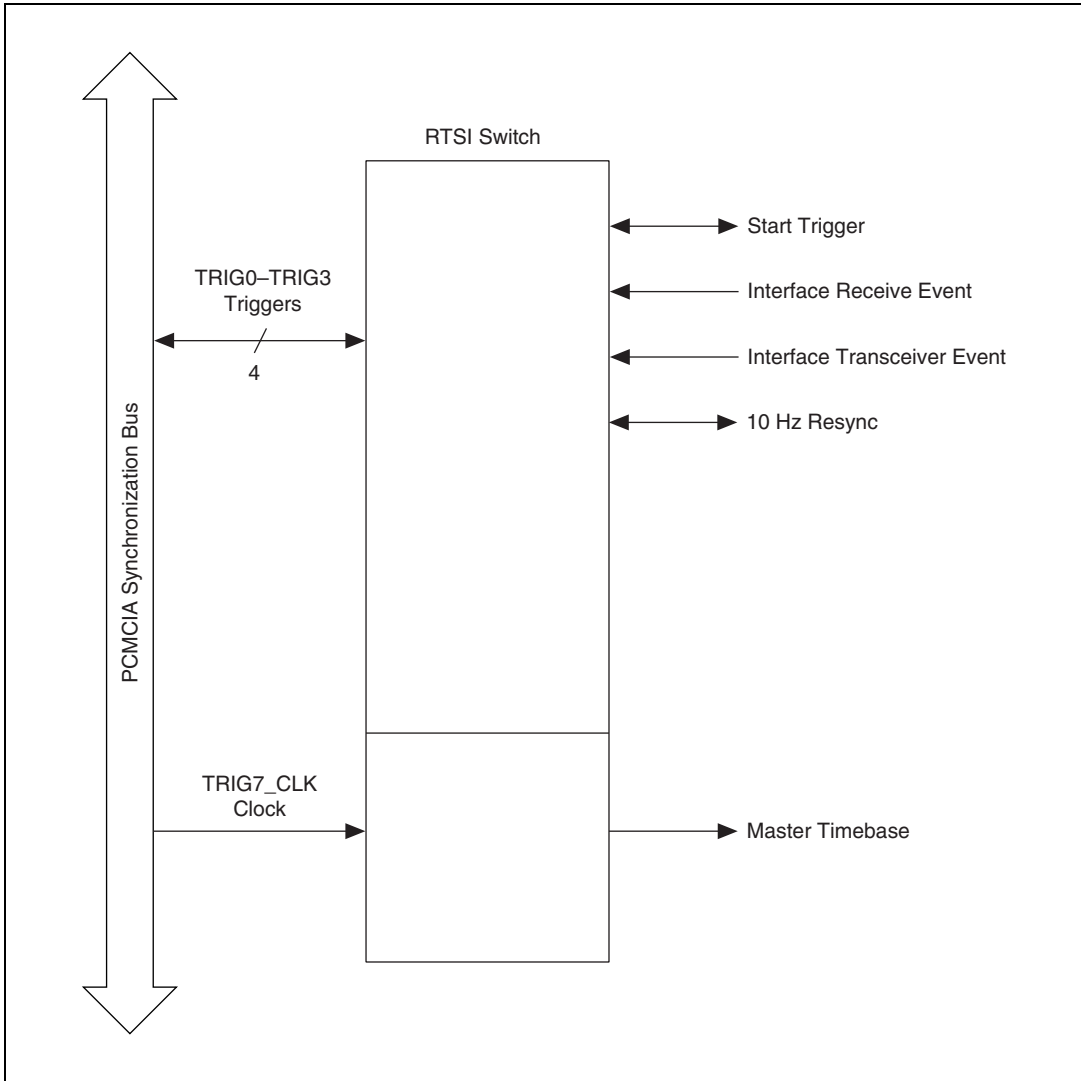

**Figure 3-7.** PCMCIA-CAN Synchronization Signal Interconnect Architecture for NI PCMCIA-CAN Hardware

Table 3-8, *PCMCIA-CAN Trigger Lines and Wire Colors*, shows the function of each trigger line and its corresponding wire color.

**Table 3-8.** PCMCIA-CAN Trigger Lines and Wire Colors

Signal	Function	Wire Color
TRIG_0 (RTSI0)	General I/O trigger	Red
TRIG_1 (RTSI1)	General I/O trigger	Orange
TRIG_2 (RTSI2)	General I/O trigger	Yellow
TRIG_3 (RTSI3)	General I/O trigger	Green
TRIG7_CLK (RTSI7/RTSI Clock)	Input-only timebase	White
GND	Ground	Black, brown, blue, purple, gray

To improve the signal integrity of the trigger lines, all GND wires should be connected to digital logic ground of the system. Unused trigger lines may also be grounded. Refer to Appendix E, *Specifications*, for detailed DC operating characteristics.

## USB-CAN

---

This section describes the hardware characteristics of the USB-CAN hardware.

### USB-8473/USB-8473s: High-Speed Physical Layer

The USB-CAN physical layer circuitry interfaces the CAN protocol controller to the physical bus wires. The USB-CAN High-Speed physical layer is powered internally from the USB through a DC-DC converter, and is optically isolated up to 500 V<sub>DC</sub> (withstand, 2s max) channel-to-bus. This isolation protects your NI-CAN hardware and the PC it is connected to from being damaged by high-voltage spikes on the CAN bus.

## Transceiver

USB-CAN High-Speed hardware uses the Philips TJA1041 High-Speed CAN transceiver. The TJA1041 is fully compatible with the ISO 11898 standard and supports baud rates up to 1 Mbps. This device also supports advanced power management through a low-power sleep mode. This feature is provided as the Transceiver Mode attribute of the Frame API. For detailed TJA1041 specifications, refer to the Philips TJA1041 data sheet.

## Bus Power Requirements

Because the High-Speed physical layer is completely internally powered through USB, there is no need to supply bus power. The V<sub>-</sub> signal serves as the reference ground for the isolated signals. Refer to the [High-Speed PCI, PXI, and USB Connector Pinout](#) section of Chapter 4, [Connectors and Cables](#), for information about how to connect signals to a High-Speed CAN interface.

## LED Indicators

Table 3-9 provides a description of the LEDs on the front panel of the USB-8473 and USB-8473s.

**Table 3-9.** LED Indicators for USB-8473/8473s Module

Name	Function
USB	Indicates connectivity to a USB Host. Green indicates a USB full speed connection. Amber indicates a USB high speed connection.
CAN	Flashes to indicate the presence of traffic on the CAN bus.

## USB-8472/USB-8472s: Low-Speed/Fault-Tolerant Physical Layer

The USB-CAN Low-Speed/Fault-Tolerant physical layer is powered internally from the USB through a DC-DC converter, and is optically isolated up to 500 V<sub>DC</sub> (withstand, 2s max) channel-to-bus. This isolation protects your NI CAN hardware and the PC it is connected to from being damaged by high-voltage spikes on the CAN bus.

### Transceiver

USB-CAN Low-Speed/Fault-Tolerant hardware uses the Philips TJA1054A Low-Speed CAN transceiver. The TJA1054A supports baud rates up to 125 kbps. The transceiver can detect and automatically recover from the following CAN bus failures:

- CAN\_H wire interrupted
- CAN\_L wire interrupted
- CAN\_H short-circuited to battery
- CAN\_L short-circuited to battery
- CAN\_H short-circuited to VCC
- CAN\_L short-circuited to VCC
- CAN\_H short-circuited to ground
- CAN\_L short-circuited to ground
- CAN\_H and CAN\_L mutually short-circuited

The TJA1054A supports advanced power management through a low-power sleep mode. This feature is provided as the Transceiver Mode attribute of the Frame API. For detailed specifications about the TJA1054A, refer to the Philips TJA1054 data sheet.

### Bus Power Requirements

Because the Low-Speed/Fault-Tolerant physical layer is completely powered internally through USB, there is no need to supply bus power. The V<sub>-</sub> signal serves as the reference ground for the isolated signals. Refer to the [Low-Speed/Fault-Tolerant PCI, PXI, and USB Connector Pinout](#) section of Chapter 4, [Connectors and Cables](#), for information about how to connect signals to a Low-Speed/Fault-Tolerant CAN interface.



## LED Indicators

Table 3-10 provides a description of the LEDs on the front panel of the USB-8472 and USB-8472s.

**Table 3-10.** LED Indicators for USB-8472/8472s Module

Name	Function
USB	Indicates connectivity to a USB Host. Green indicates a USB full speed connection. Amber indicates a USB high speed connection.
CAN	Flashes to indicate the presence of traffic on the CAN bus.

## USB-LIN

---

This section describes the USB-LIN hardware.

### USB-8476/USB-8476s: LIN

The USB-LIN physical layer circuitry interfaces the LIN microcontroller to the physical bus wires. The USB-LIN physical layer is powered externally from VBat (required for the LIN bus), and is optically isolated up to 500 V<sub>DC</sub> (withstand, 2s max) channel-to-bus. This isolation protects your NI-LIN hardware and the PC it is connected to from being damaged by high-voltage spikes on the LIN bus.

### Transceiver

USB-LIN hardware uses the Amtel ATA6625 LIN transceiver. The ATA6625 is fully compatible with the ISO-9141 standard and supports baud rates up to 20 kbps. This device also supports advanced power management through a low-power sleep mode. This feature is provided as the Transceiver Mode attribute of the Frame API. For detailed ATA6625 specifications, refer to the Amtel ATA6625 data sheet.

### Bus Power Requirements

The LIN physical layer is powered through the LIN bus VBat power. The USB-8476 physical layer requires a DC power supply with an output of +5 to +27 V (ATA6625) or +8 to +18 V (ATA6620), as specified in Table 3-11, *Bus Power Requirements for USB-8476*. You should take these requirements into account when determining the bus power supply

requirements for the system. The Gnd pin serves as the reference ground for the isolated signals. Refer to the *High-Speed PCI, PXI, and USB Connector Pinout* section of Chapter 4, *Connectors and Cables*, for information about how to connect signals to a LIN interface.

**Table 3-11.** Bus Power Requirements for USB-8476

Characteristic	Specification
Voltage	+5 to +27 VDC (ATA6625) or +8 to +18 VDC (ATA6620) on VBat connector pin (referenced to Gnd)
Current	55 mA maximum

## LED Indicators

Table 3-12 provides a description of the LEDs on the front panel of the USB-8476 and USB-8476s.

**Table 3-12.** LED Indicators for USB-8476/8476s Module

Name	Function
USB	Indicates connectivity to a USB Host. Green indicates a USB full speed connection. Amber indicates a USB high speed connection.
LIN	Flashes to indicate the presence of traffic on the LIN bus.
VBAT	Indicates the presence of LIN bus power.

## Synchronization in USB-CAN/LIN Devices

USB-847 $x$  with Sync series hardware give you the ability to synchronize multiple NI-USB-CAN/LIN devices with each other and with a variety of DAQ, IMAQ and Motion Products. Synchronization occurs through a 3-pin Combicon connection allowing for a shared timestamp clock, start trigger and ground. USB-847 $x$  with Sync series hardware can synchronize to timestamp clocks of 20 Mhz, 10 Mhz, or 1 Mhz. For 20 MHz synchronization, ensure that the synchronization cable is shielded and grounded. Clock frequency is detected automatically by the hardware and illegal clock frequencies will be reported as an error. USB-847 $x$  with Sync series hardware can also generate a clock of 1MHz, allowing for accurate CAN-CAN, CAN-LIN, and LIN-LIN synchronization.

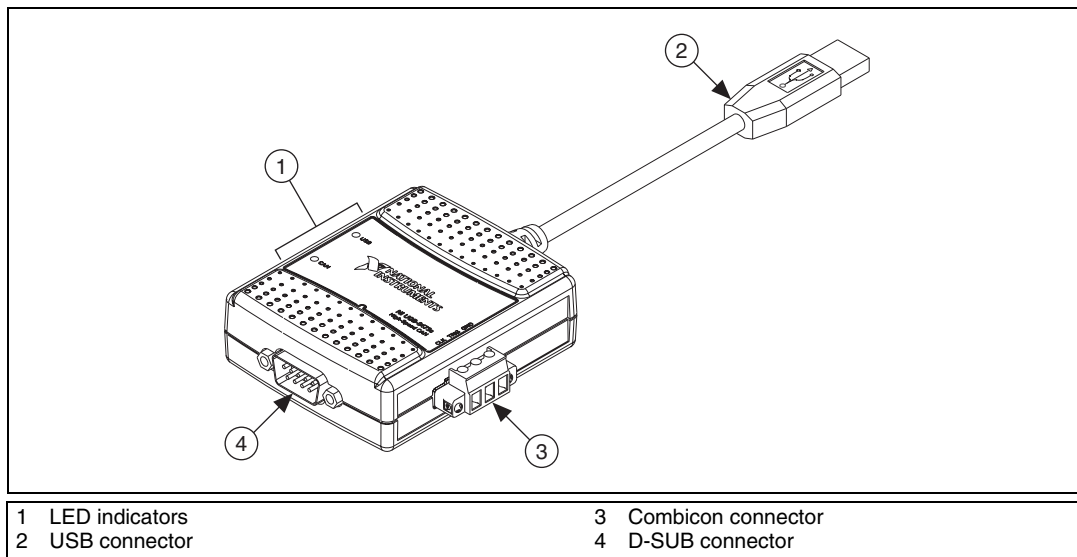

**Figure 3-8.** USB-CAN Connector Cable

**Table 3-13.** USB-CAN Combicon Connector Pinout

Pin	Description
CLK	Clock pin
TRG	Trigger pin
GND	Ground pin

For information on the pinout of the USB-CAN D-SUB connector, refer to the [High-Speed PCI, PXI, and USB Connector Pinout](#) section of Chapter 4, [Connectors and Cables](#).

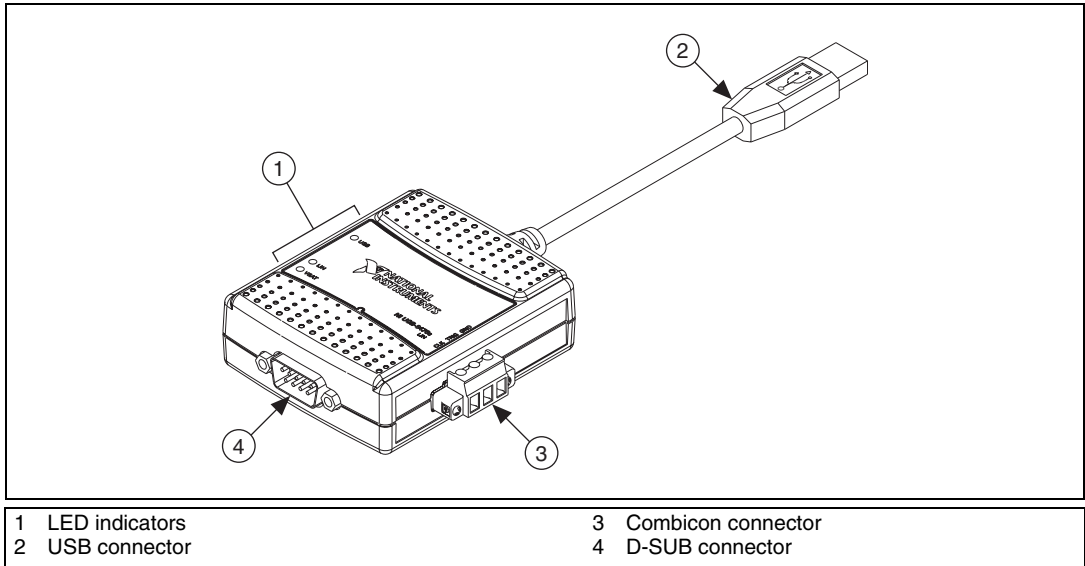

Figure 3-9. USB-LIN Connector Cable

Table 3-14. USB-LIN Combicon Connector Pinout

Pin	Description
CLK	Clock pin
TRG	Trigger pin
GND	Ground pin

For information on the pinout of the USB-LIN D-SUB connector, refer to the [USB-LIN Connector Pinout](#) section of Chapter 4, *Connectors and Cables*.

# CAN for CompactRIO

---

This section describes the use of CompactRIO with CAN.

## What is CompactRIO?

National Instruments CompactRIO is an advanced embedded control and acquisition system powered by NI reconfigurable I/O (RIO) technology. CompactRIO combines a low-power-consumption, real-time embedded processor with a high-performance RIO FPGA chipset. The RIO core has built-in data transfer mechanisms to pass data to the embedded processor for real-time analysis, post processing, data logging, or communication to a networked host computer. CompactRIO provides direct hardware access to the I/O circuitry of each I/O module using LabVIEW FPGA I/O functions. Each I/O module includes built-in connectivity, signal conditioning, conversion circuitry (such as ADC or DAC), and an optional isolation barrier.

## NI 985x

The NI 9853 is a CAN High-Speed I/O module for the CompactRIO platform. For information on the NI 9853 CAN module, refer to the *NI 9853 Operating Instructions*.

The NI 9852 is a CAN Low-Speed I/O module for the CompactRIO platform. For information on the NI 9852 CAN module, refer to the *NI 9852 Operating Instructions*.

For information on the software support for the NI 9853 and NI 9852 modules, refer to the LabVIEW FPGA help.

# Connectors and Cables

This chapter describes the input and output signal connections to the NI CAN hardware and the cabling requirements for interfacing to a CAN network. Cables should be constructed to meet these requirements, as well as the requirements of the other CAN devices in the network.

## High-Speed CAN Pinout Cable

This section describes the High-Speed CAN pinout cable.

### High-Speed PCI, PXI, and USB Connector Pinout

PCI-CAN, PXI-8461, USB-8473, and USB-8473s hardware have a 9-pin male D-SUB (DB9) connector for each port. The 9-pin D-SUB connector follows the pinout recommended by CiA DS 102. Figure 4-1 shows the 9-pin D-SUB connector pinout.

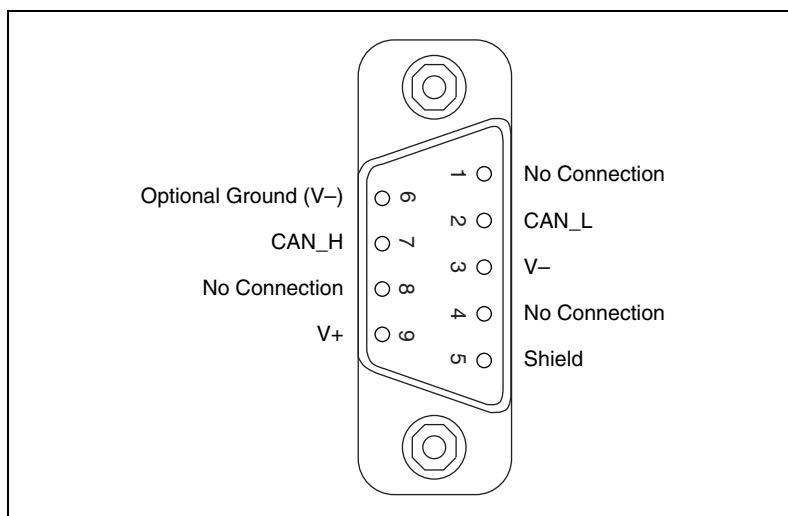

**Figure 4-1.** Pinout for 9-Pin D-SUB Connector

**Table 4-1.** Pinout for 9-Pin D-SUB Connector

D-SUB Pin	Signal	Description
1	No Connection	—
2	CAN_L	CAN_L bus line
3	V-	CAN reference ground
4	No Connection	—
5	(Shield)	Optional CAN shield
6	(V-)	Optional CAN reference ground
7	CAN_H	CAN_H bus line
8	No Connection	—
9	(V+)	Optional CAN power supply if bus power or external VBAT is required

CAN\_H and CAN\_L are signals lines that carry the data on the CAN network. These signals should be connected using twisted-pair cable.

V- serves as the reference ground for CAN\_H and CAN\_L.

V+ supplies bus power to the CAN physical layer if external power is required. All High-Speed Series 2 PCI, PXI, and USB hardware is powered internally, so it is not necessary to supply V+, unless you have configured the VBAT jumper for EXT.

Shield is an optional connection when using a shielded CAN cable. Connecting the optional CAN shield may improve signal integrity in a noisy environment.

## PCMCIA Connector Pinout

PCMCIA-CAN cables have both a 9-pin male D-SUB and Combicon-style pluggable screw terminal connector for each port. Figure 4-2, [PCMCIA-CAN Cable](#), shows the end of a PCMCIA-CAN cable. The arrow points to pin 1 of the 5-pin screw terminal block. All of the signals on the 5-pin screw terminal are connected directly to the corresponding pins on the 9-pin D-SUB.

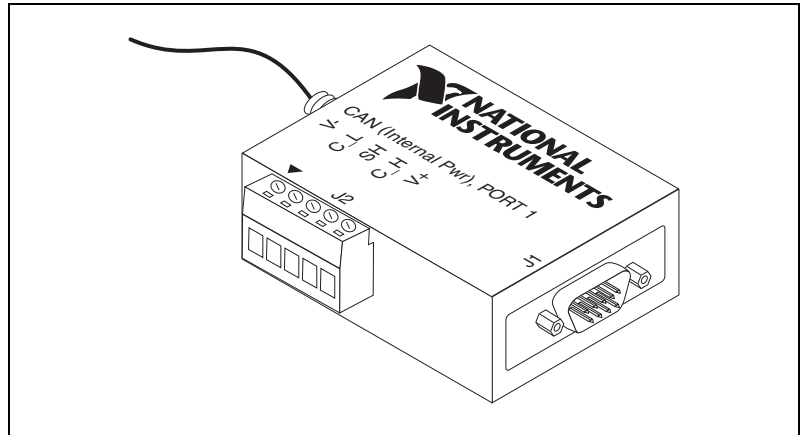

Figure 4-2. PCMCIA-CAN Cable

Table 4-2. PCMCIA-CAN Cable Connector Pin Descriptions

D-SUB Pin	Combicon Pin	Signal	Description
1	—	No Connection	—
2	2	CAN_L	CAN_L bus line
3	1	V-	CAN reference ground
4	—	No Connection	—
5	3	(Shield)	Optional CAN shield
6	—	(V-)	Optional CAN reference ground
7	4	CAN_H	CAN_H bus line
8	—	No Connection	—
9	5	No Connection	—

CAN\_H and CAN\_L are signal lines that carry the data on the CAN network. These signals should be connected using twisted-pair cable.

V- serves as the reference ground for CAN\_H and CAN\_L.

Shield is an optional connection when using a shielded CAN cable. Connecting the optional CAN shield may improve signal integrity in a noisy environment.



## Cabling Requirements for High-Speed CAN

Cables should meet the physical medium requirements specified in ISO 11898, shown in Table 4-3.

Belden cable (3084A) meets all of those requirements, and should be suitable for most applications.

**Table 4-3.** ISO 11898 Specifications for Characteristics of a CAN\_H and CAN\_L Pair of Wires

Characteristic	Value
Impedance	108 $\Omega$ minimum, 120 $\Omega$ nominal, 132 $\Omega$ maximum
Length-related resistance	70 m $\Omega$ /m nominal
Specific line delay	5 ns/m nominal

## Cable Lengths

The allowable cable length is affected by the characteristics of the cabling and the desired bit transmission rates. Detailed cable length recommendations can be found in the ISO 11898, CiA DS 102, and DeviceNet specifications.

ISO 11898 specifies 40 m total cable length with a maximum stub length of 0.3 m for a bit rate of 1 Mb/s. The ISO 11898 specification says that significantly longer cable lengths may be allowed at lower bit rates, but each node should be analyzed for signal integrity problems.

Table 4-4 lists the DeviceNet cable length specifications.

**Table 4-4.** DeviceNet Cable Length Specifications

Bit Rate	Thick Cable	Thin Cable
500 kb/s	100 m	100 m
250 kb/s	200 m	100 m
100 kb/s	500 m	100 m

## Number of Devices

The maximum number of devices depends on the electrical characteristics of the devices on the network. If all of the devices meet the requirements of ISO 11898, at least 30 devices may be connected to the bus. Higher numbers of devices may be connected if the electrical characteristics of the devices do not degrade signal quality below ISO 11898 signal level specifications. If all of the devices on the network meet the DeviceNet specifications, 64 devices may be connected to the network.

## Cable Termination

The pair of signal wires (CAN\_H and CAN\_L) constitutes a transmission line. If the transmission line is not terminated, each signal change on the line causes reflections that may cause communication failures.

Because communication flows both ways on the CAN bus, CAN requires that both ends of the cable be terminated. However, this requirement does not mean that every device should have a termination resistor. If multiple devices are placed along the cable, only the devices on the ends of the cable should have termination resistors. Refer to Figure 4-3 for an example of where termination resistors should be placed in a system with more than two devices.

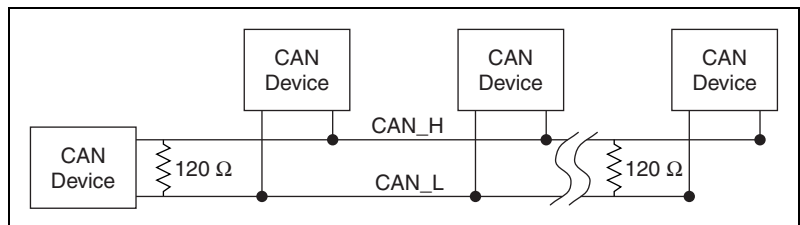
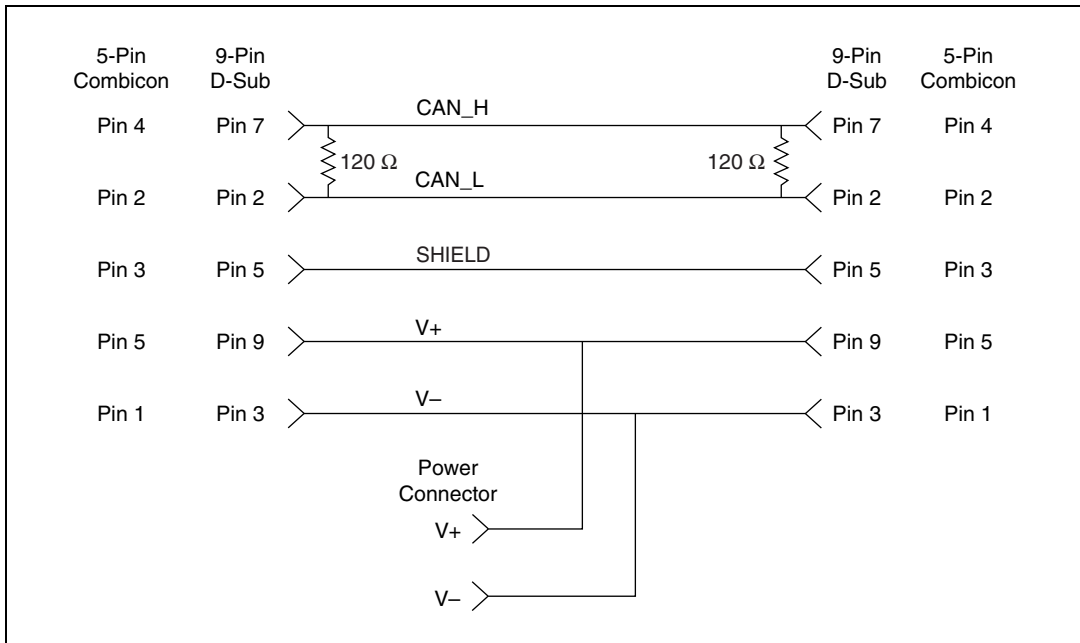

**Figure 4-3.** Termination Resistor Placement

The termination resistors on a cable should match the nominal impedance of the cable. ISO 11898 requires a cable with a nominal impedance of  $120\ \Omega$ , so a  $120\ \Omega$  resistor should be used at each end of the cable. Each termination resistor should be capable of dissipating 0.25 W of power.

## Cabling Example

Figure 4-4, *Cable Connecting Two CAN Devices*, shows an example of a cable to connect two CAN devices. For the internal power configuration, no V+ connection is required.



**Figure 4-4.** Cable Connecting Two CAN Devices

## Low-Speed/Fault-Tolerant CAN Pinout Cable

This section describes the Low-Speed/Fault-Tolerant CAN pinout cable.

### Low-Speed/Fault-Tolerant PCI, PXI, and USB Connector Pinout

PCI-CAN/LS, PXI-8460, USB-8472, and USB-8472s hardware have a 9-pin male D-SUB (DB9) connector for each port. The 9-pin D-SUB connector follows the pinout recommended by CiA DS 102. Figure 4-5, *Pinout for 9-Pin D-SUB Connector*, shows the 9-pin D-SUB connector pinout.

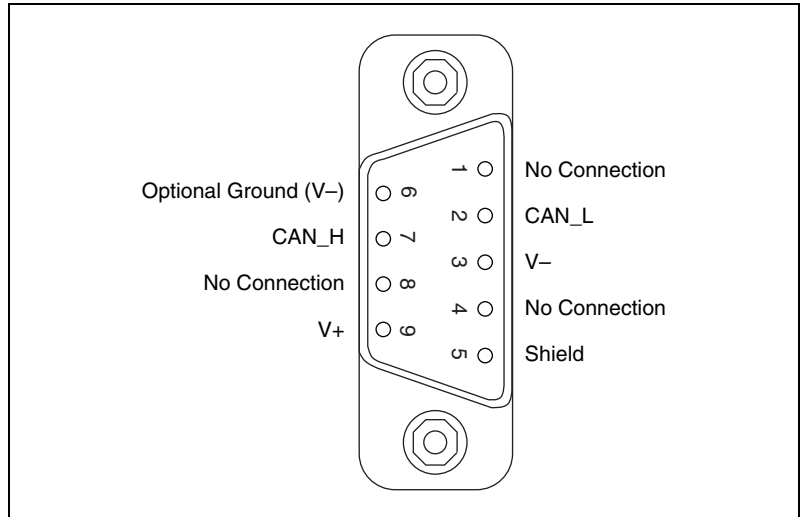

**Figure 4-5.** Pinout for 9-Pin D-SUB Connector

**Table 4-5.** 9-Pin D-SUB Connector Pin Descriptions

D-SUB Pin	Signal	Description
1	No Connection	—
2	CAN_L	CAN_L bus line
3	V-	CAN reference ground
4	No Connection	—
5	(Shield)	Optional CAN shield
6	(V-)	Optional CAN reference ground
7	CAN_H	CAN_H bus line
8	No Connection	—
9	(V+)	Optional CAN power supply if bus power or external VBAT is required



**Table 4-6.** PCMCIA-CAN/LS Cable Connector Pin Descriptions (Continued)

D-SUB Pin	Combicon Pin	Signal	Description
3	3	V-	CAN reference ground
4	—	No Connection	—
5	4	(Shield)	Optional CAN shield
6	—	(V-)	Optional CAN reference ground
7	6	CAN_H	CAN_H bus line
8	—	No Connection	—
9	5	No Connection	—

CAN\_H and CAN\_L are signal lines that carry the data on the CAN network. These signals should be connected using twisted-pair cable.

V- serves as the reference ground for CAN\_H and CAN\_L.

Shield is an optional connection when using a shielded CAN cable. Connecting the optional CAN shield may improve signal integrity in a noisy environment.

## Cabling Requirements for Low-Speed/Fault-Tolerant CAN

Cables should meet the physical medium requirements shown in Table 4-7.

**Table 4-7.** Specifications for Characteristics of a CAN\_H and CAN\_L Pair of Wires

Characteristic	Value
Length-related resistance	90 mΩ /m nominal
Length-related capacitance: CAN_L and ground, CAN_H and ground, CAN_L and CAN_H	30 pF/m nominal

Belden cable (3084A) meets all of those requirements, and should be suitable for most applications.

## Number of Devices

The maximum number of devices depends on the electrical characteristics of the devices on the network. If all of the devices meet the requirements of typical Low-Speed/Fault-Tolerant CAN, up to 32 devices may be connected to the bus. Higher numbers of devices may be connected if the electrical characteristics of the devices do not degrade signal quality below Low-Speed/Fault-Tolerant signal level specifications.

## Termination

Every device on the low-speed CAN network requires a termination resistor for each CAN data line: R<sub>RTH</sub> for CAN<sub>H</sub> and R<sub>RTL</sub> for CAN<sub>L</sub>. Figure 4-7 shows termination resistor placement in a low-speed CAN network.

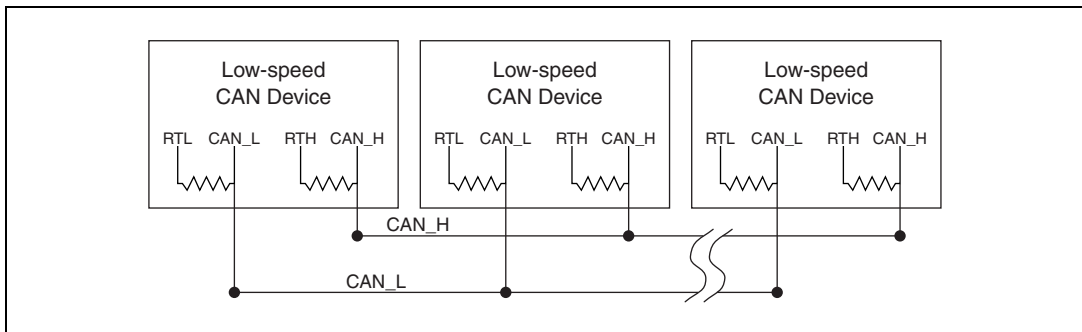

**Figure 4-7.** Termination Resistor Placement for Low-Speed CAN

The following sections explain how to determine the correct resistor values for the low-speed CAN card, and how to replace those resistors, if necessary.

For USB CAN (847x) interfaces, the termination is software selectable. Refer to the **Termination** attribute in [ncSetAttr.vi](#) of Chapter 10, *Frame API for LabVIEW*, for more details.

## Determining the Necessary Termination Resistance for the Board

Unlike High-Speed CAN, low-speed CAN requires termination at the low-speed CAN transceiver instead of on the cable. The termination requires two resistors: R<sub>RTH</sub> for CAN<sub>H</sub> and R<sub>RTL</sub> for CAN<sub>L</sub>. This configuration allows the Philips fault-tolerant CAN transceiver to detect and recover from bus faults. You can use the PCI-CAN/LS, PXI-8460, or

PCMCIA-CAN/LS to connect to a low-speed CAN network having from two to 32 nodes as specified by Philips (including the port on the NI CAN Low-Speed/Fault-Tolerant interface). You also can use the Low-Speed/Fault-Tolerant interface to communicate with individual low-speed CAN devices. It is important to determine the overall termination of the existing network, or the termination of the individual device, before connecting it to a Low-Speed/Fault-Tolerant port. Philips recommends an overall RTH and RTL termination of 100  $\Omega$  to 500  $\Omega$  (each) for a properly terminated low-speed network. The overall network termination may be determined as follows:

$$\frac{1}{R_{RTHoverall}} = \frac{1}{R_{RTHnode1}} + \frac{1}{R_{RTHnode2}} + \frac{1}{R_{RTHnode3}} + \frac{1}{R_{RTHnoden}}$$

Philips also recommends an individual device RTH and RTL termination of 500 to 16 k $\Omega$ . The PCI-CAN/LS or PXI-8460 card ships with termination resistor values of 510  $\Omega \pm 5\%$  per port mounted on the PCB. The PCI-CAN/LS or PXI-8460 kit also includes a pair of 15 k $\Omega \pm 5\%$  resistors for each port. After determining the termination of the existing network or device, you can use the following formula to indicate which value should be placed on the PCI-CAN/LS or PXI-8460 card in order to produce the proper overall RTH and RTL termination of 100 to 500  $\Omega$  upon connection of the card:

$$R_{RTHoverall} = \frac{1}{\left( \frac{1}{R_{RTHoveralloflow-speedCANinterface}} + \frac{1}{R_{RTHofexistingnetworkordevice}} \right)}$$

where

$R_{RTH overall}$  should be between 100 and 500  $\Omega$

$R_{RTH}$  of low-speed CAN interface = 510  $\Omega \pm 5\%$  (mounted) or  
15 k $\Omega \pm 5\%$  (in kit)

$R_{RTH} = R_{RTL}$

As the formula indicates, the 510  $\Omega \pm 5\%$  shipped on the card will work with properly terminated networks having a total RTH and RTL termination of 125 to 500  $\Omega$ , or individual devices having an RTH and RTL termination of 500 to 16 k $\Omega$ . For communication with a network having an overall RTH and RTL termination of 100  $\Omega$  to 125  $\Omega$ , you will need to replace the 510  $\Omega$  resistors with the 15 k $\Omega$  resistors in the kit. Refer to the next section of this chapter, [Replacing the Termination Resistors on the PCMCIA-CAN/LS Cable](#). The PCMCIA-CAN/LS cable ships with



screw-terminal mounted RTH and RTL values of  $510\ \Omega \pm 5\%$  per port. The PCMCIA-CAN/LS cable also internally mounts a pair of  $15.8\ \text{k}\Omega \pm 1\%$  resistors in parallel with the external  $510\ \Omega$  resistors for each port. This produces an effective RTH and RTL of  $494\ \Omega$  per port for the PCMCIA-CAN/LS cable. After determining the termination of the existing network or device, you can use the formula below to indicate which configuration should be used on the PCMCIA-CAN/LS cable to produce the proper overall RTH and RTL termination of 100 to  $500\ \Omega$  upon connection of the cable:

$$R_{RTH\text{overall}} = \frac{1}{\left( \frac{1}{R_{RTH\text{oflow-speedCANinterface}}} + \frac{1}{R_{RTH\text{ofexistingnetworkordevice}}} \right)}$$

where

$R_{RTH\text{ overall}}$  should be between  $100\ \Omega$  and  $500\ \Omega$

$R_{RTH}$  of PCMCIA-CAN/LS =  $494\ \Omega$  ( $510\ \Omega \pm 5\%$  (external) in parallel with  $15.8\ \text{k}\Omega \pm 1\%$  (internal), or  $15.8\ \text{k}\Omega \pm 1\%$  (internal) only

$|R_{RTH} = R_{RTL}$

As the formula indicates, the  $510\ \Omega \pm 5\%$  in parallel with  $15.8\ \text{k}\Omega \pm 1\%$  shipped on the cable will work with properly terminated networks having a total RTH and RTL termination of  $125\ \Omega$  to  $500\ \Omega$ , or individual devices having an RTH and RTL termination of  $500\ \Omega$  to  $16\ \text{k}\Omega$ . For communication with a network having an overall RTH and RTL termination of  $100\ \Omega$  to  $125\ \Omega$ , you will need to disconnect the  $510\ \Omega$  resistors from the 7-pin pluggable screw terminal. This will make the RTH and RTL values of the PCMCIA-CAN/LS cable equal to the internal resistance of  $15.8\ \text{k}\Omega \pm 1\%$ . To produce RTH and RTL values between  $494$  and  $15.8\ \text{k}\Omega$  on the PCMCIA-CAN/LS cable, use the following formula:

$$R_{RTH\text{overall}} = \frac{1}{\left( \frac{1}{R_{RTH\text{ofPCMCIA-CANLS}}} + \frac{1}{R_{RTH\text{ofexistingnetworkordevice}}} \right)}$$

where

$R_{Internal\ R_{TH}}$  of PCMCIA-CAN/LS =  $15.8\ \text{k}\Omega \pm 1\%$

$|R_{RTH} = R_{RTL}$

For information on replacing the external RTH and RTL resistors on the PCMCIA-CAN/LS cable, refer to the [Replacing the Termination Resistors on the PCMCIA-CAN/LS Cable](#) section of this chapter.

## Software Selectable Termination (USB-8472s only)

The USB-8472 and USB-8472s feature a software selectable bus termination resistors, allowing the user to adjust the overall network termination through an API call. In general, if the existing network has an overall network termination of 125  $\Omega$  or less, you should select the 5 K $\Omega$  option. For existing overall network termination above 125  $\Omega$ , you should select the 1 K $\Omega$  termination option.

## Replacing the Termination Resistors on Your PCI-CAN/LS Board

Complete these steps to replace the termination resistors on the PCI-CAN/LS card, after you have determined the correct value in the [Determining the Necessary Termination Resistance for the Board](#) section of this chapter.

1. Remove the termination resistors on the low-speed CAN card. Figure 4-8, [Location of Termination Resistors on PCI-CAN/LS2 Card](#), shows the location of the termination resistor sockets on a PCI-CAN/LS2 card.

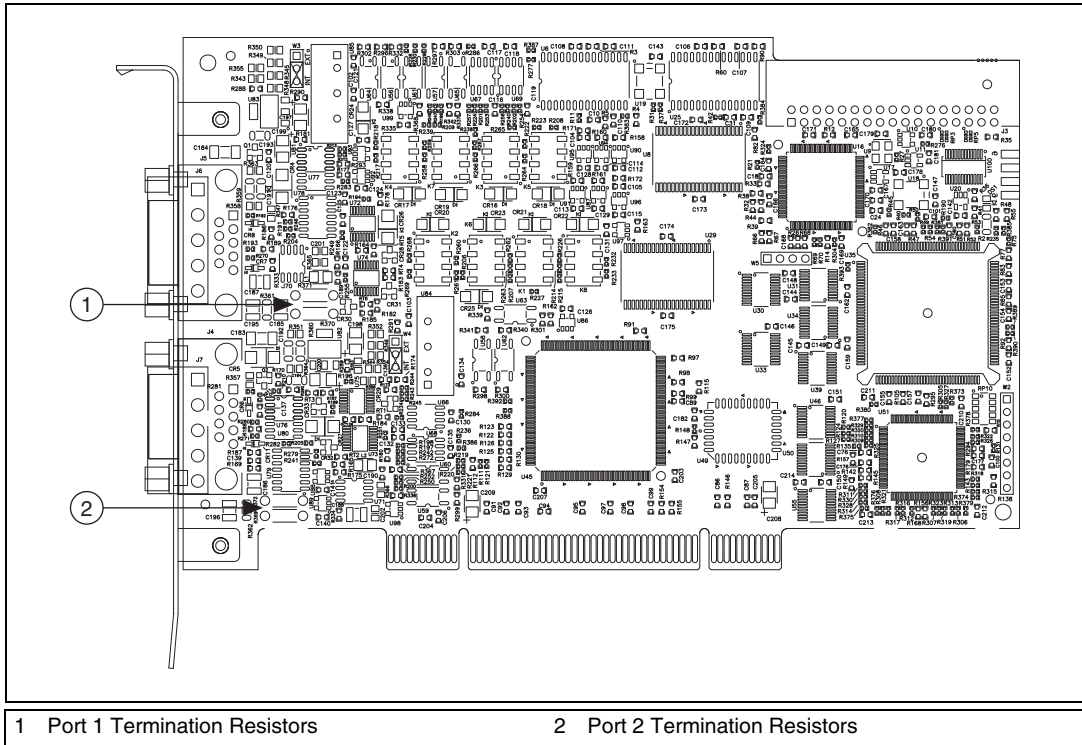

**Figure 4-8.** Location of Termination Resistors on PCI-CAN/LS2 Card

2. Cut and bend the lead wires of the resistors you want to install. Refer to Figure 4-9.

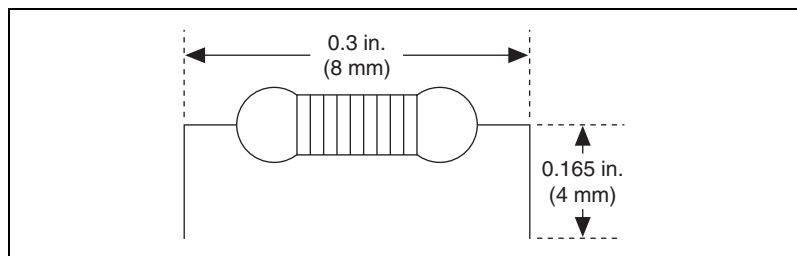

**Figure 4-9.** Preparing Lead Wires of Replacement Resistors

3. Insert the replacement resistors into the empty sockets.
4. Refer to the *NI-CAN Software and Hardware Installation Guide* in the jewel case of the program CD to complete the hardware installation.

## Replacing the Termination Resistors on the PXI-8460 Board

Complete these steps to replace the termination resistors, after you have determined the correct value in the [Determining the Necessary Termination Resistance for the Board](#) section of this chapter.

1. Remove the termination resistors on the PXI-8460. Figure 4-10 shows the location of the termination resistor sockets on a PXI-8460.

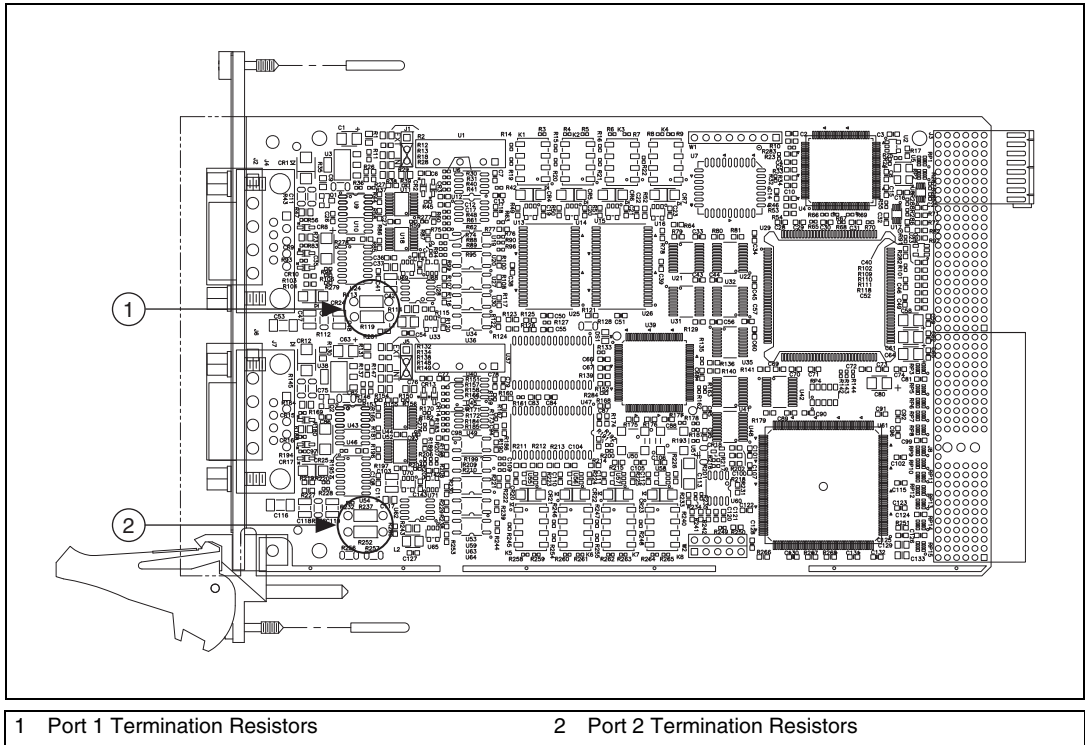
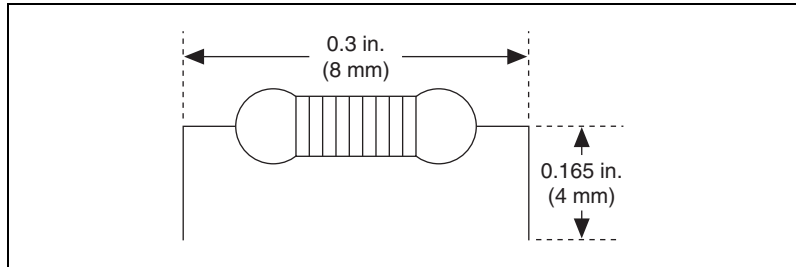

Figure 4-10. Location of Termination Resistors on a PXI-8460

- Cut and bend the lead wires of the resistors you want to install. Refer to Figure 4-11 for an example.



**Figure 4-11.** Preparing Lead Wires of Replacement Resistors

- Insert the replacement resistors into the empty sockets.
- Refer to the *NI-CAN Software and Hardware Installation Guide* in the jewel case of the program CD to complete the hardware installation.

## Replacing the Termination Resistors on the PCMCIA-CAN/LS Cable

Complete these steps to replace the termination resistors on the PCMCIA-CAN/LS cable after you have determined the correct value in the [Determining the Necessary Termination Resistance for the Board](#) section of this chapter.

- Remove the two termination resistors on the PCMCIA-CAN/LS cable by loosening the pluggable terminal block mounting screws for pins 1 and 2 (RTL) and pins 6 and 7 (RTH).
- Bend and cut the lead wires of the two resistors you want to install, as shown in Figure 4-12.

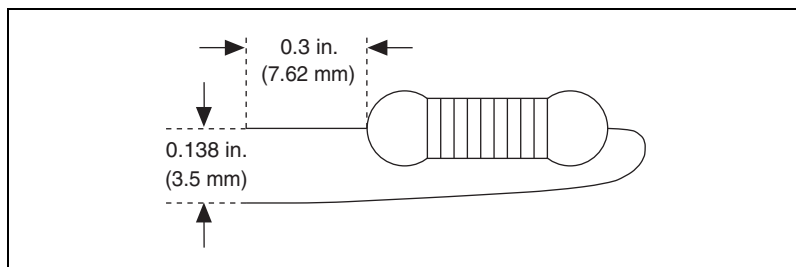

**Figure 4-12.** Preparing Lead Wires of PCMCIA-CAN/LS Cable Replacement Resistors

- Mount RTL by inserting the leads of one resistor into pins 1 and 2 of the pluggable terminal block and tightening the mounting screws.

- Mount RTH by inserting the leads of the second resistor into pins 6 and 7 of the pluggable terminal block and tightening the mounting screws.
4. Refer to the *NI-CAN Software and Hardware Installation Guide* in the jewel case of the program CD to complete the hardware installation.

## Cabling Example

Figure 4-13 shows an example of a cable to connect two low-speed CAN devices. For the PCMCIA-CAN/LS cables, only V-, CAN\_L, and CAN\_H are required to be connected to the bus.

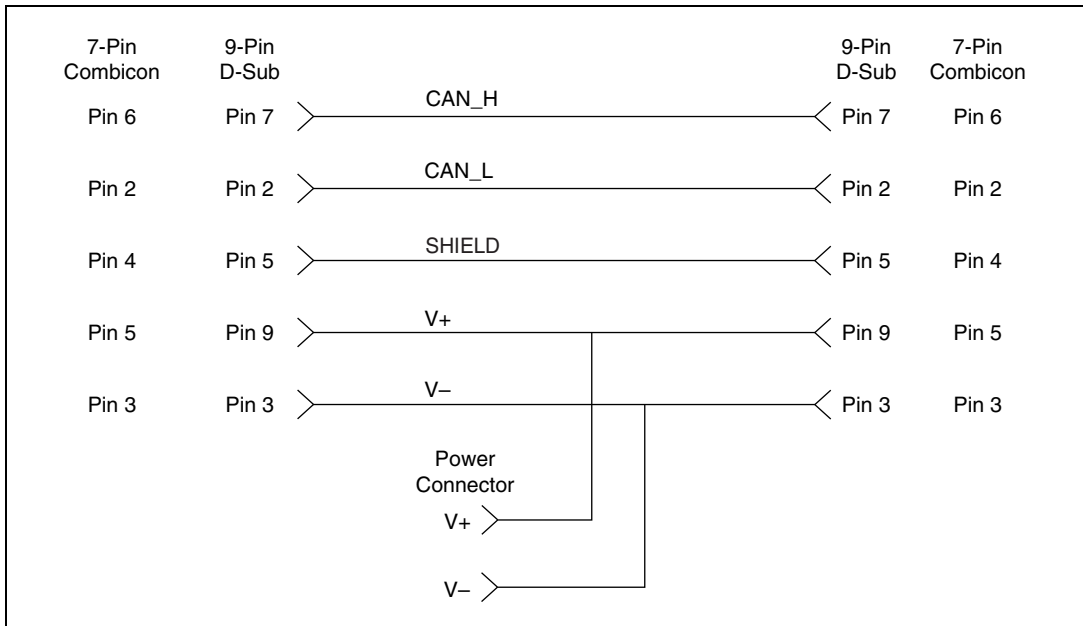

Figure 4-13. Cabling Example

## Single Wire CAN Pinout Cable

This section describes the Single Wire CAN pinout cable.

### Single Wire PCI and PXI Connector Pinout

PCI-CAN/XS and PXI-8464 hardware have a 9-pin male D-SUB (DB9) connector for each port. The 9-pin D-SUB connector follows the pinout recommended by CiA DS 102. Figure 4-14, [Pinout for 9-Pin D-SUB Connector](#), shows the 9-pin D-SUB connector pinout.

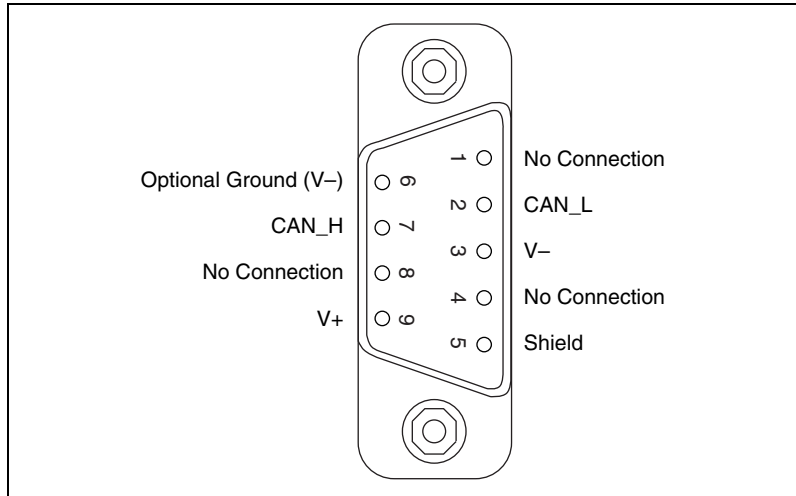

**Figure 4-14.** Pinout for 9-Pin D-SUB Connector

**Table 4-8.** 9-Pin D-SUB Connector Pin Descriptions

D-SUB Pin	Signal	Description
1	No Connection	—
2	CAN_L	CAN_L bus line
3	V-	CAN reference ground
4	No Connection	—
5	(Shield)	Optional CAN shield
6	(V-)	Optional CAN reference ground
7	CAN_H	CAN_H bus line
8	No Connection	—
9	(V+)	Optional CAN power supply if bus power or external VBAT is required

CAN\_H and CAN\_L are signals lines that carry the data on the CAN network. These signals should be connected using twisted-pair cable.

V- serves as the reference ground for CAN\_H and CAN\_L.

V+ supplies bus power to the CAN physical layer if external power is required. All Low-Speed/Fault-Tolerant Series 2 PCI and PXI hardware is powered internally, so it is not necessary to supply V+ unless you have configured the VBAT jumper for EXT.

Shield is an optional connection when using a shielded CAN cable. Connecting the optional CAN shield may improve signal integrity in a noisy environment.

## PCMCIA-CAN Connector Pinout

PCMCIA-CAN cables have both a 9-pin male D-SUB and Combicon-style pluggable screw terminal connector for each port. Figure 4-15 shows the end of a PCMCIA-CAN cable. The arrow points to pin 1 of the 5-pin screw terminal block. All of the signals on the 5-pin screw terminal are connected directly to the corresponding pins on the 9-pin D-SUB.

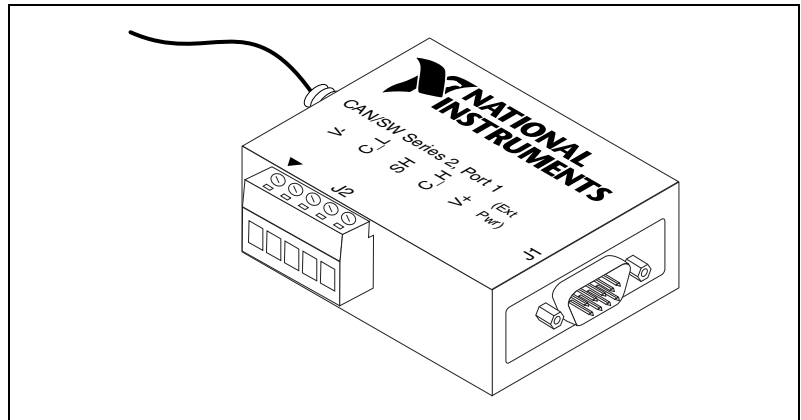

Figure 4-15. PCMCIA-CAN Cable

Table 4-9. PCMCIA-CAN Cable Connector Pin Descriptions

D-SUB Pin	Combicon Pin	Signal	Description
1	—	No Connection	—
2	2	No Connection	—
3	1	V-	CAN reference ground
4	—	No Connection	—
5	3	(Shield)	Optional CAN shield



**Table 4-9.** PCMCIA-CAN Cable Connector Pin Descriptions (Continued)

D-SUB Pin	Combicon Pin	Signal	Description
6	—	(V-)	Optional CAN reference ground
7	4	CAN_H	CAN_H bus line
8	—	No Connection	—
9	5	(V+)	CAN power supply

CAN\_H is the signal line that carries the data on the CAN network.

V- serves as the reference ground for CAN\_H.

V+ supplies bus power to the Single Wire CAN transceiver.

Shield is an optional connection when using a shielded CAN cable. Connecting the optional CAN shield may improve signal integrity in a noisy environment.

## Cabling Requirements for Single Wire CAN

The number of nodes on the network, the total cable length of the system, the bus loading of each node, and the clock tolerance are all interrelated. It is therefore the responsibility of the system designer to factor in all of the above parameters when designing a Single Wire CAN network. The SAE J2411 standard provides some recommended specifications that can help in making these decisions:

### Cable Length

There shall be no more than 60 m between any two network system ECU nodes.

### Number of Devices

As stated previously, the maximum number of Single Wire CAN nodes allowed on the network depends on the electrical characteristics of the devices and cable. If all of the devices and cables meet the requirements of J2411, between 2 and 32 devices may be networked together.

### Termination (Bus Loading)

NI Single Wire CAN hardware includes a built-in 9.09 k $\Omega$  load resistor as specified by J2411.

## Cabling Example

Figure 4-16 shows an example of a cable to connect two Single Wire CAN devices.

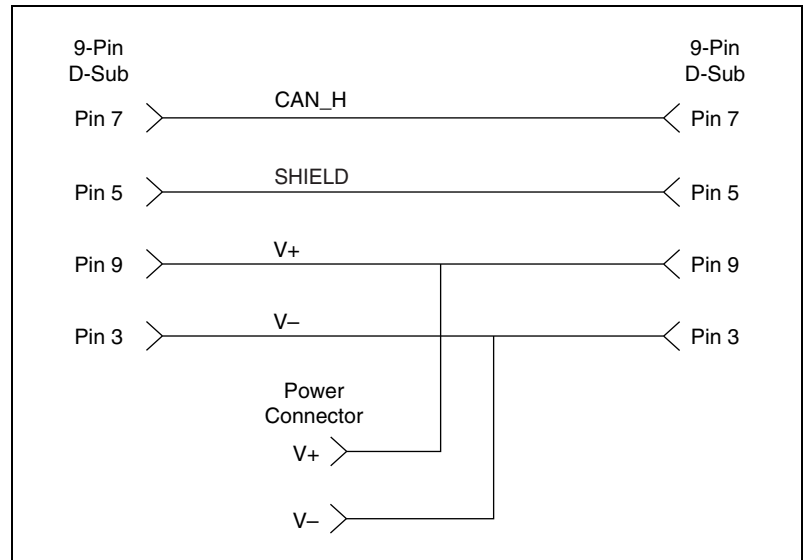

Figure 4-16. Cabling Example

## XS CAN Pinout Cable

This section describes the XS CAN pinout cable.

### XS PCI and PXI Connector Pinout

PCI-CAN/XS and PXI-8464 hardware have a 9-pin male D-SUB (DB9) connector for each port.

When an XS port is selected as **High-Speed**, its connector pinout is identical to a dedicated High-Speed interface as described in the [High-Speed PCI, PXI, and USB Connector Pinout](#) section of this chapter.

When an XS port is selected as **Low-Speed/Fault-Tolerant**, its connector pinout is identical to a dedicated Low-Speed/Fault-Tolerant interface as described in the [Low-Speed/Fault-Tolerant PCI, PXI, and USB Connector Pinout](#) section of this chapter.

When an XS port is selected as **Single Wire**, its connector pinout is identical to a dedicated Single Wire interface as described in the [Single Wire PCI and PXI Connector Pinout](#) section of this chapter.

When an XS port has been selected as **External**, a different set of signals is routed to the 9-pin D-SUB connector. Figure 4-17 shows the 9-pin D-SUB connector pinout for an XS port in **External** mode.

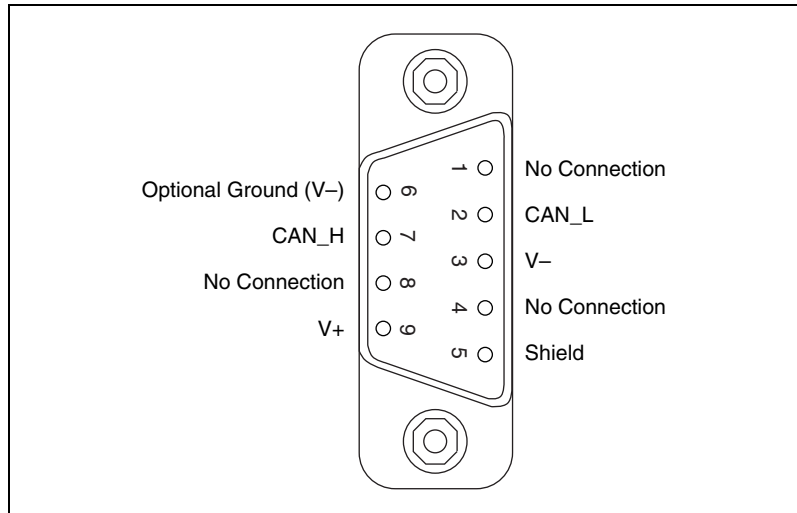

**Figure 4-17.** Pinout for 9-Pin D-SUB Connector

**Table 4-10.** 9-Pin D-SUB Connector Pin Descriptions

D-SUB Pin	Signal	Description
1	MODE0	Digital output signal for external transceiver mode control (XS port in external mode only)
2	RX	RX0 pin from SJA1000 CAN controller (XS port in external mode only)
3	GND	Ground
4	MODE1	Digital output signal for external transceiver mode control (XS port in external mode only)
5	No Connection	Do not connect signals to this pin
6	(GND)	Optional ground
7	TX	TX0 pin from SJA1000 CAN controller (XS port in external mode only)

**Table 4-10.** 9-Pin D-SUB Connector Pin Descriptions (Continued)

<b>D-SUB Pin</b>	<b>Signal</b>	<b>Description</b>
8	STATUS	Digital input signal for external transceiver error reporting (XS port in external mode only)
9	No Connection	Do not connect signals to this pin

RX and TX are the serial receive and transmit signals from the SJA1000 CAN controller. GND serves as the reference ground for RX and TX.

MODE0 and MODE1 are digital output signals for controlling the mode selection of an external transceiver. For example, the TJA1041 and TJA1054A have STB and EN input pins to select the transceiver operating mode.

STATUS is a digital input signal for monitoring the status of an external transceiver. For example, the TJA1041 and TJA1054A have an ERR output to report bus fault conditions.

## Cabling Requirements for XS CAN

For cabling requirements information, refer to the appropriate section on cabling requirements for High-Speed, Low-Speed/Fault-Tolerant, or Single Wire CAN depending on the XS port mode. Note that due to the different cabling requirements for each physical layer, when switching an XS port, you may also need to change out the cable to meet the network cabling requirements.

When designing external transceiver circuits for an XS port in external mode, keep the signal connections between the 9-pin D-SUB connector and the transceiver circuit as short as possible. Ideally, the external transceiver circuit should mount directly to the 9-pin D-SUB connector if possible.

## External Transceiver Example

Figure 4-18 shows an example of an external transceiver circuit for an XS port in External mode.

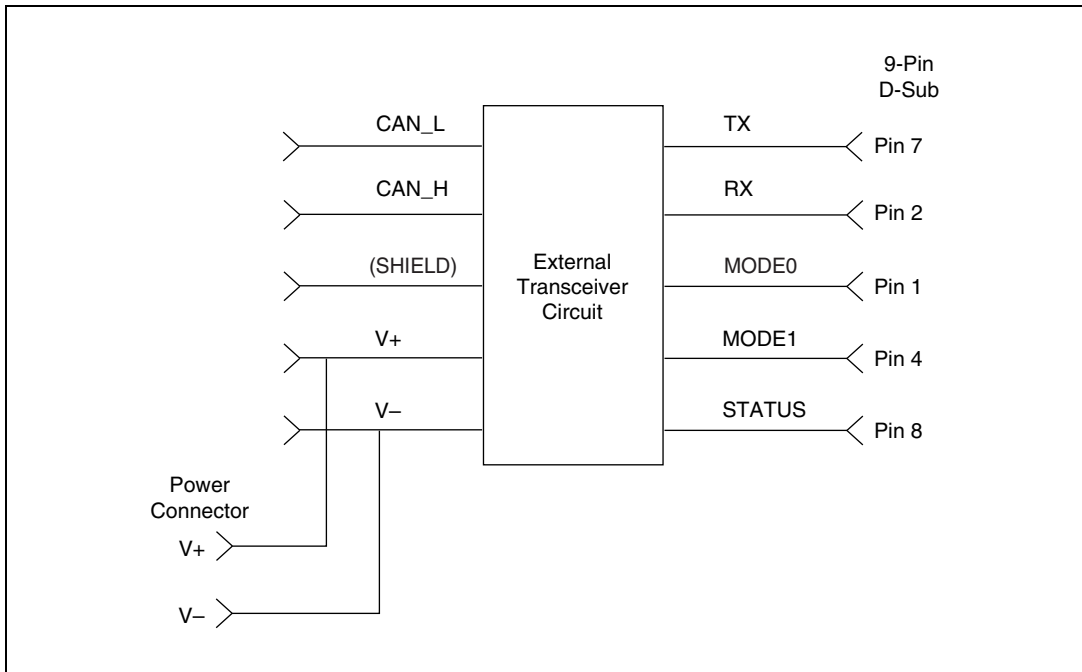

**Figure 4-18.** External Transceiver Circuit for an XS Port in External Mode

## LIN

This section describes the USB-LIN hardware.

### USB-LIN Connector Pinout

USB-8476 and USB-8476s hardware has a 9-pin male D-Sub (DB9) connector for connection to the LIN bus. Figure 4-19, [Pinout for 9-Pin D-SUB Connector](#), shows the 9-pin D-Sub connector pinout.

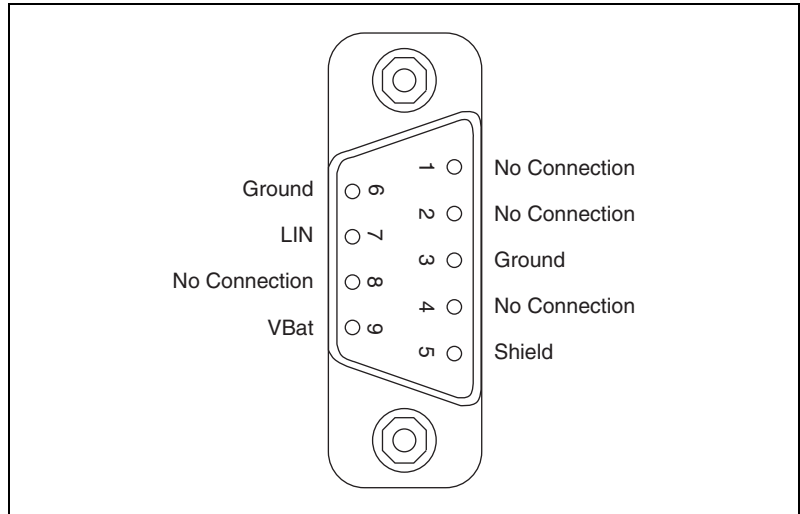

**Figure 4-19.** Pinout for 9-Pin D-SUB Connector

**Table 4-11.** 9-Pin D-SUB Connector Pin Descriptions

D-SUB Pin	Signal	Description
1	No Connection	—
2	No Connection	—
3	Ground	LIN reference ground.
4	No Connection	—
5	(Shield)	Optional LIN shield. Connecting the optional LIN shield may improve signal integrity in a noisy environment.
6	Ground	LIN reference ground.
7	LIN	Signal line that carries the data on the LIN.

**Table 4-11.** 9-Pin D-SUB Connector Pin Descriptions (Continued)

D-SUB Pin	Signal	Description
8	No Connection	—
9	VBat	Supplies bus power to the LIN physical layer, as required by the LIN spec. All USB-LIN interfaces require bus power of 8–18 VDC.

## Cabling Requirements for LIN Specifications (LIN)

This section describes cabling requirements for LIN.

### Cable Specifications

LIN cables should meet the physical medium requirement of a bus RC time constant of 5 microseconds. For detailed formulas for calculating this value, refer to the *Line Characteristics* section of the LIN specification.

Belden cable (3084A) and other unterminated CAN/Serial quality cables meet these requirements, and should be suitable for most applications.

### Cable Lengths

The maximum allowable cable length is 40 meters, per the LIN specification.

### Number of Devices

The maximum number of devices on a LIN bus is 16, per the LIN specification.

### Termination

LIN cables require no termination, as nodes are terminated at the transceiver. Slave nodes are typically pulled up from the LIN bus to VBat with a 30 K $\Omega$  resistance and a serial diode. This termination is usually integrated into the transceiver package. The master node requires a 1 K $\Omega$  resistor and serial diode between the LIN bus and VBat.

On NI USB-LIN products, master termination is software selectable and can be enabled with the **Termination** attribute. For more information refer to the **ncSetAttribute** function within the Frame API.

---

# Application Development

This chapter explains how to develop an application using the NI-CAN APIs.

## Choose the Programming Language

---

The programming language you use for application development determines how to access the NI-CAN APIs.

### LabVIEW

NI-CAN functions and controls are available in the LabVIEW palettes. In LabVIEW 7.0 or later, the NI-CAN palette is located within the top-level **NI Measurements** palette. In earlier LabVIEW versions, the NI-CAN palette is located at the top-level. The top level of the NI-CAN function palette contains subpalettes for the Channel API and Frame API. Each subpalette of an API contains the most commonly used functions, with subpalettes for advanced functions.

The reference for each NI-CAN Channel API function is in Chapter 7, [Channel API for LabVIEW](#). The reference for each NI-CAN Frame API function is in Chapter 10, [Channel API for LabVIEW](#). To access the reference for a function from within LabVIEW, press <Ctrl-H> to open the help window, click on the NI-CAN function, and then follow the link.

The NI-CAN software includes a full set of examples for LabVIEW. These examples teach basic NI-CAN programming as well as advanced topics. The example help describes each example and includes a link you can use to open the VI.

The NI-CAN example help is in **Help»Find Examples»Hardware Input and Output»CAN**.



## LabWindows/CVI

Within LabWindows™/CVI™, the NI-CAN function panel is in **Libraries» NI-CAN**. Like other LabWindows/CVI function panels, the NI-CAN function panel provides help for each function and the ability to generate code.

The reference for each NI-CAN Channel API function is in Chapter 8, *Channel API for C*. The reference for each NI-CAN Frame API function is in Chapter 11, *Frame API for C*. You can access the reference for each function directly from within the function panel.

The header file for both NI-CAN APIs is `nican.h`. The library for both NI-CAN APIs is `nican.lib`.

The NI-CAN software includes a full set of examples for LabWindows/CVI. The NI-CAN examples are installed in the LabWindows/CVI directory under `samples\nican`.

Each example provides a complete LabWindows/CVI project (`.prj` file). A description of each example is provided in comments at the top of the `.c` file.

## Visual C++ 6

The NI-CAN software supports Microsoft Visual C/C++ version 6.

The `NIEXTCCOMPILERSUPP` environment variable is provided as an alias to the C language header file and library location. You can use this variable when compiling and linking an application.

To use either NI-CAN API, include the `nican.h` header file in the code, then link with the `nicanmsc.lib` library file.

For C applications (files with `.c` extension), include the header file by adding a `#include` to the beginning of the code, such as:

```
#include "nican.h"
```

The reference for each NI-CAN Channel API function is in Chapter 8, *Channel API for C*. The reference for each NI-CAN Frame API function is in Chapter 11, *Frame API for C*.

For linking applications, you must add the `nicanmsc.lib` file and the following statement to your linker project options to search for the library:

```
/libpath: "%(NIEXTCCOMPILERSUPP)\lib32\msvc"
```

You can find examples for the C language in the MS Visual C subfolder of the `\Users\Public\Documents\National Instruments\NI-CAN\Examples` directory on Windows Vista and the `\Documents and Settings\All Users\Shared Documents\National Instruments\NI-CAN\Examples` directory on Windows XP. Each example is in a separate folder. A description of each example is in comments at the top of the `.c` file.

## Borland C/C++

The `NIEXTCCOMPILERSUPP` environment variable is provided as an alias to the C language header file and library location. You can use this variable when compiling and linking an application.

To use either NI-CAN API, include the `nican.h` header file in the code, then link with the `nicanbor.lib` library file.

For C applications (files with `.c` extension), include the header file by adding a `#include` to the beginning of the code, such as:

```
#include "nican.h"
```

The reference for each NI-CAN Channel API function is in Chapter 8, *Channel API for C*. The reference for each NI-CAN Frame API function is in Chapter 11, *Frame API for C*.

For linking applications, you must add the `nicanbor.lib` file and the following statement to your linker project options to search for the library:

```
/libpath:"$(NIEXTCCOMPILERSUPP)\lib32\borland"
```

You can find examples for the C language in the Borland C subfolder of the `\Users\Public\Documents\National Instruments\NI-CAN\Examples` directory on Windows Vista and the `\Documents and Settings\All Users\Shared Documents\National Instruments\NI-CAN\Examples` directory on Windows XP. Each example is in a separate folder. A description of each example is in comments at the top of the `.c` file.

## Microsoft Visual Basic

The NI-CAN software supports Microsoft Visual Basic 6.0 or later.

To create an application in Visual Basic, add the NI-CAN Channel API.BAS or NI-CAN Frame API.BAS file with the WIN32 API.BAS file to the project. WIN32 API.BAS defines API calls to the Windows system which are called by functions defined in the NI-CAN Channel API.BAS and NI-CAN Frame API.BAS files. Adding these files to the project allows you to call any of the functions declared in them from the code.

The .BAS files are in the MS Visual Basic subfolder of the \Users\Public\Documents\National Instruments\NI-CAN\Examples directory on Windows Vista and the \Documents and Settings\All Users\Shared Documents\National Instruments\NI-CAN\Examples directory on Windows XP.

The reference for each NI-CAN Channel API function is in Chapter 8, [Channel API for C](#). The reference for each NI-CAN Frame API function is in Chapter 11, [Frame API for C](#).

If you plan to use the **ReadMult** or **WriteMult** functions, refer to the examples, which explain how to use the **Read Multiple** or **Write Multiple** functions instead.

You can find examples for Visual Basic in the Channel API examples and Frame API examples subfolders of the MS Visual Basic folder. Each example is in a separate folder. A .vbp file with the same name as the example opens the Visual Basic project. A description of the example is located in a Help form within the project.

## Other Programming Languages

The NI-CAN software does not provide formal support for programming languages other than those described in the preceding sections. Nevertheless, you may find libraries and examples for other programming languages on the National Instruments Web site, [ni.com](http://ni.com).

If the programming language provides a mechanism to call a Dynamic Link Library (DLL), you can create code to call NI-CAN functions. All functions for the Channel API and Frame API are in `nican.dll`.

If the programming language supports the Microsoft Win32 APIs, you can load pointers to NI-CAN functions in the application. The following text demonstrates use of the Win32 functions for C/C++ environments other than Visual C/C++ 6. For more detailed information, refer to Microsoft documentation.

The following C language code fragment shows how to call Win32 `LoadLibrary` to load the DLL for the NI-CAN Channel API:

```
#include <windows.h>
#include "nican.h"
HINSTANCE NicanLib = NULL;
NicanLib = LoadLibrary("nican.dll");
```

Next, the application must call the Win32 `GetProcAddress` function to obtain a pointer to each NI-CAN function that the application will use. For each NI-CAN function, you must declare a pointer variable using the prototype of the function. For the prototypes of each NI-CAN function, refer to the C language sections of this manual.

```
static nctTypeStatus (NCT_FUNC * PnctInitStart)
(const str TaskList, i32 Interface, i32 Direction,
f64 SampleRate, nctTypeTaskRef * TaskRef);
static nctTypeStatus (NCT_FUNC * PnctRead)
(nctTypeTaskRef TaskRef, u32 NumberOfSamplesToRead,
nctTypeTimestamp * StartTime, nctTypeTimestamp *
DeltaTime, f64 * SampleArray, u32 *
NumberOfSamplesReturned);
static nctTypeStatus (NCT_FUNC * PnctClear)
(nctTypeTaskRef TaskRef);
PnctInitStart = (nctTypeStatus (NCT_FUNC *)
(const str, i32, i32, f64, nctTypeTaskRef *))
GetProcAddress(NicanLib, (LPCSTR)"nctInitStart");
PnctRead = (nctTypeStatus (NCT_FUNC *)
(nctTypeTaskRef, u32, nctTypeTimestamp *,
nctTypeTimestamp *, f64 *, u32 *))
GetProcAddress(NicanLib, (LPCSTR)"nctRead");
PnctClear = (nctTypeStatus (NCT_FUNC *)
(nctTypeTaskRef)) GetProcAddress(NicanLib,
(LPCSTR)"nctClear");
```

The application must de-reference the pointer to call the NI-CAN function, as shown by the following code:

```
nctTypeStatus status;
nctTypeTaskRef TaskRef;
status = (*PnctInitStart)("mychannel1, mychannel2", 0,
nctModeInput, 1000.0, &TaskRef);
```

Before exiting the application, you must unload the NI-CAN DLL as follows:

```
FreeLibrary(NicanLib);
```

## Choose Which API To Use

---

For a given NI-CAN interface such as **CAN0**, you can use only one API at a time. Therefore, for new application development, you need to decide which API to use.

For example, if you have one application that uses the Channel API and another application that uses the Frame API, you cannot use **CAN0** with both at the same time. As an alternative, you can connect **CAN0** and **CAN1** to the same network, then use **CAN0** with one application and **CAN1** with the other, if you have a 2-port CAN card. As another alternative, you can use **CAN0** in both applications, but run each application at a different time (not simultaneously).

Because the Channel API provides access to the CAN network in easy-to-use physical units, it is recommended over the Frame API for customers who are getting started with NI-CAN. You also need to use the Channel API if you want to utilize CAN messages or channels that are defined in CAN database files.

Nevertheless, because the Frame API provides lower-level access to the CAN network, there are a few reasons why you might want to use it over the Channel API:

- You are continuing with an application developed with NI-CAN version 1.6 or earlier. The Frame API is compatible with such code.
- You need to implement a command/response protocol in which you send a command to the device, and then the device replies by sending a response. Command/response protocols typically use a fixed pair of IDs for each device, and the ID does not determine the meaning of the data bytes.

- The devices require use of remote frames. The Channel API does not provide support for remote frames, but the Frame API has extensive features to transmit and receive remote frames. For more information, refer to the [Remote Frames](#) section of Chapter 9, [Using the Frame API](#), in this manual.
- The Frame API provides RTSI features that are lower level than the synchronization features of the Channel API. If you have advanced requirements for synchronizing CAN and DAQ cards, you may need to use the Frame API. For more information, refer to the [RTSI](#) section of Chapter 9, [Using the Frame API](#), in this manual.
- The USB-847x is supported only by the Frame API. In addition, the USB-847x hardware uses the Network Interface, not CAN objects.

In some cases, applications might require the ability to convert CAN data between a CAN frame and a CAN channel. For information on frame to channel conversion, channel to frame conversion, and virtual interfaces, refer to the [Frame to Channel Conversion](#) section of Chapter 6, [Using the Channel API](#), in this manual.

# Using the Channel API

This chapter helps you get started with the Channel API.

## Choose Source of Channel Configuration

The first step in using the Channel API is to create the channel configuration for the applications. This channel configuration describes how the NI-CAN software converts raw data in messages to or from the physical units of each channel.

The NI-CAN software provides various methods to create the channel configuration. Figure 6-1 shows a process you can use to decide the source of the channel configuration. A description of each step in the decision process follows the flowchart.

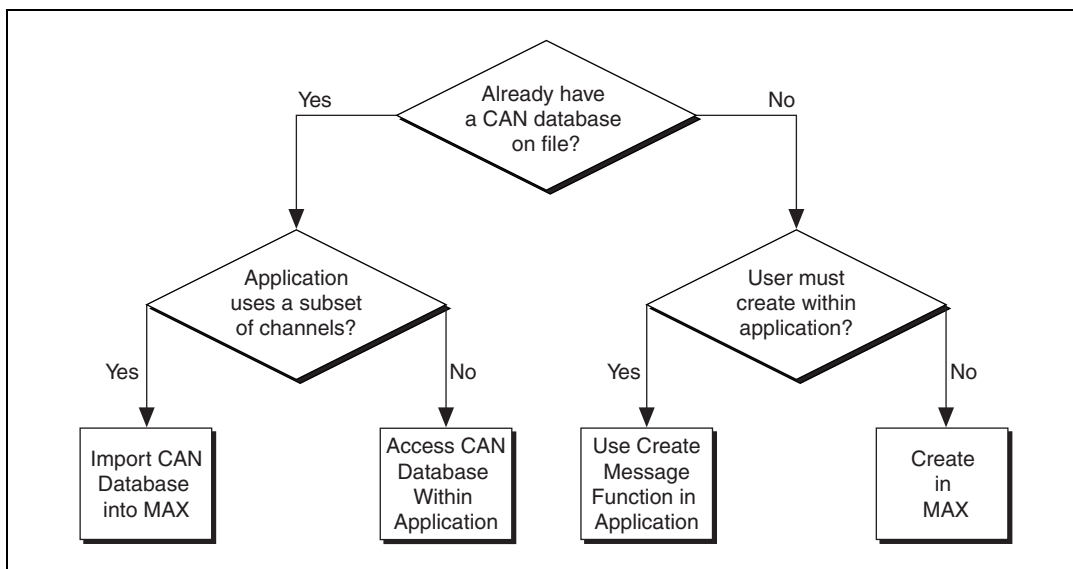

**Figure 6-1.** Decision Process for Choosing Source of Channel Configuration

## Already Have a CAN Database File?

If you have a CAN database file, the channel configuration has already been created using a tool such as Vector's CANdb Editor. You can use each signal name in the CAN database as a channel name in the NI-CAN Channel API.

If you answer yes, refer to the [Application Uses a Subset of Channels?](#) section of this chapter. If you answer no, refer to the [User Must Create within Application?](#) section of this chapter.

## Application Uses a Subset of Channels?

If the CAN database file contains a large number of channel descriptions (1,000 or more), does the application use only a subset of these channels (100 or less)? Importing the channels into MAX provides many benefits, but managing the transfer of large amounts of data from CAN databases can be cumbersome. For example, if the large CAN database file is updated periodically, you need to ensure that the changes are reflected in MAX after each update.

If you answer yes, refer to the [Import CAN Database into MAX](#) section of this chapter. If you answer no, refer to the [Access CAN Database within Application](#) section of this chapter.

There are limitations on how NI-CAN uses information from a Vector CANdb database file. For current information on NI-CAN support for Vector CANdb files, refer to the NI-CAN readme file.

## Import CAN Database into MAX

The benefits of importing channels into MAX include:

- The option of initializing the channel name alone within the Channel API. No path to the CAN database file is required.
- Using the **Test Panel** in MAX to read and write the channels.

To import channel configurations from a Vector CANdb file into MAX, right-click the **CAN Channels** heading, then select **Import from CANdb File**. Use shift-click to select multiple channels, and then select **Import**. If you need to select another set, you can select the channels and then **Import** again. When you are finished with the import, select **Done** to return to MAX.



You can download the MAX channel configuration to a LabVIEW RT system by right-clicking the **CAN Channels** heading, and selecting **Send to RT System**.

## Access CAN Database within Application

To access the CAN database within the application, you must initialize the channel name with the file path as a prefix. For example, if you are using a channel named `EngineRPM` in the `C:\DBC_Files\Prototype.DBC` file, you pass the following name to the **Init Start** function:

```
C:\DBC_Files\Prototype.DBC::EngineRPM
```

For more information, refer to the description of the **Init Start** function in the Channel API reference sections of this manual.

You can download the channel configuration to a LabVIEW RT system by right-clicking the **CAN Channels** heading, and selecting **Send to RT System**.

## User Must Create within Application?

Are you developing an application that another person will use, and that person must create the channel configuration using the application itself?

If you answer yes, refer to the [Use Create Message Function in Application](#) section of this chapter.

If you answer no, you create the channel configuration within MAX. You can save the MAX channel configuration to a file, so this method does not prevent you from deploying the application for use by others. For more information, refer to the [Create in MAX](#) section of this chapter.

## Use Create Message Function in Application

The Create Message function (**CAN Create Message** in LabVIEW and `nctCreateMessage` in other languages) takes inputs for a single message configuration, then one or more channel configurations. By using Create Message to create the channel configurations, the application is entirely self contained, not depending on MAX or a CAN database file.

The inputs to Create Message are relatively advanced for many users. Use of MAX or a CAN database helps to isolate the application end user from the specifics of CAN message encoding.

Mode dependent channels are a special kind of CAN message used within some networks. Refer to the [Mode Dependent Channels](#) section of this chapter for more information. If you must support creation of mode dependent channel configurations within the application, use the **Create MessageEx** function instead of **Create Message**. The **Create MessageEx** function provides extensions for creation of mode dependent as well as normal channels.

## Create in MAX

To create channel configurations within MAX, right-click the CAN Channels heading, then select **Create Message**. Enter the message properties, then select **OK**. Right-click the message name, then select **Create Channel**. Enter the channel properties, then select **OK**. Select **Create Channel** again for each channel contained in the message. Channel names are case sensitive.

To save channel configurations to a file, right-click the **CAN Channels** heading, then select **Save Channel Configuration**. The resulting NI-CAN database uses file extension `.ncd`. You can access the NI-CAN database using the `Init Start` function just like any other CAN database. By simply installing the NI-CAN database file along with the application, you can deploy the application to a variety of users.

## Channel API Basic Programming Model

---

When you use the Channel API, the first step is to initialize a list of channels with the same direction, such as input or output. You can then read or write this list of channels as a unit. The term *task* refers to a list of channels you read or write together. A common use of the task concept is to read/write all channels of a message.

Figure 6-2 shows a diagram describing the basic programming model for the NI-CAN Channel API. Within the application, you repeat this basic programming model for each task. The diagram is followed by a description of each step in the model.

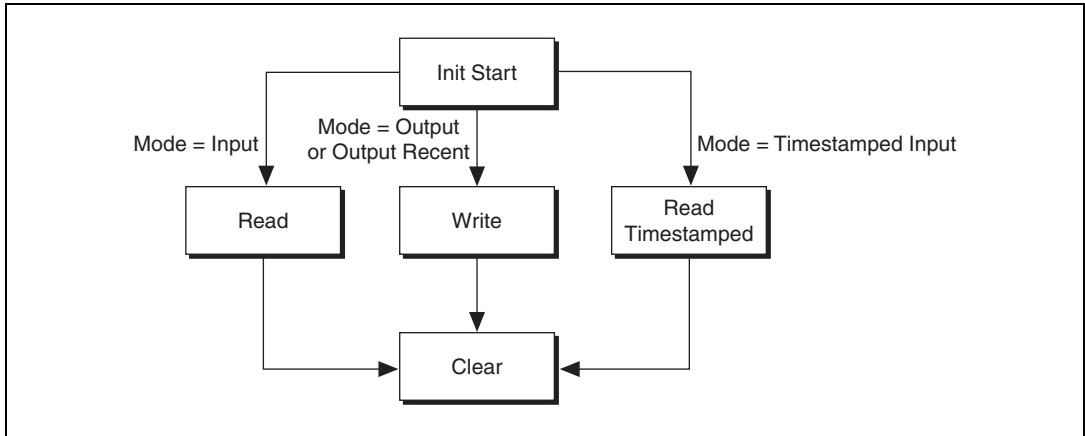

**Figure 6-2.** Basic Programming Model for Channel API

## Init Start

The `Init Start` function initializes a list of channels as a single task, then starts communication for that task.

The `Init Start` function uses the following input parameters:

- **channel list**—Specifies the list of channels for the task, with one string for each channel.
- **interface**—Specifies the CAN interface to use for the task. The interface is an enumeration in which 0 specifies CAN0, 1 specifies CAN1, and so on. The baud rate is taken from the properties of the interface in MAX.
- **mode**—Specifies the I/O mode to use for the task. This determines the direction of data transfer for the task (that is, Input or Output). It also determines the type of `Read` or `Write` function you use with the task. For more information, refer to the following sections.
- **sample rate**—Specifies the rate of sampling for input and output modes. The sample rate is specified in Hertz (samples per second). For more information, refer to the [Read](#) and [Write](#) sections of this chapter.

The `Init Start` function simply calls the `Initialize` function followed by the `Start` function. This provides an easy way to start a list of channels.

There are a few scenarios in which you cannot use Init Start:

- **Set Property**—If you need to set properties for the task, you must call Initialize, Set Property, and Start in sequence. For example, use Set Property if you need to specify the baud rate for the interface within the application. For more information, refer to the [Set Property](#) section of this chapter.
- **Synchronization**—If you need to synchronize multiple cards, you must call Initialize, then the appropriate functions to synchronize and start the cards. For more information, refer to the [Synchronization](#) section of this chapter.
- **Create Message**—If you need to create channel configurations within the application, you must call Create Message and Start in sequence. For assistance in deciding whether Create Message is appropriate for the application, refer to the [Choose Source of Channel Configuration](#) section of this chapter.

The Init Start function is **CAN Init Start** in LabVIEW and `nctInitStart` in other languages.

## Read

If the mode of Init Start is Input, the application must call the Read function to obtain floating-point samples. The application typically calls Read in a loop until done.

The Read function is **CAN Read** in LabVIEW (all types that don't end in **Time & Dbl**) and `nctRead` in other languages.

The behavior of Read depends on the initialized sample rate:

### sample rate = 0

Read returns a single sample from the most recent message(s) received from the network. One sample is returned for every channel in the Init Start list.

Figure 6-3, [Example of Read with sample rate = 0](#), shows an example of Read with sample rate = 0. *A*, *B*, and *C* represent messages for the initialized channels. If no message is received since the start of the application, the Default Value in MAX (*def*) is returned, along with a warning.

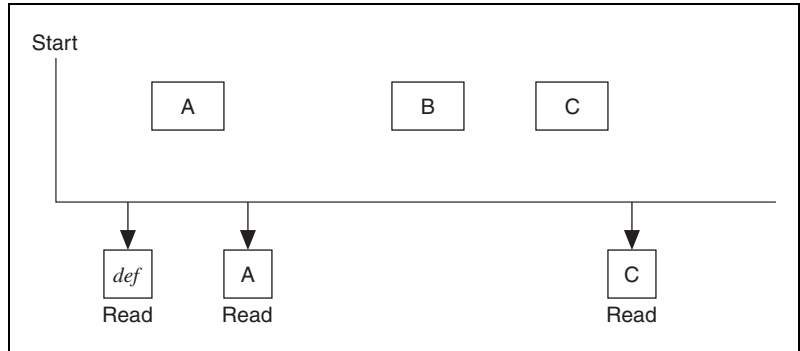
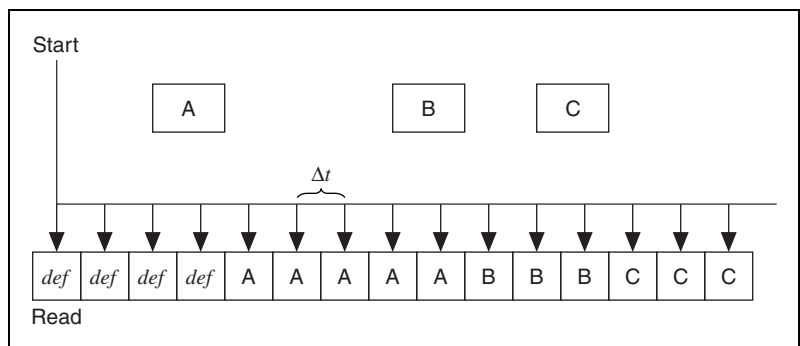

**Figure 6-3.** Example of Read with sample rate = 0

## sample rate > 0

Read returns an array of samples for every channel in the Init Start list. Each time the clock ticks at the specified rate, a sample from the most recent message(s) is inserted into the arrays. In other words, the samples are repeated in the array at the specified rate until a new message is received. By using the same sample rate with NI-DAQ Analog Input channels or NI-DAQmx Analog Input channels, you can compare CAN and DAQ samples over time.

Figure 6-4 shows an example of Read with sample rate > 0. *A*, *B*, and *C* represent messages for the initialized channels.  $\Delta t$  represents the time between samples as specified by the sample rate. *def* represents the Default Value in MAX.



**Figure 6-4.** Example of Read with sample rate > 0

## Read Timestamped

If the Init Start mode is Timestamped Input, the application must call the Read Timestamped function to obtain floating-point samples. The application typically calls Read Timestamped in a loop until done.

The Read Timestamped function returns samples that correspond to messages received from network. For each message, an associated sample is returned along with a timestamp that specifies when the message arrived. An array of timestamped samples is returned for every channel in the Init Start list.

The Read Timestamped function is **CAN Read** in LabVIEW (types that end in **Time & Dbl**) and `nctReadTimestamped` in other languages.

Figure 6-5 shows an example of Read Timestamped. *A*, *B*, and *C* represent messages for the initialized channels. *A<sub>t</sub>*, *B<sub>t</sub>*, and *C<sub>t</sub>* represent the times when each message was received.

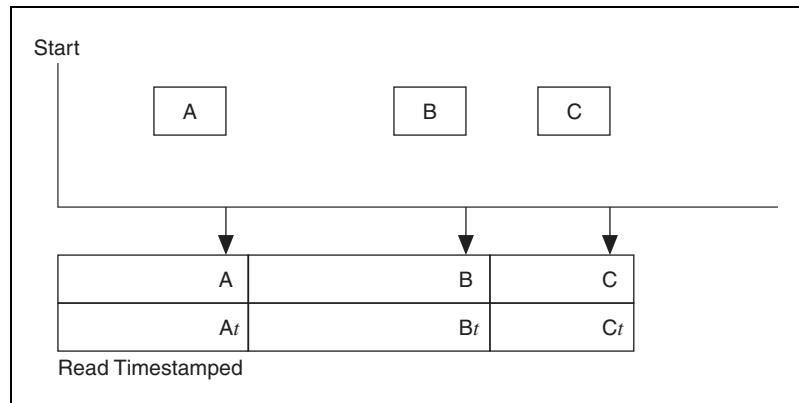

**Figure 6-5.** Example of Read Timestamped

## Write

If the Init Start mode is Output (or Output Recent), the application must call the Write function to output floating-point samples. The application typically calls Write in a loop until done.

The Write function is **CAN Write** in LabVIEW and `nctWrite` in other languages.

The behavior of Write depends on the initialized sample rate:

## sample rate = 0

Write transmits a message immediately on the network. The samples provided to write are used to form the data bytes of the message. One sample must be specified for every channel in the Init Start list. The Init Start mode must be Output for this behavior (not Output Recent).

Figure 6-6 shows an example of Write with sample rate = 0. *A*, *B*, *C* and *D* represent messages for the initialized channels. For each Write, the associated messages are transmitted as quickly as possible.

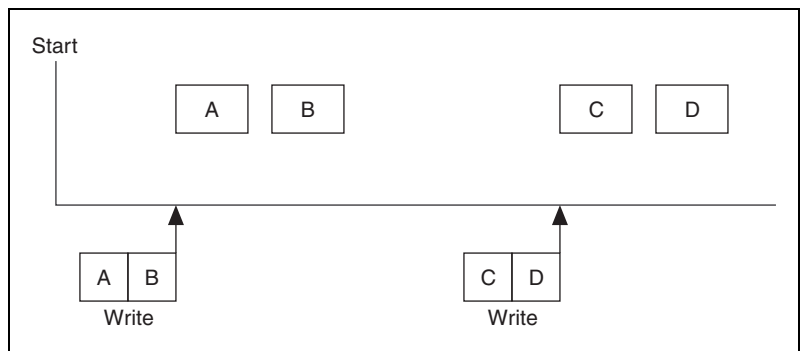

Figure 6-6. Example of Write with Sample Rate = 0

## sample rate > 0, Output mode

You provide an array of samples for every channel in the Init Start list. Each time the clock ticks at the specified rate, the next message is transmitted. Each message uses the next sample from the array(s) to form the data bytes of the message. In other words, the samples from the array are transmitted periodically onto the network. By using the same sample rate with NI-DAQ Analog Output channels or NI-DAQmx Analog Output channels, you can output synchronized CAN and DAQ samples over time.

Figure 6-7, *Example of Write with Sample Rate > 0, Output Mode*, shows an example of Write with sample rate > 0 and Output mode. *A*, *B*, *C* and *D* represent messages for the initialized channels.  $\langle \text{delta-t} \rangle$  represents the time between message transmission as specified by the sample rate.

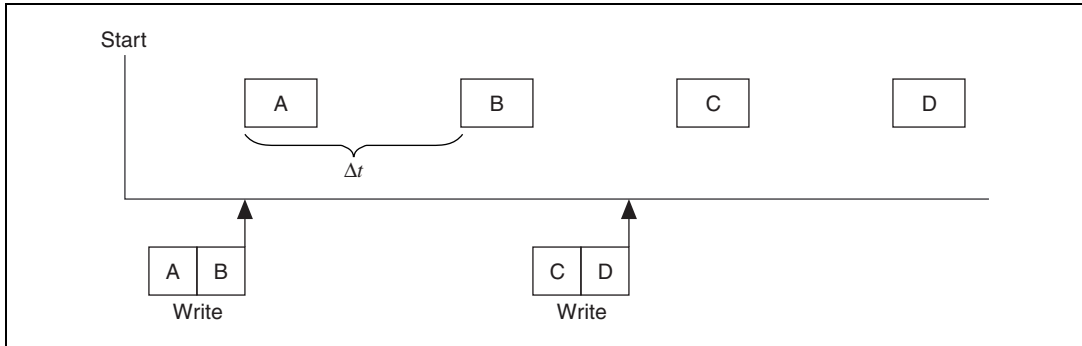

Figure 6-7. Example of Write with Sample Rate > 0, Output Mode

### sample rate > 0, Output Recent mode

You provide a single sample for every channel in the Init Start list. Each time the clock ticks at the specified rate, the next message is transmitted using the most recent sample that you provided. The Output Recent mode is useful when you have multiple tasks running at different rates, because you can write samples for all tasks in a single loop.

Figure 6-8 shows an example of Write with sample rate > 0 and Output Recent mode.

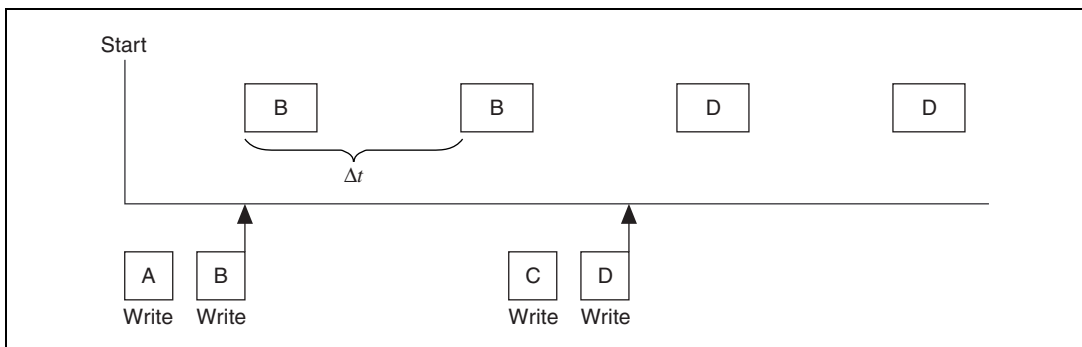

Figure 6-8. Example of Write with Sample Rate > 0, Output Recent Mode

## Clear

The Clear function stops communication for the task, then clears the configuration.

For every task that you initialize, you must call Clear prior to exiting the application.



The Clear function is **CAN Clear** in LabVIEW and `nctClear` in other languages.

## Channel API Additional Programming Topics

---

The following sections provide information you can use to extend the basic programming model.

### Get Names

If you are developing an application that another person will use, you may not want to specify a fixed channel list in the application. Ideally, you want the end-user to select the channels of interest from user interface controls, such as list boxes.

The Get Names function queries MAX or a CAN database and returns a list of all channels in that database. You can use this list to populate user-interface controls. The end-user can then select channels from these controls, avoiding the need to type each name using the keyboard. Once the user makes his selections, the application can pass the resulting list to Init Start.

The Get Names function is **CAN Get Names** in LabVIEW and `nctGetNames` in other languages.

### Synchronization

The NI-CAN Channel API uses RTSI to synchronize specific functional units on each card. For CAN cards, the functional unit is the interface (port). For DAQ cards, the functional unit is a specific measurement such as Analog Input or Analog Output. Each function routes two signals over the RTSI connection:

- **timebase**—This is a common clock shared by both cards. The shared timebase ensures that sampling does not drift. The timebase applies to all functional units on the card.
- **start trigger**—This signal is sent from one functional unit to the other functional unit when sampling starts. The shared start trigger ensures that both units start simultaneously.

## Set Property

The Init Start function uses interface and channel configuration as specified in MAX or the CAN database file. If you need to change this configuration within the application, you cannot use Init Start, because most properties cannot be changed while the task is running.

For example, to set the baud rate for the interface within the application, use the following calling sequence:

- Initialize the task as stopped. The Initialize function is **CAN Initialize** in LabVIEW and `nctInitialize` in other languages.
- Use Set Property to specify the new value for the baud rate property. The Set Property function is **CAN Set Property** in LabVIEW and `nctSetProperty` in other languages.
- Start the task with the Start function. The Start function is **CAN Start** in LabVIEW and `nctStart` in other languages.

After the task is started, you may need to change properties again. To change properties within the application, use the Stop function to stop the task, Set Property to change properties, and then Start the task again.

You also can use the Get Property function to get the value of any property. The Get Property function returns values whether the task is running or not.

## Frame to Channel Conversion

---

As described in the *NI-CAN Software Overview* section of Chapter 1, *Introduction*, NI-CAN supports two distinct formats for CAN data. The first format is the CAN frame, which represents a raw frame consisting of an ID, type, data bytes, and timestamp. The second format is the CAN channel, which represents a field in the data of a specific ID, scaled to a floating point value in physical units (such as Volts or Revolutions-per-minute).

Many applications require the ability to convert CAN data from one format to another. As one example, consider an application that logs CAN traffic to a file for an extended period of time. Since CAN frames occur in an event driven manner, the most efficient means of file storage is to use CAN frames as the data format. Nevertheless, when displaying the contents of the log file, you may need to plot the data as waveforms for specific CAN channels. Therefore, the application must convert the CAN frames in the file into CAN channels for waveform display.

Figure 6-9 demonstrates how you can use NI-CAN to display waveforms of CAN channels using a log file consisting of CAN frames. NI-CAN provides a virtual CAN card with two interfaces, CAN256 and CAN257. The two virtual interfaces are connected by a virtual bus. When you write CAN frames to one virtual interface, those frames are received by the other virtual interface, and can be read as channels. This feature allows you to read and write CAN data in the same manner as two real CAN interfaces connected by a real CAN cable. The conversion does not require real NI CAN hardware, and your application is not required to check for specific CAN IDs.

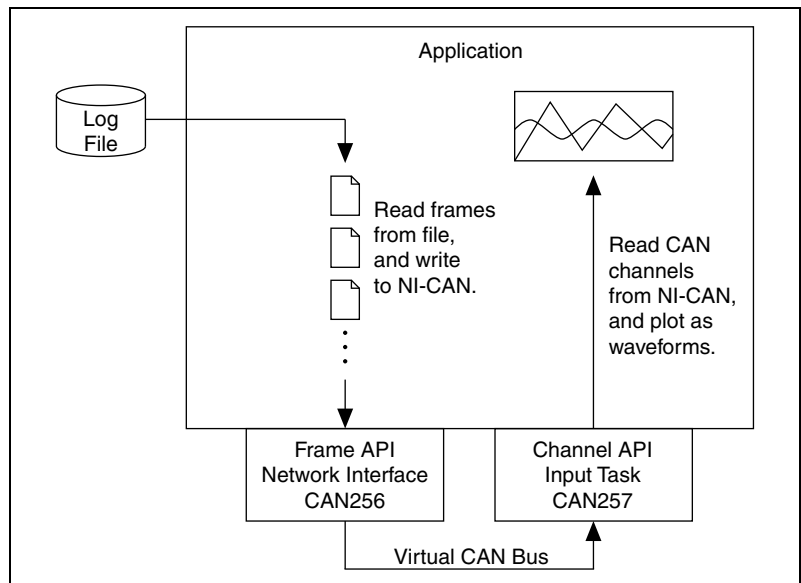

**Figure 6-9.** Display Waveforms of CAN Channels Using a Log File of CAN Frames

## When Should I Use Frame to Channel Conversion?

The following sections outline some applications that use frame to channel conversion, channel to frame conversion, or other aspects of the virtual interface concept.

### Logging

As explained in the Introduction, logging is one of the primary applications for frame to channel conversion. Since overall CAN traffic does not occur at a fixed rate, the most efficient implementation is to store each CAN frame as it is received. The file of CAN frames can later be displayed as channels using NI-CAN's frame to channel conversion.

In addition to displaying a log file as channels, you can also use NI-CAN to create a log file using channel data. The process for this channel to frame conversion is essentially a reversal of the operations shown in Figure 6-9 above. You obtain CAN channel data from front panel controls, and write that CAN channel data to a Channel API output task on a virtual interface (CAN257). Next, you read the resulting CAN frames from a Frame API virtual interface (CAN256), and write those frames to the log file. At a subsequent date, you can replay this log file to a real CAN interface using the timestamped transmit feature (**Transmit Mode** attribute of the Frame API network interface).

Although NI-CAN examples demonstrate a simple binary log file format, your logging or replay application can access any file format that you require. Although there is a wide variety of CAN log file formats available from other companies, almost all use CAN frames as the fundamental data type. Once you obtain the specification for a specific CAN log file format, it is relatively straightforward to convert the file contents to data that is compatible with the NI-CAN Frame API.

## CompactRIO

The rugged enclosure and real-time capabilities of CompactRIO, as discussed in the *CAN for CompactRIO* section of Chapter 3, *NI CAN and LIN Hardware*, make it an ideal product for testing in the field, such as drive testing of an automobile. Since the LabVIEW FPGA I/O interface for CAN provides access to CAN frames only, you must use NI-CAN's frame to channel conversion features when access to CAN channels is required.

For logging applications, the LabVIEW application on CompactRIO is simple: read CAN frames and store them in a file. When the CAN log file is later transferred from CompactRIO to a lab computer, the application on that computer can use NI-CAN to read frames from the log file and display as CAN channels, as shown in Figure 6-1. In addition, if the LabVIEW application on CompactRIO stores a second log file with analog/digital samples, that data can be displayed on the lab computer as waveforms synchronized with the CAN channels.

For applications in which you must execute a control model within CompactRIO, you typically wire CAN channels as inputs and outputs to the control model. In order to implement this, you can install NI-CAN on the LabVIEW RT controller of CompactRIO. Your LabVIEW FPGA VI reads and writes CAN frames, and transfers those CAN frames to/from LabVIEW RT as you would any other I/O. Your LabVIEW RT VI uses NI-CAN's virtual interfaces to convert the CAN frames to/from CAN channels. Your NI-CAN Channel API tasks use sample rate 0 and

single-sample read/write, thus providing immediate single-point values for the control model.

## Development without CAN Hardware

The virtual interface can enable development of an NI-CAN application on a computer that does not contain NI CAN hardware. Although the NI-CAN virtual interface does impose some limitations, most functions return successful status. In addition, the virtual bus feature may enable you to debug your application by simulating limited CAN traffic. For example, if your application is intended to test a CAN *node*, you can run your test on CAN256, and run a simple simulation of the node on CAN257.

## Database Queries

For large test applications that are deployed to several end-users, it is common to query CAN databases for initial configuration of a test. For example, you specify a list of channel names, each with parameters for display in a single waveform graph, then save that test configuration to a file. The application that queries the CAN database to create a test configuration file often executes on a system without NI CAN hardware.

By initializing a Channel API task on CAN256, you can use the CAN Get Property function to obtain detailed information for each message and channel in a CAN database.

## Enhance an Existing Frame API Application

You have a large Frame API application for an older version of NI-CAN (1.x), and that application can benefit from display of CAN data as channels. Rather than changing all of the application's CAN communication from the Frame API to the Channel API, you can use frame to channel conversion to enhance the existing code. For example, the bulk of the application can communicate on a real interface (i.e. CAN0) using the Frame API, but you can add code that uses virtual interfaces to convert raw frame data to/from channel data for additional displays.

## USB-847x

The USB-847x hardware is supported only by the Frame API. For some applications with the USB-847x you may want to display CAN data as channels. In this case you can use frame to channel conversion to convert the frame data into channel data for display.

## Virtual Bus Timing

The NI-CAN virtual interface provides an attribute that does not exist on real interfaces. Virtual Bus Timing is a boolean attribute that specifies whether the time between successive CAN frames is simulated by NI-CAN when the frames transfer across the virtual bus.

When Virtual Bus Timing is true (default), the time between frames is simulated. Frame timestamps are recalculated as they transfer across the virtual bus. This mode is useful when you want the virtual bus to behave as much like a real bus as possible. For example, if you use the technique shown in Figure 6-1 to display a log file that was captured over 200 seconds of time, the channel waveforms will scroll slowly to display data for 200 seconds. This is due to the fact that when you write two frames whose timestamps are a few seconds apart, NI-CAN will delay a few seconds on the virtual bus, and therefore the Channel API Read of CAN257 will delay between the two frames. The programming model used to write NI-CAN applications for real CAN hardware can be used for a majority of applications with Virtual Bus Timing enabled. Refer to the *Channel API Basic Programming Model* of this chapter and the *Frame API Basic Programming Model for CAN* section of Chapter 9, *Using the Frame API*, for information on programming real CAN hardware.

When Virtual Bus Timing is false, the time between frames is not simulated. Frame timestamps are unchanged as they transfer across the virtual bus. This mode is useful when you want to convert CAN data from frames to channels as quickly as possible. For example, if you use the technique shown in Figure 6-1 to display a log file that was captured over 200 seconds of time, the channel waveforms will scroll by very quickly. This is due to the fact that when you write two frames whose timestamps are a few seconds apart, NI-CAN will not delay the transfer on the virtual bus, and therefore the Channel API Read of CAN257 will not delay between the two frames. Although the conversion occurs quickly, you will presumably use products like LabVIEW or DIAdem to search the waveforms for specific events. When Virtual Bus Timing is disabled, time advances only up to the timestamp of the last frame written onto the virtual bus. As a result, if NI-CAN detects that a frame with a timestamp lesser than the previous frame timestamp is being written onto the virtual bus, an error will be returned. Refer to the *Programming Model for Virtual Bus Timing Disabled* section of this chapter for information on developing an application that converts frames to channels or channels to frames without simulating frame timing.

When you change the Virtual Bus Timing in your application, you must set the same value on both virtual interfaces, CAN256 and CAN257.

## Limitations

The virtual interface is not designed to support all of the features of a real interface. This section serves as the primary reference for the limitations of the virtual interface.

For each NI-CAN feature, the virtual interface will behave in one of three ways:

- **Error**—The NI-CAN function returns an error. This occurs for features that are not supported, and which represent high-level capabilities that your application would require. For example, the virtual interface does not support Frame API CAN Objects, so the error helps to clarify that you cannot execute applications that rely on CAN Objects.
- **Non-operational**—The NI-CAN function returns success, but the feature performs in a fixed, non-operational manner. This occurs for features that your application typically would not rely on. For example, the virtual interface always returns zero for the **Serial Number** attribute, because your application may display the serial number, but operate correctly when the number is invalid.
- **Operational**—The NI-CAN function returns success, and operates as expected with regard to the virtual bus. For example, if you write a frame to a virtual network interface using the Frame API, that frame will transfer across the virtual bus to the other virtual interface.

Table 6-1 lists all **Error** features for the virtual interface. The VBT column lists the values (T=true, F=false) of the Virtual Bus Timing attribute for which the **Error** behavior applies. If the VBT column lists both T and F, then Virtual Bus Timing does not affect the **Error** feature listed.

Table 6-2 lists all **Operational** features for the virtual interface. The VBT column lists the values (T=true, F=false) of the Virtual Bus Timing attribute for which the **Operational** behavior applies. If the VBT column lists both T and F, then Virtual Bus Timing does not affect the **Operational** features listed.

All features that are not explicitly listed in these tables are **Non-operational**. The behavior of **Non-operational** features is not documented in this manual. Your application should not make assumptions regarding the behavior of **Non-operational** features beyond the fact that NI-CAN returns success.

**Table 6-1.** Error Features for the Virtual Interface

Feature	VBT	Explanation
Channel API: Initialize of Output (or Output Recent) mode with Sample Rate greater than 0	T, F	The virtual interface does not support periodic timing for transmit. For channel to frame conversion, you must set the Channel API sample rate to 0, and perform periodic timing within your application.
Channel API: Set Property of Timestamp Format	F	Since timestamps are not changed when <b>Virtual Bus Timing</b> is false, this attribute does not apply.
Frame API: Open of CAN Object	T, F	CAN Objects are not supported. For the Frame API, the virtual interface is limited to the Network Interface.
Frame API: Read (or ReadMult) of Delay frame	F	When virtual bus timing is disabled, the virtual interface does not simulate timing between frames, so the Delay frame does not apply. For information on the Delay frame, refer to <a href="#">ncWriteNetMult.vi</a> (LabVIEW) or <a href="#">ncWriteMult</a> (C/C++).
Frame API: Set Attribute of Log Comm Warnings	T, F	The special Comm Warnings frame is not supported on virtual interfaces. If you write this frame, it will not be received on the other interface.
Frame API: Set Attribute of Timestamp Format	F	Since timestamps are not changed when <b>Virtual Bus Timing</b> is false, this attribute does not apply. The error is returned when an interface or task is started.
Frame API: Set Attribute of Transmit Mode	F	Since timestamps are not interpreted when <b>Virtual Bus Timing</b> is false, this attribute does not apply. The error is returned when an interface or task is started.
Frame API: Wait (or CreateNotification or CreateOccurrence) for any state except Write Multiple	F	When virtual bus timing is disabled, the virtual interface is limited to quick conversion of frames to/from channels. The <b>Write Multiple</b> state remains useful for streaming of frames to channels, but other states do not apply.



**Table 6-2.** Operational Features for the Virtual Interface

<b>Feature</b>	<b>VBT</b>	<b>Explanation</b>
Channel API: Clear	T, F	As with a real interface, the Channel API task for a virtual interface must be cleared.
Channel API: Get Property of Message or Channel properties	T, F	Useful for database queries. You pass the filepath for the database into the original Initialize function.
Channel API: Initialize of Input mode with Sample Rate equal 0	T, F	Read most recent value for each channel. Useful for simulated control models.
Channel API: Initialize of Input mode with Sample Rate greater than 0	T, F	Read periodically sampled values for each channel. Useful to display frames in waveform graphs.
Channel API: Initialize of Timestamped Input mode	T, F	Read timestamped samples.
Channel API: Initialize of Output (or Output Recent) mode with Sample Rate equal 0	T, F	Write channel values to transmit a frame. Useful for simulated control models, or to create a log file.
Channel API: Read	T, F	Read channels that correspond to frames received from the virtual bus. All Read types are supported.
Channel API: Set Property of Timestamp Format	T	Determines whether to use absolute or relative timestamps when reading frames from the virtual bus.
Channel API: Start or Stop	T, F	Controls whether frames are transmitted to or received from the virtual bus. Start includes the <b>Init Start</b> function.
Channel API: Write	T, F	Write channels that correspond to frames transmitted to the virtual bus. All Write types are supported.
Frame API: Action of Start or Stop	T, F	Controls whether frames are transmitted to or received from the virtual bus. Action opcodes for <b>Reset</b> and <b>RTSI Output</b> are Non-operational.
Frame API: Close	T, F	As with a real Network Interface, the virtual Network Interface must be closed.

**Table 6-2.** Operational Features for the Virtual Interface (Continued)

Feature	VBT	Explanation
Frame API: Config of Network Interface	T, F	The only valid attribute is <b>Start On Open</b> . All other attributes are ignored. The only valid virtual interface names are CAN256 and CAN257.
Frame API: Get Attribute of Read Entries Pending	T, F	Returns the number of frames pending in virtual Network Interface read queue.
Frame API: Get Attribute of Read Mult Size for Notification	T	Returns the number of frames used as a threshold for the <b>Read Multiple</b> state.
Frame API: Get Attribute of Write Entries Free	T	Returns the number of frames that can be accepted to write without causing an overflow error.
Frame API: Get Attribute of Write Entries Pending	T, F	Returns the number of frames pending in virtual Network Interface write queue.
Frame API: Open of Network Interface	T, F	Config of the Network Interface is ignored (Non-operational). The only valid virtual interface names are CAN256 and CAN257.
Frame API: Read or ReadMult	T, F	Receive frames from the virtual bus. When <b>Virtual Bus Mode</b> is true (default), Delay frames are operational. For information on the Delay frame, refer to <a href="#">ncWriteNetMult.vi</a> (LabVIEW) or <a href="#">ncWriteMult</a> (C/C++).
Frame API: Set Attribute of Log Start Trigger	T, F	Determine whether to return a start trigger frame from ReadMult. Start trigger frames are useful for logging/replay applications.
Frame API: Set Attribute of Read Mult Size for Notification	T	Sets the number of frames used as a threshold for the <b>Read Multiple</b> state. For more information on the <b>Read Multiple</b> state, refer to <a href="#">ncWaitForState.vi</a> .
Frame API: Set Attribute of Timeline Recovery	T	Determine whether to perform timeline recovery for simulated bus timing.

**Table 6-2.** Operational Features for the Virtual Interface (Continued)

Feature	VBT	Explanation
Frame API: Set Attribute of Timestamp Format	T	Determines whether to use absolute or relative timestamps when reading frames from the virtual bus.
Frame API: Set Attribute of Transmit Mode	T	When you submit timestamped frames to WriteMult, this determines whether to delay between frames.
Frame API: Wait (or CreateNotification or CreateOccurrence)	T	All states are operational only when <b>Virtual Bus Timing</b> is true (default).
Frame API: Wait (or CreateNotification or CreateOccurrence) for Write Multiple state	T, F	The <b>Write Multiple</b> state is useful for streaming of frames to channels, so it is supported for both <b>Virtual Bus Timing</b> values.
Frame API: Write or WriteMult	T, F	Transmit frames to the virtual bus.

## Programming Model for Virtual Bus Timing Disabled

There are some key rules to keep in mind while writing an application that does Frame to Channel Conversion or Channel to Frame Conversion with Virtual Bus Timing disabled:

- Do the Frame to Channel/ Channel to Frame Conversion within the same thread/process. In LabVIEW, create a single VI to transmit the CAN frames using [ncWriteNetMult.vi](#) and perform channel read using [CAN Read.vi](#).
- The Channel API Read task on the first virtual CAN interface requires a CAN frame to be written into the buffer of the second virtual CAN interface for it to start. Therefore, ensure that your application is written such that the first CAN frame is written using [ncWriteNetMult.vi](#) before the Channel API task times out.

The following steps demonstrate how to write a typical Frame to Channel Conversion application using both the NI-CAN APIs together.

1. Configure and Open the CAN Network Interface Object.

Prior to opening and communicating on a CAN port, you must configure the CAN Network Interface Object. Configure the CAN Network Interface Object using ncConfigNet. Set **Start on Open** to FALSE. Specify CAN256 as the ObjName.

- Open the CAN Network Interface Object by calling **ncOpen.vi**. Specify CAN256 as the ObjName.
2. Initialize the Channel API task.  
Initialize the CAN channels in your application using **CAN Initialize.vi**. Specify CAN257 as the Interface.
3. Disable Virtual Bus Timing on CAN256.  
Turn Virtual Bus Timing off on CAN256 (Frame API Object) by calling **ncSetAttr.vi** for Virtual Bus Timing with a value 0.
4. Disable Virtual Bus Timing on CAN257.  
Turn Virtual Bus Timing off on CAN257 (Channel API task) by calling **CAN Set Property.vi** for Virtual Bus Timing with a value 0.
5. Start Communication on the Virtual Bus (CAN256).  
Start communication on the CAN Network Interface Object (CAN256) by calling **ncAction.vi** with **Start** as the opcode.
6. Start Communication on the Virtual Bus (CAN257).  
Start communication on the CAN channel task for virtual interface CAN257 by calling **CAN Start.vi**.
7. Write CAN frames on to the Virtual Bus (CAN256).  
Transmit frames on the virtual bus by calling **ncWriteNetMult.vi** on CAN256. If the size of the frames array is greater than 512, call **ncWriteNetMult.vi** within a loop and with a subset of the total data frames each iteration of the loop.
8. Read the CAN frames as Channels (CAN 257).  
Read CAN frames as channels by calling **CAN Read.vi** on the channel task. You can use any of the Read types (single point read, waveform read or timestamped read). Refer to the *Read* section of this chapter for more information on the different CAN Read types.
9. Stop and Close the communication on the CAN Network Interface Object (CAN 256).  
Close the virtual interface (CAN256) by calling **ncClose.vi**.
10. Clear the Channel API task (CAN257).  
Clear the virtual task on CAN257 by calling **CAN Clear.vi**.

# Mode Dependent Channels

---

By definition, CAN supports a limited number of unique identifiers to transmit data between the nodes of a network. In some cases the number of available identifiers is too small to transmit all of the data, so an extension to these identifiers is needed. The concept of *mode dependent messages* defines a mode channel that functions like a sub-identifier within a CAN frame to determine the meaning of the rest of the data transmitted in the frame.

The mode channel is an implicit channel inside the CAN frame that cannot be accessed by an application for read or write operations. Each channel that relies on a mode channel is associated to a certain mode of that mode channel. This way the mode channel determines the distribution of the data in a CAN frame to the associated CAN channels in the application. Since a single CAN frame no longer contains data for all of these mode dependent channels associated with a CAN message, mode dependent channel data is buffered inside the NI-CAN driver. If the application reads data from a channel, the most recent received value will be returned for that channel. Writing data from mode dependent channels will result in sending one CAN frame per mode, defined for the appropriate task. If more than one mode channel is defined for a CAN message, the NI-CAN driver assures that each mode of each mode channel is sent at least once with every write operation.

For periodic data transmission the property **Message Multiple Frame Distribution** determines the mode for the transmission of the CAN frames of the appropriate CAN message. If **Message Multiple Frame Distribution** is set to `Uniform`, the CAN frames are sent equally distributed within the time frame selected for the transmission. If **Message Multiple Frame Distribution** is set to `Burst`, all CAN frames associated to the CAN message will be transmitted as fast as possible at the beginning of the time frame selected for the transmission.

As mentioned before, a consequence of using mode dependent channels is that not every CAN frame received contains data for all channels associated with the appropriate CAN message. If you are reading data in timestamped mode for normal CAN channels, you receive data for all of the channels associated with the CAN message and timestamp information denoting when the data was received by the CAN interface. In the case of mode dependent channels, you get valid data only for those channels that were part of the most recent CAN frame, along with the timestamp denoting when the frame was received by the CAN interface.

The data of any mode dependent channel is invalid if it is not transmitted with the most recent CAN frame associated with the CAN message. The invalid data is replaced with a special value. Before you can start a CAN task that uses mode dependent messages, you have to define the special value for these cases by setting the property **Value for Invalid Data**.

## Mode Dependent Channels in MAX

Mode dependent channels can be defined interactively in MAX. To create mode dependent channels in MAX, right-click on a message and create a multiplexer, as shown in Figure 6-10.

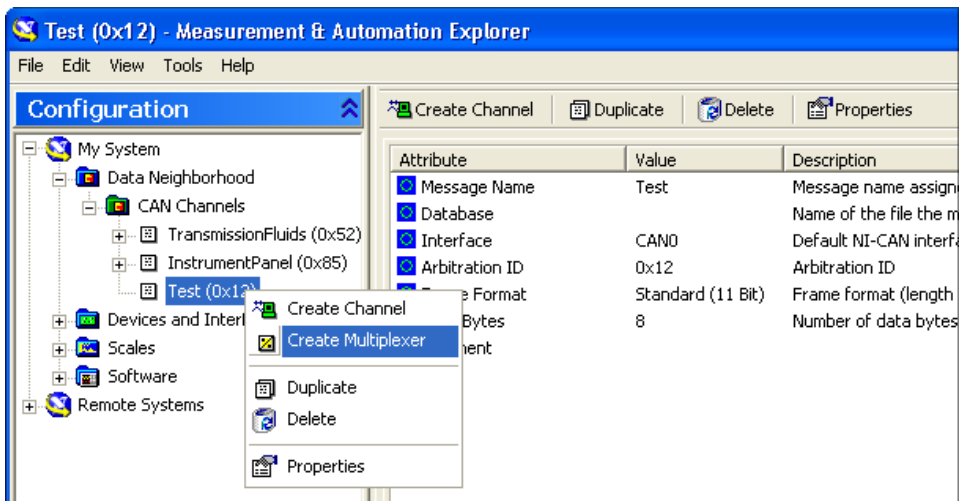
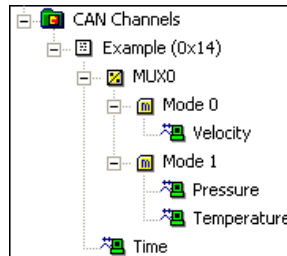

Figure 6-10. Creating a Multiplexer in MAX

Within the multiplexer dialog box define the properties of the mode channel. On a multiplexer item create a mode item and define the value of the mode channel (mode value). On a mode item, create channels which are only valid when the mode-channel contains the specified mode value. The channels of different modes in the same multiplexer may overlap each other, as shown in Figure 6-11, *Mode Dependent Channels in the MAX Configuration Tree*.



**Figure 6-11.** Mode Dependent Channels in the MAX Configuration Tree

# Channel API for LabVIEW

This chapter lists the LabVIEW VIs for the NI-CAN Channel API and describes the format, purpose, and parameters for each VI. The VIs are listed alphabetically.

Unless otherwise stated, each NI-CAN VI suspends execution of the calling thread until it completes.

## Section Headings

The following are section headings found in the Channel API for LabVIEW VIs.

### Purpose

Each VI description includes a brief statement of the purpose of the VI.

### Format

The format section describes the format of each VI.

### Input and Output

The input and output parameters for each VI are listed.

### Description

The description section gives details about the purpose and effect of each VI.

## List of VIs

Table 7-1 is an alphabetical list of the NI-CAN VIs for the Channel API.

**Table 7-1.** Channel API for LabVIEW VIs

Function	Purpose
<a href="#">CAN Clear.vi</a>	Stop communication for the task and then clear the configuration.
<a href="#">CAN Clear with NI-DAQ.vi</a>	Stop and clear the CAN task and the NI-DAQ task synchronized with <a href="#">CAN Sync Start with NI-DAQ.vi</a> .



**Table 7-1.** Channel API for LabVIEW VIs (Continued)

Function	Purpose
<b>CAN Clear with NI-DAQmx.vi</b>	Stop and clear the CAN task and the NI-DAQmx task synchronized with <b>CAN Sync Start with NI-DAQmx.vi</b> .
<b>CAN Clear Multiple with NI-DAQ.vi</b>	Stop and clear the list of CAN tasks and the list of NI-DAQ tasks synchronized with <b>CAN Sync Start Multiple with NI-DAQ.vi</b> .
<b>CAN Clear Multiple with NI-DAQmx.vi</b>	Stop and clear the list of CAN tasks and the list of NI-DAQmx tasks synchronized with <b>CAN Sync Start Multiple with NI-DAQmx.vi</b> .
<b>CAN Connect Terminals.vi</b>	Connect a terminal in the CAN hardware.
<b>CAN Create Message.vi</b>	Create a message configuration and associated channel configurations within the LabVIEW application.
<b>CAN Create MessageEx.vi</b>	Create a message configuration and associated channel configurations within the LabVIEW application. In addition you can specify mode dependent channels with <b>CAN Create MessageEx.vi</b> . For more information about mode dependent channels, refer to the <i>Mode Dependent Channels</i> section of Chapter 6, <i>Using the Channel API</i> .
<b>CAN Disconnect Terminals.vi</b>	Disconnect terminals in the CAN hardware.
<b>CAN Get Names.vi</b>	Get an array of CAN channel names or message names from MAX or a CAN database file.
<b>CAN Get Property.vi</b>	Get a property for the task, or a single channel within the task. The poly VI selection determines the property to get.
<b>CAN Initialize.vi</b>	Initialize a task for the specified channel list.
<b>CAN Init Start.vi</b>	Initialize a task for the specified channel list, then start communication.
<b>CAN Read.vi</b>	Read samples from a CAN task initialized as input. Samples are obtained from received CAN messages. The poly VI selection determines the data type to read.

**Table 7-1.** Channel API for LabVIEW VIs (Continued)

Function	Purpose
<b>CAN Set Property.vi</b>	Set a property for the task, or a single channel within the task. The poly VI selection determines the property to set.
<b>CAN Start.vi</b>	Start communication for the specified task.
<b>CAN Stop.vi</b>	Stop communication for the specified task.
<b>CAN Sync Start with NI-DAQ.vi</b>	Synchronize and start the specified CAN task and NI-DAQ task.
<b>CAN Sync Start with NI-DAQmx.vi</b>	Synchronize and start the specified CAN task and NI-DAQmx task.
<b>CAN Sync Start Multiple with NI-DAQ.vi</b>	Synchronize and start the specified list of multiple CAN tasks and NI-DAQ tasks. This is a more complex implementation of <b>CAN Sync Start with NI-DAQ.vi</b> that supports multiple CAN and a single NI-DAQ hardware product.
<b>CAN Sync Start Multiple with NI-DAQmx.vi</b>	Synchronize and start the specified list of multiple CAN tasks and NI-DAQmx tasks. This is a more complex implementation of <b>CAN Sync Start with NI-DAQmx.vi</b> that supports multiple CAN and a single NI-DAQmx hardware product.
<b>CAN Write.vi</b>	Write samples to a CAN task initialized as Output. (Refer to the <b>mode</b> parameter of <b>CAN Init Start.vi</b> .) Samples are placed into transmitted CAN messages. The poly VI selection determines the data type to write.

## CAN Clear.vi

### Purpose

Stop communication for the task and then clear the configuration.

### Format

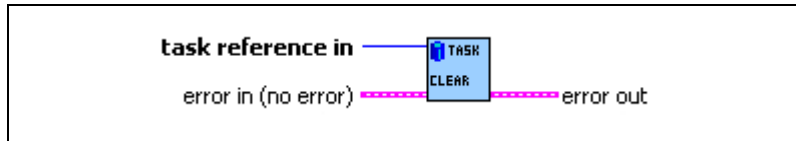

### Inputs



**task reference in** is the task reference from the previous NI-CAN VI. The task reference is originally returned from **CAN Init Start.vi**, **CAN Initialize.vi**, or **CAN Create Message.vi**, and then wired through subsequent VIs.



**Error in** describes error conditions occurring before the VI executes. If an error has already occurred, the VI returns the value of the **Error in** cluster in **Error out**.



**status** is True if an error occurred. Unlike other VIs, this VI will execute when **status** is True.



**code** is the error code number identifying an error. A value of 0 means success. A negative value means error: VI did not execute the intended operation. A positive value means warning: VI executed intended operation, but an informational warning is returned. For a description of the **code**, wire the error cluster to a LabVIEW error-handling VI, such as the Simple Error Handler.



**source** identifies the VI where the error occurred.

## Outputs



**Error out** describes error conditions. If the **Error in** cluster indicated an error, the **Error out** cluster contains the same information. Otherwise, **Error out** describes the error status of this VI.



**status** is True if an error occurred.



**code** is the error code number identifying an error. A value of 0 means success. A negative value means error: VI did not execute the intended operation. A positive value means warning: VI executed intended operation, but an informational warning is returned. For a description of the **code**, wire the error cluster to a LabVIEW error-handling VI, such as the Simple Error Handler.



**source** identifies the VI where the error occurred.

## Description

The **CAN Clear** VI must always be the final NI-CAN VI called for each task. If you do not use the **CAN Clear** VI, the remaining task configurations can cause problems in execution of subsequent NI-CAN applications.

If the cleared task is the last running task for the initialized interface (refer to [CAN Init Start.vi](#)), the **CAN Clear** VI also stops communication on the CAN controller of the interface and disconnects all terminal connections for that interface.

Unlike other VIs, this VI will execute when **status** is True in **Error in**.

Because this VI clears the task, the task reference is not wired as an output. To change properties of a running task, use [CAN Stop.vi](#) to stop the task, [CAN Set Property.vi](#) to change the desired property, and then [CAN Start.vi](#) to restart the task.

## CAN Clear with NI-DAQ.vi

### Purpose

Stop and clear the CAN task and the NI-DAQ task synchronized with **CAN Sync Start with NI-DAQ.vi**.

### Format

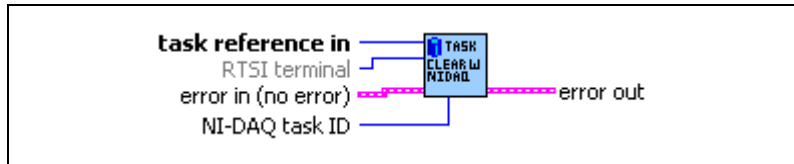

### Inputs



**task reference in** is the NI-CAN task reference you passed through the **CAN Sync Start with NI-DAQ VI**.



If you wire the same **RTSI terminal** that you passed into **CAN Sync Start with NI-DAQ.vi**, this VI clears the routing in NI-DAQ. If you leave **RTSI terminal** unwired, the VI retains the routing in NI-DAQ. This VI always clears RTSI routing for NI-CAN.



**NI-DAQ task ID** is the same NI-DAQ task ID you wired into the **CAN Sync Start with NI-DAQ VI**.



**Error in** describes error conditions occurring before the VI executes. If an error has already occurred, the VI returns the value of the **Error in** cluster in **Error out**.



**status** is True if an error occurred. If **status** is True, the VI does not perform any operations.



**code** is the error code number identifying an error. A value of 0 means success. A negative value means error: VI did not execute the intended operation. A positive value means warning: VI executed intended operation, but an informational warning is returned. For a description of the **code**, wire the error cluster to a LabVIEW error-handling VI, such as the Simple Error Handler.



**source** identifies the VI where the error occurred.

## Outputs



**Error out** describes error conditions. If the **Error in** cluster indicated an error, the **Error out** cluster contains the same information. Otherwise, **Error out** describes the error status of this VI.



**status** is True if an error occurred.



**code** is the error code number identifying an error. A value of 0 means success. A negative value means error: VI did not execute the intended operation. A positive value means warning: VI executed intended operation, but an informational warning is returned. For a description of the **code**, wire the error cluster to a LabVIEW error-handling VI, such as the Simple Error Handler.



**source** identifies the VI where the error occurred.

## Description

This VI is intended to serve as an example. You can use the VI as is, but the LabVIEW diagram is commented so that you can use the VI as a starting point for more complex synchronization scenarios. Before you customize the LabVIEW diagram, save a copy of the VI for editing.

## CAN Clear with NI-DAQmx.vi

### Purpose

Stop and clear the CAN task and the NI-DAQmx task synchronized with [CAN Sync Start with NI-DAQmx.vi](#).

### Format

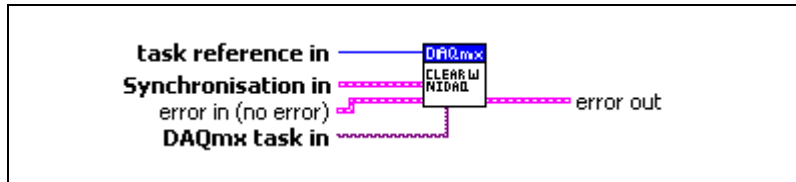

### Inputs



**task reference in** is the NI-CAN task reference you passed through the [CAN Sync Start with NI-DAQmx VI](#).



**Synchronization in** defines a cluster with information about the signals that have been routed between the cards and about additional DAQmx tasks that may have been created for synchronization. This information is needed to clear the routings in the NI-CAN and the NI-DAQmx devices after the measurement has been finished.



**Counter task in** is the task from an NI-DAQmx Create Virtual Channel VI. This additional NI-DAQmx task is created under certain circumstances to generate a common timebase clock for cards that do not support sharing of timebases through RTSI (like DAQ cards or NI-CAN Series 1 cards).



**Routes out** is a 1-dimensional array of terminal names of signals that have been routed between the cards.



**Source terminal** is the name of the terminal where the route starts.



**Destination terminal** is the name of the terminal where the route ends.



**DAQmx task in** is the same DAQmx task in you wired into [CAN Sync Start with NI-DAQmx.vi](#).

## Outputs



**Error out** describes error conditions. If the **Error in** cluster indicated an error, the **Error out** cluster contains the same information. Otherwise, **Error out** describes the error status of this VI.



**status** is True if an error occurred.



**code** is the error code number identifying an error. A value of 0 means success. A negative value means error: VI did not execute the intended operation. A positive value means warning: VI executed intended operation, but an informational warning is returned. For a description of the **code**, wire the error cluster to a LabVIEW error-handling VI, such as the Simple Error Handler.



**source** identifies the VI where the error occurred.

## Description

This VI is intended to serve as an example. You can use the VI as is, but the LabVIEW diagram is commented so that you can use the VI as a starting point for more complex synchronization scenarios. Before you customize the LabVIEW diagram, save a copy of the VI for editing.



## CAN Clear Multiple with NI-DAQ.vi

### Purpose

Stop and clear the list of NI-CAN tasks and the NI-DAQ task synchronized with [CAN Sync Start Multiple with NI-DAQ.vi](#).

### Format

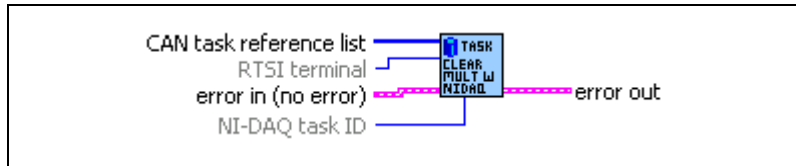

### Inputs



**CAN task reference list** is the same array of NI-CAN task references you wired into the [CAN Sync Start Multiple with NI-DAQ VI](#).



If you wire the same **RTSI terminal** that you passed into [CAN Sync Start Multiple with NI-DAQ.vi](#), this VI clears the routing in NI-DAQ. If you leave **RTSI terminal** unwired, the VI retains the routing in NI-DAQ. This VI always clears RTSI routing for NI-CAN.



**NI-DAQ task ID** is NI-DAQ task ID you wired into the [CAN Sync Start Multiple with NI-DAQ VI](#).



**Error in** describes error conditions occurring before the VI executes. If an error has already occurred, the VI returns the value of the **Error in** cluster in **Error out**.



**status** is True if an error occurred. If **status** is True, the VI does not perform any operations.



**code** is the error code number identifying an error. A value of 0 means success. A negative value means error: VI did not execute the intended operation. A positive value means warning: VI executed intended operation, but an informational warning is returned. For a description of the **code**, wire the error cluster to a LabVIEW error-handling VI, such as the Simple Error Handler.



**source** identifies the VI where the error occurred.

## Outputs



**Error out** describes error conditions. If the **Error in** cluster indicated an error, the **Error out** cluster contains the same information. Otherwise, **Error out** describes the error status of this VI.



**status** is True if an error occurred.



**code** is the error code number identifying an error. A value of 0 means success. A negative value means error: VI did not execute the intended operation. A positive value means warning: VI executed intended operation, but an informational warning is returned. For a description of the **code**, wire the error cluster to a LabVIEW error-handling VI, such as the Simple Error Handler.



**source** identifies the VI where the error occurred.

## Description

All tasks are cleared to their state prior to [CAN Sync Start Multiple with NI-DAQ.vi](#). For example, this VI clears terminal routing of all NI-DAQ devices to the default state.

This VI is intended to serve as an example. You can use the VI as is, but the LabVIEW diagram is commented so you can use the VI as a starting point for more complex synchronization scenarios. Before you customize the LabVIEW diagram, save a copy of the VI for editing.

## CAN Clear Multiple with NI-DAQmx.vi

### Purpose

Stop and clear the list of NI-CAN tasks and the NI-DAQmx task synchronized with **CAN Sync Start with NI-DAQmx.vi**.

### Format

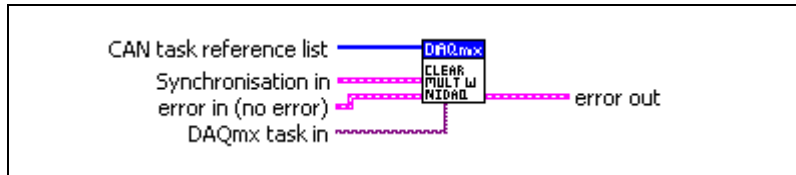

### Inputs



**CAN task reference list** is the same array of NI-CAN task references you wired into the **CAN Sync Start with NI-DAQmx.vi**.



**Synchronisation in** defines a cluster with information about the signals that have been routed between the cards and about additional DAQmx tasks that may have been created for synchronization. This information is needed to clear the routings in the NI-CAN and the NI-DAQmx devices after the measurement has been finished.



**Counter task in** is the task from an **NI-DAQmx Create Virtual Channel VI**. This additional NI-DAQmx task is created under certain circumstances to generate a common timebase clock for cards that do not support sharing of timebases through RTSI (like DAQ-Cards or NI-CAN Series 1 cards).



**Routes out** is a 1-dimensional array of terminal names of signals that have been routed between the cards.



**Source terminal** is the name of the terminal where the route starts.



**Destination terminal** is the name of the terminal where the route ends.



**NI-DAQ task in** is the same NI-DAQ task in you wired into the **CAN Sync Start Multiple with NI-DAQmx VI**.

## Outputs



**Error out** describes error conditions. If the **Error in** cluster indicated an error, the **Error out** cluster contains the same information. Otherwise, **Error out** describes the error status of this VI.



**status** is True if an error occurred.



**code** is the error code number identifying an error. A value of 0 means success. A negative value means error: VI did not execute the intended operation. A positive value means warning: VI executed intended operation, but an informational warning is returned. For a description of the **code**, wire the error cluster to a LabVIEW error-handling VI, such as the Simple Error Handler.



**source** identifies the VI where the error occurred.

## Description

All tasks are cleared to their state prior to **CAN Sync Start Multiple with NI-DAQ**. For example, this VI clears terminal routing of all NI-DAQ devices to the default state.

This VI is intended to serve as an example. You can use the VI as is, but the LabVIEW diagram is commented so you can use the VI as a starting point for more complex synchronization scenarios. Before you customize the LabVIEW diagram, save a copy of the VI for editing.

## CAN Connect Terminals.vi

### Purpose

Connect a terminal in the CAN hardware.

### Format

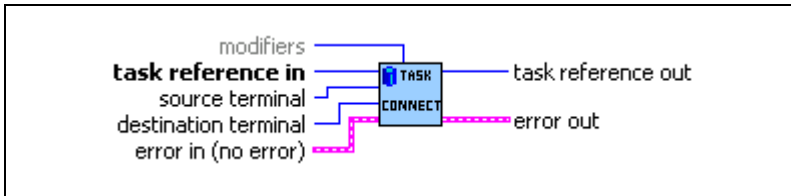

### Inputs



**task reference in** is the task reference from the previous NI-CAN VI. The task reference is originally returned from [CAN Init Start.vi](#), [CAN Initialize.vi](#), or [CAN Create Message.vi](#), and then wired through subsequent VIs.



**source terminal** specifies the source of the connection.

Once the connection is successfully created, behavior flows from **source terminal** to **destination terminal**.

For a list of valid source/destination pairs, refer to the [Valid Combinations of Source/Destination](#) section in this function reference.

The following list describes each value of **source terminal**:

#### RTSI0... RTSI6

Selects a general-purpose RTSI line as source (input) of the connection.

#### RTSI7/RTSI Clock

Selects RTSI line 7 as source (input) of the connection. **RTSI7** is dedicated for routing of a timebase (10 MHz or 20 MHz). **RTSI7** is also known as **RTSI Clock** in some National Instruments software products, such as NI-DAQ.

The only valid **destination terminal** for this source is **Master Timebase**.

For PCI and PXI form factors, this receives a 20 MHz (default) timebase from another CAN or DAQ card. For example, you can synchronize a CAN and DAQ E Series MIO card by connecting the 20 MHz oscillator (board clock) of the DAQ card to **RTSI7/RTSI Clock**, and then connecting **RTSI7/RTSI Clock** to **Master Timebase** on the CAN card.

For PCMCIA form factor, a 10 MHz timebase is required on **RTSI7/RTSI Clock**. For synchronization with a PCMCIA DAQ card, this is done by programming **FREQOUT** signal of the DAQ card to 10 MHz, then wiring **FREQOUT** to the **RTSI7/RTSI Clock** of the CAN card.

This value applies to Series 2 cards only (returns error for Series 1).

### PXI\_Star

**PXI\_Star** selects the PXI star trigger signal.

Within a PXI chassis, some PXI products can source star trigger from Slot 2 to all higher-numbered slots. **PXI\_Star** enables the PXI CAN card to receive the star trigger when it is in Slot 3 or higher.

This value applies to Series 2 PXI CAN cards only. If you are using a Series 1 CAN card or Series 2 PCI or PCMCIA CAN card, selecting this value results in an error.

### PXI\_Clk10

**PXI\_Clk10** selects the PXI 10 MHz backplane clock.

The only valid **destination terminal** for this source is **Master Timebase**. This routes the 10 MHz PXI backplane clock for use as the timebase of the CAN card. When you use **PXI\_Clk10** as the timebase for the CAN card, you must also use **PXI\_Clk10** as the timebase for other PXI cards to perform synchronized input/output.

This value applies to Series 2 PXI CAN cards only. If you are using a Series 1 CAN card or Series 2 PCI or PCMCIA CAN card, selecting this value results in an error.

### 20 MHz Timebase

**20 MHz Timebase** selects the local 20 MHz oscillator of the CAN card.

The only valid **destination terminal** for this source is **RTSI7/RTSI Clock**. This routes the local 20 MHz clock of the CAN card for use as a timebase by other NI cards. For example, you can synchronize two CAN cards by connecting **20 MHz Timebase** to **RTSI7/RTSI Clock** on one CAN card and then connecting **RTSI7/RTSI Clock** to **Master Timebase** on the other CAN card.

**20 MHz Timebase** applies to the entire CAN card, including both interfaces of a 2-port CAN card. The CAN card is specified by the task interface, such as the **interface** input to [CAN Initialize.vi](#).

This value applies to Series 2 PXI or PCI CAN cards only. If you are using a Series 1 CAN card or Series 2 PCMCIA CAN card, selecting this value results in an error.

### 10 Hz Resync Clock

**10 Hz Resync Clock** selects a 10 Hz, 50 percent duty cycle clock. This slow rate is required for resynchronization of Series 1 CAN cards. On each pulse of the resync clock, the other CAN card brings its clock into sync.

By selecting **RTSI0** to **RTSI6** as the **destination terminal**, you route the 10 Hz clock to synchronize with other Series 1 CAN cards. NI-DAQ cards cannot use the 10 Hz resync clock, so this selection is limited to synchronization of two or more CAN cards.

**10 Hz Resync Clock** applies to the entire CAN card, including both interfaces of a 2-port CAN card. The CAN card is specified by the task interface, such as the **interface** input to [CAN Initialize.vi](#).

This value is typically used with Series 1 CAN cards only. If all of the CAN cards are Series 2, the 20 MHz timebase is preferable due to the lack of drift. If you are using a mix of Series 1 and Series 2 CAN cards, you must use the **10 Hz Resync Clock**.

### Interface Receive Event

**Interface Receive Event** selects the dedicated receive interrupt output on the Philips SJA1000 CAN controller. When a received frame successfully passes the acceptance filter, a pulse with the width of one bit time is output during the last bit of the end of frame position of the CAN frame. Incoming CAN frames can be filtered using the **Series 2 Filter Mode** property.

The CAN controller is specified by the task interface, such as the **interface** input to [CAN Initialize.vi](#).

The **Interface Receive Event** can be used as the start trigger for other NI cards, or for external instruments.

Since this value requires the Philips SJA1000 CAN controller, it applies to Series 2 CAN cards only. If you are using a Series 1 CAN card, selecting this value results in an error.

### Interface Transceiver Event

**Interface Transceiver Event** selects the NERR signal from the CAN transceiver. The Low-Speed/Fault-Tolerant transceiver and the High-Speed transceiver provide the NERR signal. This signal asserts when the transceiver detects a fault. The default value of NERR is logic-high, which indicates no error.

The CAN controller is specified by the task interface, such as the **interface** input to [CAN Initialize.vi](#).

This value applies to Series 2 CAN cards only. If you are using a Series 1 CAN card, selecting this value results in an error.

### Start Trigger

**Start Trigger** selects the start trigger, the event that begins sampling for tasks.

The start trigger is the same for all tasks using a given interface, such as the **interface** input to [CAN Initialize.vi](#).

In the default (disconnected) state of the **Start Trigger** destination, the start trigger occurs when communication begins on the interface.

By selecting **RTSI0** to **RTSI6** as the **destination terminal**, you route the start trigger of this CAN card to the start trigger of other CAN or DAQ cards. This ensures that sampling begins at the same time on both cards. For example, you can synchronize two CAN cards by routing **Start Trigger** as the **source terminal** on one CAN card and then routing **Start Trigger** as the **destination terminal** on the other CAN card, with both cards using the same RTSI line for the connections.





**destination terminal** specifies the destination of the connection. The following list describes each value of **destination terminal**:

#### **RTSI0... RTSI6**

Selects a general-purpose RTSI line as destination (output) of the connection.

#### **RTSI7/RTSI Clock**

Selects RTSI line 7 as destination (output) of the connection. **RTSI7** is dedicated for routing of a timebase. **RTSI7** is also known as **RTSI Clock** in some National Instruments software products, such as NI-DAQ. The only valid source terminal for this source is **20 MHz Timebase**. The CAN card can import a 10 MHz or 20 MHz timebase, but can export only a 20 MHz timebase.

This value applies to Series 2 CAN cards only. If you are using a Series 1 CAN card, selecting this value results in an error.

#### **Master Timebase**

**Master Timebase** instructs the CAN card to use the source of the connection as the master timebase. The CAN card uses this master timebase for input sampling (including timestamps of received messages) as well as periodic output sampling.

For PCI and PXI form factors, you can use **RTSI7/RTSI Clock** as the **source terminal**. By default, this receives a 20 MHz timebase from another CAN or DAQ card. For example, you can synchronize a CAN and DAQ E Series MIO card by connecting the 20 MHz oscillator (board clock) of the DAQ card to **RTSI7/RTSI Clock**, and then connecting **RTSI7/RTSI Clock** to **Master Timebase** on the CAN card. To change the **Master Timebase Rate** to 10 MHz, use [CAN Set Property.vi](#) to change the Hardware **Master Timebase Rate**.

For PXI form factor, you also can use **PXI\_Clk10** as the **source terminal**. This receives the PXI 10 MHz backplane clock for use as the master timebase.

For PCMCIA form factor, you can use **RTSI7/RTSI Clock** as the **source terminal**. Unlike PCI and PXI, the PCMCIA CAN card requires a 10 MHz timebase on **RTSI7/RTSI Clock**. For synchronization with a PCMCIA DAQ card, this is done by programming the **FREQOUT** signal of the DAQ card to 10 MHz,

then wiring **FREQOUT** to the **RTSI7/RTSI Clock** of the CAN card.

**Master Timebase** applies to the entire CAN card, including both interfaces of a 2-port CAN card. The CAN card is specified by the task interface, such as the **interface** input to [CAN Initialize.vi](#).

The default (disconnected) state of this destination means the CAN card uses its local 20 MHz timebase as the master timebase.

This value applies to Series 2 CAN cards only. If you are using a Series 1 CAN card, selecting this value results in an error.

### 10 Hz Resync Clock

**10 Hz Resync Clock** instructs the CAN card to use a 10 Hz, 50 percent duty cycle clock to resynchronize its local timebase. This slow rate is required for resynchronization of CAN cards. On each low-to-high transition of the resync clock, this CAN card brings its local timebase into sync.

When synchronizing to an E Series MIO card, a typical use of this value is to use **RTSI0** to **RTSI6** as the **source terminal**, then use NI-DAQ functions to program the Counter 0 of the MIO card to generate a 10 Hz 50 percent duty cycle clock on the RTSI line. For an example, refer to [CAN Sync Start with NI-DAQ.vi](#).

When synchronizing to a CAN card, a typical use of this value is to use **RTSI0** to **RTSI6** as the **source terminal**, then route the **10 Hz Resync Clock** of the other CAN card as the **source terminal** to the same RTSI line.

**10 Hz Resync Clock** applies to the entire CAN card, including both interfaces of a 2-port CAN card. The CAN card is specified by the task interface, such as the **interface** input to [CAN Initialize.vi](#).

The default (disconnected) state of this destination means the CAN card does not resynchronize its local timebase.

This value is typically used with Series 1 CAN cards only. If all of the CAN cards are Series 2, the 20 MHz timebase is preferable due to the lack of drift. If you are using a mix of Series 1 and Series 2 CAN cards, you must use the **10 Hz Resync Clock**.

## Start Trigger

Start Trigger selects the start trigger, the event that begins sampling for tasks. The start trigger occurs on the first low-to-high transition of the source terminal.

The start trigger is the same for all tasks using a given interface, such as the **interface** input to [CAN Initialize.vi](#).

By selecting **RTSI0** to **RTSI6**, or **PXI\_Star** for PXI hardware, as the **source terminal**, you route the start trigger from another CAN or DAQ card. This ensures that sampling begins at the same time on both cards. For example, you can synchronize with an E Series DAQ MIO card by routing the AI start trigger of the MIO card to a RTSI line and then routing the same RTSI line with **Start Trigger** as the **destination terminal** on the CAN card.

The default (disconnected) state of this destination means the start trigger occurs when communication begins on the interface. Because communication begins when the first interface task is started, this does not synchronize sampling with other NI cards.



**modifiers** provides optional connection information for certain source/destination pairs. The current release of NI-CAN does not use this information for any source/destination pair, so **modifiers** must be left unwired.



**Error in** describes error conditions occurring before the VI executes. If an error has already occurred, the VI returns the value of the **Error in** cluster in **Error out**.



**status** is True if an error occurred. If **status** is True, the VI does not perform any operations.



**code** is the error code number identifying an error. A value of 0 means success. A negative value means error: VI did not execute the intended operation. A positive value means warning: VI executed intended operation, but an informational warning is returned. For a description of the **code**, wire the error cluster to a LabVIEW error-handling VI, such as the Simple Error Handler.



**source** identifies the VI where the error occurred.

## Outputs



**task reference out** is the same as **task reference in**. Wire the task reference to subsequent VIs for this task.



**Error out** describes error conditions. If the **Error in** cluster indicated an error, the **Error out** cluster contains the same information. Otherwise, **Error out** describes the error status of this VI.



**status** is True if an error occurred.



**code** is the error code number identifying an error. A value of 0 means success. A negative value means error: VI did not execute the intended operation. A positive value means warning: VI executed intended operation, but an informational warning is returned. For a description of the **code**, wire the error cluster to a LabVIEW error-handling VI, such as the Simple Error Handler.



**source** identifies the VI where the error occurred.

## Description

This VI connects a specific pair of source/destination terminals. One of the terminals is typically a RTSI signal, and the other terminal is an internal terminal in the CAN hardware. By connecting internal terminals to RTSI, you can synchronize the CAN card with another hardware product such as an NI-DAQ card.

The most common uses of RTSI synchronization are demonstrated by [CAN Sync Start with NI-DAQ.vi](#), [CAN Sync Start with NI-DAQmx.vi](#), [CAN Sync Start Multiple with NI-DAQ.vi](#), and [CAN Sync Start Multiple with NI-DAQmx.vi](#). The diagram for each of these example VIs uses CAN Connect Terminals, and therefore serves as a good starting point when learning this VI.

When the final task for a given interface is cleared with [CAN Clear.vi](#), NI-CAN disconnects all terminal connections for that interface. Therefore, [CAN Disconnect Terminals.vi](#) is not required for most applications. NI-DAQ terminals remain connected after the tasks are cleared, so you must disconnect NI-DAQ terminals manually at the end of the application.

For a list of valid source/destination pairs, refer to the following section.

## Valid Combinations of Source/Destination

Table 7-2, [Valid Combinations of Source/Destination](#), lists all valid combinations of **source terminal** and **destination terminal**.

The series of the NI CAN hardware determines what combinations of **source terminal** to **destination terminal** are valid. In Table 7-2, 1 indicates Series 1 hardware, and 2 indicates

Series 2 hardware. You can determine the series of the NI CAN hardware by selecting the name of the card within the **Devices and Interfaces»NI-CAN Devices** view in the left pane of MAX.

Series 1 hardware has the following limitations.

- PXI cards do not support **RTSI6**.
- Signals received from a RTSI source cannot occur faster than 1 kHz. This prevents the card from receiving a 10 MHz or 20 MHz timebase, such as NI E Series MIO hardware provides.
- Signals received from a RTSI source must be at least 100  $\mu$ s in length to be detected. This prevents the card from receiving triggers in the nanoseconds range, such as the AI trigger that E Series MIO hardware provides. Series 2 CAN cards also send RTSI pulses in the nanoseconds range, so Series 1 CAN cards cannot receive RTSI input from Series 2 CAN cards.
- For CAN cards with High-Speed (HS) ports only, four RTSI signals are available for input (source), and four RTSI signals are available for output (destination). This limitation applies to the number of signals per direction, not the RTSI signal number. For example, if you connect **RTSI0**, **RTSI1**, **RTSI3**, and **RTSI5** as input, connecting **RTSI4** as input will return an error.
- For CAN cards with one or more Low-Speed (LS) ports, two RTSI signals are available for input (source), and three RTSI signals are available for output (destination).

Series 2 hardware has the following limitations.

- For all form factors (PCI, PXI, PCMCIA), the connection of **Interface Transceiver Event** to a RTSI destination depends on the physical port location. If the interface is on Port 1, you can connect to only even-numbered RTSI lines (**RTSI0**, **RTSI2**, **RTSI4**, **RTSI6**). If the interface is on Port 2, you can connect to only odd-numbered RTSI lines (**RTSI1**, **RTSI3**, **RTSI5**). You can determine the location by selecting the name of the interface in MAX.
- PCI cards do not support the **PXI\_Star** and **PXI\_Clk10** terminals, as those signals exist on the PXI backplane.
- PCMCIA cards do not support the **20 MHz Timebase**, **PXI\_Star**, and **PXI\_Clk10** terminals. Because **20 MHz Timebase** is not supported, you cannot synchronize the timebases of two PCMCIA CAN cards.
- On PCMCIA cards, **RTSI4**, **RTSI5** and **RTSI6** are not available.

**Table 7-2.** Valid Combinations of Source/Destination

Source	Destination				
	RTSI0 to RTSI6	RTSI_CLO CK	Master Timebase	10 Hz Resync Clock	Start Trigger
RTSI0 to RTSI6	—	—	—	1,2	1,2
RTSI7/RTSI Clock	—	—	2	—	—
PXI_Star	—	—	—	—	2
PXI_Clk10	—	—	2	—	—
20 MHz Timebase	—	2	—	—	—
10 Hz Resync Clock	1,2	—	—	—	1,2
Interface Receive Event	2	—	—	—	2
Interface Transceiver Event	2	—	—	—	—
Start Trigger Event	1,2	—	—	—	—

1—Valid connection for Series 1 hardware

2—Valid connection for Series 2 hardware

## CAN Create Message.vi

### Purpose

Create a message configuration and associated channel configurations within the LabVIEW application.

### Format

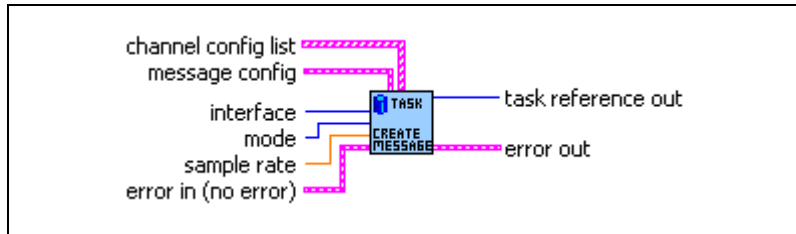

### Inputs



**interface** specifies the CAN interface to use for this task.

The interface input uses a ring typedef in which value 0 selects **CAN0**, value 1 selects **CAN1**, and so on. The **interface** input is required. Since the messages and channels are not defined in MAX, you cannot use **MAX default** as the **interface**.

The default baud rate for the **interface** is defined within MAX, but you can change it by setting the **Interface Baud Rate** property with [CAN Set Property.vi](#).

The special interface values 256 and 257 refer to virtual interfaces. For more information on usage of virtual interfaces, refer to the [Frame to Channel Conversion](#) section of Chapter 6, [Using the Channel API](#).



**mode** specifies the I/O mode for the task. For an overview of the I/O modes, including figures, refer to the [Channel API Basic Programming Model](#) section of Chapter 6, [Using the Channel API](#).

### Input

Input channel data from received CAN messages. Use [CAN Read.vi](#) to obtain input samples as single point, array, or waveform.

Use this input mode to read waveforms of timed samples, such as for comparison with NI-DAQ waveforms. You also can use this input

mode to read a single point from the most recent message, such as for control or simulation.

### Output

Output channel data to CAN messages for transmit. Use [CAN Write.vi](#) to write output samples as single-point, array, or waveform. Each sample value that you write is transmitted in a message on the network. If you write an array or waveform, the samples are buffered for subsequent transmit.

### Output Recent

Output channel data to CAN messages for transmit. This mode is used with sample rate greater than zero (periodic transmit). Use [CAN Write.vi](#) to provide a single sample per channel. Each periodic message uses the sample values from the most recent [CAN Write.vi](#). For this mode, there are restrictions on using channels in channel list that are contained in multiple messages. Refer to [CAN Read.vi](#) for more information.

### Timestamped Input

Input channel data from received CAN messages. Use [CAN Read.vi](#) to obtain input samples as an array of sample/timestamp pairs (Poly VI types ending in *Timestamped Dbt*).

Use this input mode to read samples with timestamps that indicate when each message is received from the network.



**sample rate** specifies the timing to use for samples of the task. The sample rate is specified in Hertz (samples per second). A sample rate of zero means to sample immediately.

For **mode** of **Input**, a **sample rate** of zero means that [CAN Read.vi](#) returns a single point from the most recent message received, and greater than zero means that [CAN Read.vi](#) returns samples timed at the specified rate.

For **mode** of **Output**, a **sample rate** of zero means that CAN messages transmit immediately when [CAN Write.vi](#) is called, and greater than zero means that CAN messages are transmitted periodically at the specified rate.

For **mode** of **Timestamped Input**, **sample rate** is ignored.

When the **interface** specifies a virtual interface (256 or 257), and **mode** is **Output** or **Output Recent**, this **sample rate** must be zero (greater than zero not supported).





**message config** configures properties for a new message. These properties are similar to the message properties in MAX. **Can Create Message.vi** creates a task for a single message with one or more channels.



#### message ID

Configures the arbitration ID of the message.

Use the **extended ID?** Boolean to specify whether the ID is standard (11-bit) or extended (29-bit).



#### extended ID?

Configures a Boolean value that indicates whether the arbitration ID of the message is standard 11-bit format (false) or extended 29-bit format (true).



#### number of bytes

Configures the number of data bytes in the message. The range is 1 to 8.



**channel config list** configures a list of channels for the new message. The **channel config list** is an array of clusters, with one cluster for each channel. The properties of each channel entry are similar to the channel properties in MAX:



#### start bit

Configures the starting bit position in the message. The range is 0 (lowest bit in first byte) to 63 (highest bit in last byte).



#### number of bits

Configures the number of bits for the raw data in the message. The range is 1 to 64.



#### byte order

Configures the byte order of the channel in the message.

The value of **byte order** is an enumeration:

- |   |          |  |
|---|----------|--|
| 0 | Intel    | Bytes are in little-endian order, with most-significant first. |
| 1 | Motorola | Bytes are in big-endian order, with least-significant first.   |

**data type**

Configures the data type of the channel in the message.

The value of **Channel Data Type** is an enumeration:

- |   |            |   |
|---|------------|---|
| 0 | Signed     | Raw data in the message is a signed integer.                    |
| 1 | Unsigned   | Raw data in the message is an unsigned integer.                 |
| 2 | IEEE Float | Raw data in the message is floating-point; no scaling required. |

**scaling factor**

Configures the scaling factor used to convert raw data in the message to/from scaled floating-point units. The scaling factor is the  $A$  in the linear scaling formula  $AX+B$ , where  $X$  is the raw data, and  $B$  is the scaling offset.

**scaling offset**

Configures the scaling offset used to convert raw data in the message to/from scaled floating-point units. The scaling offset is the  $B$  in the linear scaling formula  $AX+B$ , where  $X$  is the raw data, and  $A$  is the scaling factor.

**min value**

Configures the minimum value of the channel in scaled floating-point units.

The **CAN Read.vi** and **CAN Write.vi** VIs do not coerce samples when converting to/from CAN messages. You can use this value with property nodes to set the range of front-panel controls and indicators.

**max value**

Configures the maximum value of the channel in scaled floating-point units.

The **CAN Read.vi** and **CAN Write.vi** VIs do not coerce samples when converting to/from CAN messages. You can use this value with property nodes to set the range of front-panel controls and indicators.



**default value**

Configures the default value of the channel in scaled floating-point units.

For information on how the **default value** is used, refer to [CAN Read.vi](#) and [CAN Write.vi](#).



**unit string**

Configures the channel unit string. The string is no more than 64 characters in length.

You can use this value to display units (such as volts or RPM) along with the samples of the channel.



**Error in** describes error conditions occurring before the VI executes. If an error has already occurred, the VI returns the value of the **Error in** cluster in **Error out**.



**status** is True if an error occurred. If **status** is True, the VI does not perform any operations.



**code** is the error code number identifying an error. A value of 0 means success. A negative value means error: VI did not execute the intended operation. A positive value means warning: VI executed intended operation, but an informational warning is returned. For a description of the **code**, wire the error cluster to a LabVIEW error-handling VI, such as the Simple Error Handler.

**Outputs**



Use **task reference out** with all subsequent VIs to reference the task. Wire this task reference to [CAN Start.vi](#) before you read or write samples for the message.



**Error out** describes error conditions. If the **Error in** cluster indicated an error, the **Error out** cluster contains the same information. Otherwise, **Error out** describes the error status of this VI.



**status** is True if an error occurred.



**code** is the error code number identifying an error. A value of 0 means success. A negative value means error: VI did not execute the intended operation. A positive value means warning: VI executed intended operation, but an informational warning is returned. For a description of the **code**, wire the error cluster to a LabVIEW error-handling VI, such as the Simple Error Handler.



**source** identifies the VI where the error occurred.

## Description

To use message and channel configurations from MAX or a CAN database, use **CAN Init Start.vi** or **CAN Initialize.vi**. The **CAN Create Message** provides an alternative in which you create the message and channel configurations within the application, without use of MAX or a CAN database.

**CAN Create Message** returns a task reference that you wire to **CAN Start.vi** to start communication for the message and its channels.

## CAN Create MessageEx.vi

### Purpose

Create a message configuration and associated channel configurations within the application.

### Format

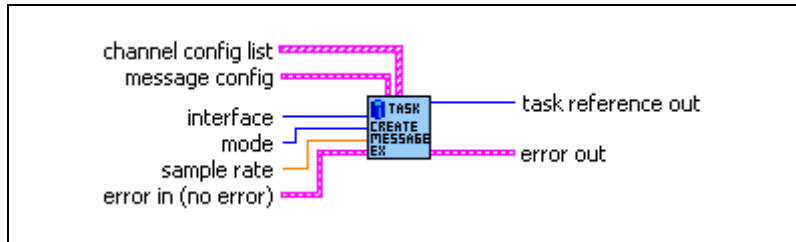

### Inputs



**interface** specifies the CAN interface to use for this task.

The interface input uses a ring typedef in which value 0 selects **CAN0**, value 1 selects **CAN1**, and so on.

The **interface** input is required. Since the messages and channels are not defined in MAX, you cannot use **MAX default** as the **interface**.

The default baud rate for the **interface** is defined within MAX, but you can change it by setting the **Interface Baud Rate** property with [CAN Set Property.vi](#).

The special interface values 256 and 257 refer to virtual interfaces. For more information on usage of virtual interfaces, refer to the [Frame to Channel Conversion](#) section of Chapter 6, [Using the Channel API](#).



**mode** specifies the I/O mode for the task. For an overview of the I/O modes, including figures, refer to the [Channel API Basic Programming Model](#) section of Chapter 6, [Using the Channel API](#).

#### Input

Input channel data from received CAN messages. Use [CAN Read.vi](#) to obtain input samples as single point, array, or waveform.

Use this input mode to read waveforms of timed samples, such as for comparison with NI-DAQ waveforms. You also can use this input mode to

read a single point from the most recent message, such as for control or simulation.

### Output

Output channel data to CAN messages for transmit. Use [CAN Write.vi](#) to write output samples as single-point, array, or waveform. Each sample value that you write is transmitted in a message on the network. If you write an array or waveform, the samples are buffered for subsequent transmit.

### Output Recent

Output channel data to CAN messages for transmit. This mode is used with sample rate greater than zero (periodic transmit). Use [CAN Write.vi](#) to provide a single sample per channel. Each periodic message uses the sample values from the most recent [CAN Write.vi](#).

For this mode, there are restrictions on using channels in channel list that are contained in multiple messages. Refer to [CAN Read.vi](#) for more information.

### Timestamped Input

Input channel data from received CAN messages. Use [CAN Read.vi](#) to obtain input samples as an array of sample/timestamp pairs (Poly VI types ending in *Timestamped Dbt*).

Use this input mode to read samples with timestamps that indicate when each message is received from the network.



**sample rate** specifies the timing to use for samples of the task. The sample rate is specified in Hertz (samples per second). A sample rate of zero means to sample immediately.

For **mode of Input**, a **sample rate** of zero means that [CAN Read.vi](#) returns a single point from the most recent message received, and greater than zero means that [CAN Read.vi](#) returns samples timed at the specified rate.

For **mode of Output**, a **sample rate** of zero means that CAN messages transmit immediately when [CAN Write.vi](#) is called, and greater than zero means that CAN messages are transmitted periodically at the specified rate.

For **mode of Timestamped Input**, **sample rate** is ignored.

When the **interface** specifies a virtual interface (256 or 257), and **mode** is **Output** or **Output Recent**, this **sample rate** must be zero (greater than zero not supported).



**message config** configures properties for a new message. These properties are similar to the message properties in MAX. **Can Create Message.vi** creates a task for a single message with one or more channels.



#### message ID

Configures the arbitration ID of the message.

Use the **extended ID?** Boolean to specify whether the ID is standard (11-bit) or extended (29-bit).



#### extended ID?

Configures a Boolean value that indicates whether the arbitration ID of the message is standard 11-bit format (false) or extended 29-bit format (true).



#### number of bytes

Configures the number of data bytes in the message. The range is 1 to 8.



**channel config list** configures a list of channels for the new message. The **channel config list** is an array of clusters, with one cluster for each channel. The properties of each channel entry are similar to the channel properties in MAX:



#### start bit

Configures the starting bit position in the message. The range is 0 (lowest bit in first byte) to 63 (highest bit in last byte).



#### number of bits

Configures the number of bits for the raw data in the message. The range is 1 to 64.



#### byte order

Configures the byte order of the channel in the message.

The value of **byte order** is an enumeration:

- |   |          |  |
|---|----------|--|
| 0 | Intel    | Bytes are in little-endian order, with most-significant first. |
| 1 | Motorola | Bytes are in big-endian order, with least-significant first.   |

**data type**

Configures the data type of channel in the message.

- |   |               |   |
|---|---------------|---|
| 0 | Signed        | Raw data in the message is a signed integer.                    |
| 1 | Unsigned      | Raw data in the message is an unsigned integer.                 |
| 2 | IEEE<br>Float | Raw data in the message is floating-point; no scaling required. |

**scaling factor**

Configures the scaling factor used to convert raw data in the message to/from scaled floating-point units. The scaling factor is the  $A$  in the linear scaling formula  $AX+B$ , where  $X$  is the raw data, and  $B$  is the scaling offset.

**scaling offset**

Configures the scaling offset used to convert raw data in the message to/from scaled floating-point units. The scaling offset is the  $B$  in the linear scaling formula  $AX+B$ , where  $X$  is the raw data, and  $A$  is the scaling factor.

**min value**

Configures the minimum value of the channel in scaled floating-point units.

The [CAN Read.vi](#) and [CAN Write.vi](#) VIs do not coerce samples when converting to/from CAN messages. You can use this value with property nodes to set the range of front-panel controls and indicators.

**max value**

Configures the maximum value of the channel in scaled floating-point units.

The [CAN Read.vi](#) and [CAN Write.vi](#) VIs do not coerce samples when converting to/from CAN messages. You can use this value with property nodes to set the range of front-panel controls and indicators.





**default value**

Configures the default value of the channel in scaled floating-point units.

For information on how the **default value** is used, refer to [CAN Read.vi](#) and [CAN Write.vi](#).



**unit string**

Configures the channel unit string. The string is no more than 64 characters in length.

You can use this value to display units (such as volts or RPM) along with the samples on a channel.



**Mode channel config** configures a list of the mode channels for this (data) channel. Currently, only one mode channel is allowed per (data) channel. Note that the same mode channel can be specified for several channels.



**Mode value**

Configures the mode channel value for which the data channel is valid.



**Start Bit**

Configures the starting bit position in the message. The range is 0 (lowest bit in first byte) to 63 (highest bit in last byte).



**Num Bits**

Configures the number of bits for the raw data in the message. The range is 1 to 64.



**byte order**

Configures the byte order of a channel in the message.

The value of **byte order** is an enumeration:

- 0 Intel Bytes are in little-endian order, with most-significant first.
- 1 Motorola Bytes are in big-endian order, with least-significant first.



## Default Value

This field is reserved. Set it to 0.



**Error in** describes error conditions occurring before the VI executes. If an error has already occurred, the VI returns the value of the **Error in** cluster in **Error out**.



**status** is True if an error occurred. If **status** is True, the VI does not perform any operations.



**code** is the error code number identifying an error. A value of 0 means success. A negative value means error: VI did not execute the intended operation. A positive value means warning: VI executed intended operation, but an informational warning is returned. For a description of the **code**, wire the error cluster to a LabVIEW error-handling VI, such as the Simple Error Handler.

## Outputs



Use **task reference out** with all subsequent VIs to reference the task. Wire this task reference to **CAN Start.vi** before you read or write samples for the message.



**Error out** describes error conditions. If the **Error in** cluster indicated an error, the **Error out** cluster contains the same information. Otherwise, **Error out** describes the error status of this VI.



**status** is True if an error occurred.



**code** is the error code number identifying an error. A value of 0 means success. A negative value means error: VI did not execute the intended operation. A positive value means warning: VI executed intended operation, but an informational warning is returned. For a description of the **code**, wire the error cluster to a LabVIEW error-handling VI, such as the Simple Error Handler.



**source** identifies the VI where the error occurred.

## Description

To use message and channel configurations from MAX or a CAN database, use the `nctInitStart` or `nctInitialize`. **CAN Create MessageEx** provides an alternative in which you create the message and channel configurations within the application, without use of MAX or a CAN database. In addition, **CAN Create MessageEx** offers optionally the possibility to specify mode dependent messages without using MAX or CAN databases.

**CAN Create MessageEx** returns a task reference that you wire to **CAN Start.vi** to start communication for the message and its channels.

## CAN Disconnect Terminals.vi

### Purpose

Disconnect terminals in the CAN hardware.

### Format

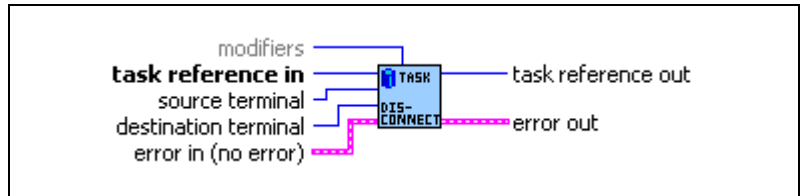

### Inputs



**task reference in** is the task reference from the previous NI-CAN VI. The task reference is originally returned from [CAN Init Start.vi](#), [CAN Initialize.vi](#), or [CAN Create Message.vi](#) and then wired through subsequent VIs.



**source terminal** specifies the connection source. For a description of values for **source terminal**, refer to [CAN Connect Terminals.vi](#).



**destination terminal** specifies the connection destination.

For a description of values for **destination terminal**, refer to [CAN Connect Terminals.vi](#).



**modifiers** provides optional connection information for certain source/destination pairs. The current release of NI-CAN does not use this information for any source/destination pair, so **modifiers** must be left unwired.



**Error in** describes error conditions occurring before the VI executes. If an error has already occurred, the VI returns the value of the **Error in** cluster in **Error out**.



**status** is True if an error occurred. If **status** is True, the VI does not perform any operations.



**code** is the error code number identifying an error. A value of 0 means success. A negative value means error: VI did not execute the intended operation. A positive value means warning: VI executed intended operation, but an informational warning is

returned. For a description of the **code**, wire the error cluster to a LabVIEW error-handling VI, such as the Simple Error Handler.



**source** identifies the VI where the error occurred.

## Outputs



**task reference out** is the same as **task reference in**. Wire the task reference to subsequent VIs for this task.



**Error out** describes error conditions. If the **Error in** cluster indicated an error, the **Error out** cluster contains the same information. Otherwise, **Error out** describes the error status of this VI.



**status** is True if an error occurred.



**code** is the error code number identifying an error. A value of 0 means success. A negative value means error: VI did not execute the intended operation. A positive value means warning: VI executed intended operation, but an informational warning is returned. For a description of the **code**, wire the error cluster to a LabVIEW error-handling VI, such as the Simple Error Handler.



**source** identifies the VI where the error occurred.

## Description

This VI disconnects a specific pair of source/destination terminals that were previously connected with **CAN Connect Terminals.vi**.

When the final task for a given interface is cleared with **CAN Clear.vi**, NI-CAN disconnects all terminal connections for that interface. Therefore, the **CAN Disconnect Terminals** VI is not required for most applications. This VI is typically used to change RTSI connections dynamically while an application is running. First, use **CAN Stop.vi** to stop all tasks for the interface, then use **CAN Disconnect Terminals** and **CAN Connect Terminals** to adjust RTSI connections, then **CAN Start.vi** to restart sampling.

## CAN Get Names.vi

### Purpose

Get an array of CAN channel names or message names from MAX or a CAN database file.

### Format

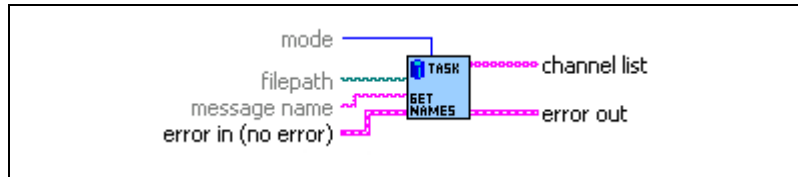

### Inputs



**filepath** is an optional path to a CAN database file from which to get channel names. The file must use either a `.DBC` or `.NCD` extension. Files with extension `.DBC` use the CANdb database format. Files with extension `.NCD` use the NI-CAN database format. You can generate NI-CAN database files from the **Save Channels** selection in MAX.

The default (unwired) value of **filepath** is empty, which means to get the channel names from MAX. The MAX CAN channels are in the MAX CAN channels listing within **Data Neighborhood**.



**message name** is an optional input that filters the names for a specific message. The default (unwired) value is an empty string, which means to return all names in the database. If you wire a nonempty string, the **channel list** output is limited to channels of the specified message. This input applies to **mode** of **channels** only. It is ignored for **mode** of **messages**.



**mode** is an optional input that specifies the type of names to return.

The value of **mode** is an enumeration:

- |   |          |   |
|---|----------|---|
| 0 | channels | Return list of channel names. You can write this list to <a href="#">CAN Init Start.vi</a> . This is the default value. |
| 1 | messages | Return list of message names.   |



**Error in** describes error conditions occurring before the VI executes. If an error has already occurred, the VI returns the value of the **Error in** cluster in **Error out**.



**status** is True if an error occurred. If **status** is True, the VI does not perform any operations.



**code** is the error code number identifying an error. A value of 0 means success. A negative value means error: VI did not execute the intended operation. A positive value means warning: VI executed intended operation, but an informational warning is returned. For a description of the **code**, wire the error cluster to a LabVIEW error-handling VI, such as the Simple Error Handler.



**source** identifies the VI where the error occurred.

## Outputs



**channel list** returns the array of channel names, one string entry per channel.

The names in **channel list** use the minimum syntax required to properly initialize the channels:

- If a channel name is used within only one message in the database, **CAN Get Names** returns only the channel name in the array.
- If a channel name is used within multiple messages, **CAN Get Names** prepends the message name to that channel name, with a decimal point separating the message and channel name. This syntax ensures that the duplicate channel is associated to a single message in the database.

For more information on the syntax conventions for channel names, refer to [CAN Init Start.vi](#).

To start a task for all channels returned from **CAN Get Names**, wire **channel list** to [CAN Init Start.vi](#) to start a task.

You also can wire **channel list** to the property nodes of a front panel control such as a ring or list box. The user of the VI can then select names using this control, and the selected names can be wired to [CAN Init Start.vi](#).



**Error out** describes error conditions. If the **Error in** cluster indicated an error, the **Error out** cluster contains the same information. Otherwise, **Error out** describes the error status of this VI.



**status** is True if an error occurred.



**code** is the error code number identifying an error. A value of 0 means success. A negative value means error: VI did not execute the intended operation. A positive value means warning: VI executed intended operation, but an informational warning is

returned. For a description of the **code**, wire the error cluster to a LabVIEW error-handling VI, such as the Simple Error Handler.



**source** identifies the VI where the error occurred.



## CAN Get Property.vi

### Purpose

Get a property for the task, or a single channel within the task. The poly VI selection determines the property to get.

To select the property, right-click the VI, go to **Select Type** and select the property by name. For LabVIEW 7.0 and later, you can right-click the VI and select **Visible Items»Poly VI Selector** to select the property from within the diagram.

### Format

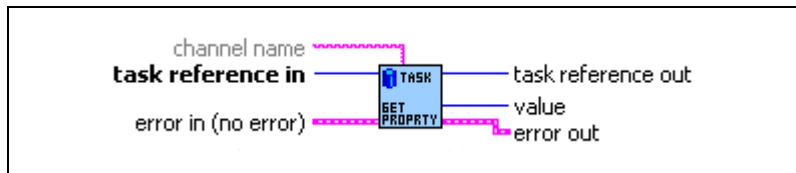

### Inputs



**task reference in** is the task reference from the previous NI-CAN VI. The task reference is originally returned from [CAN Init Start.vi](#), [CAN Initialize.vi](#), or [CAN Create Message.vi](#), and then wired through subsequent VIs.



**channel name** specifies an individual channel within the task. The default (unwired) value of channel name is empty, which means the property applies to the entire task, not a specific channel.

Properties that begin with the word *Channel* or *Message* do not apply to the entire task, but an individual channel or message within the task. For these channel-specific properties, you must wire the name of a channel from channel list into the **channel name** input.

For properties that do not begin with the word *Channel* or *Message*, you must leave **channel name** unwired (empty).



**Error in** describes error conditions occurring before the VI executes. If an error has already occurred, the VI returns the value of the **Error in** cluster in **Error out**.



**status** is True if an error occurred. If **status** is True, the VI does not perform any operations.



**code** is the error code number identifying an error. A value of 0 means success. A negative value means error: VI did not execute the intended operation. A positive value means warning: VI executed intended operation, but an informational warning is returned. For a description of the **code**, wire the error cluster to a LabVIEW error-handling VI, such as the Simple Error Handler.



**source** identifies the VI where the error occurred.

## Outputs



**task reference out** is the same as **task reference in**. Wire the task reference to subsequent VIs for this task.



The poly output **value** returns the property value. You select the property returned in **value** by selecting the Poly VI type. The data type of **value** is also determined by the Poly VI selection. For information about the different properties provided by [CAN Get Property.vi](#), refer to the *Poly VI Types* section in this function reference.

To select the property, right-click the VI, go to **Select Type** and select the property by name.



**Error out** describes error conditions. If the **Error in** cluster indicated an error, the **Error out** cluster contains the same information. Otherwise, **Error out** describes the error status of this VI.



**status** is True if an error occurred.



**code** is the error code number identifying an error. A value of 0 means success. A negative value means error: VI did not execute the intended operation. A positive value means warning: VI executed intended operation, but an informational warning is returned. For a description of the **code**, wire the error cluster to a LabVIEW error-handling VI, such as the Simple Error Handler.



**source** identifies the VI where the error occurred.

## Poly VI Types



### Behavior After Final Output

Returns the **Behavior After Final Output** property, which is used with some output task configurations. For more information, refer to the **Behavior After Final Output** property in [CAN Set Property.vi](#).



### Channel Byte Order

Returns the byte order of a channel in the message.

The value of **Channel Byte Order** is an enumeration:

- |   |          |  |
|---|----------|--|
| 0 | Intel    | Bytes are in little-endian order, with most-significant first. |
| 1 | Motorola | Bytes are in big-endian order, with least-significant first.   |

The value of this property cannot be changed using [CAN Set Property.vi](#).



### Channel Data Type

Returns the data type of a channel in the message.

The value of **Channel Data Type** is an enumeration:

- |   |               |   |
|---|---------------|---|
| 0 | Signed        | Raw data in the message is a signed integer.                    |
| 1 | Unsigned      | Raw data in the message is an unsigned integer.                 |
| 2 | IEEE<br>Float | Raw data in the message is floating-point; no scaling required. |

The value of this property cannot be changed using [CAN Set Property.vi](#).



### Channel Default Value

Returns the default value of the channel in scaled floating-point units.

For information on how **Channel Default Value** is used, refer to [CAN Read.vi](#) and [CAN Write.vi](#).

The value of this property is originally set within MAX or [CAN Create Message.vi](#). If the channel is initialized directly from a CAN database, the value is 0.0 by default, but it can be changed using [CAN Set Property.vi](#).



### Channel Maximum Value

Returns the maximum value of the channel in scaled floating-point units.

The [CAN Read.vi](#) and [CAN Write.vi](#) VIs do not coerce samples when converting to/from CAN messages. You can use this value with CAN database to set the range of front-panel controls and indicators.

The value of this property cannot be changed using [CAN Set Property.vi](#).



### Channel Minimum Value

Returns the minimum value of the channel in scaled floating-point units.

The **CAN Read.vi** and **CAN Write.vi** VIs do not coerce samples when converting to/from CAN messages. You can use this value with property nodes to set the range of front-panel controls and indicators.

The value of this property cannot be changed using **CAN Set Property.vi**.



### Channel Mode Value

Returns the value of the mode channel associated to this channel. This property applies only to mode dependent channels.



### Channel Number of Bits

Returns the number of bits in the message. The range is 1 to 64.

The value of this property cannot be changed using **CAN Set Property.vi**.



### Channel Scaling Factor

Returns the scaling factor used to convert raw bits of the message to/from scaled floating-point units. The scaling factor is the  $A$  in the linear scaling formula  $AX+B$ , where  $X$  is the raw data, and  $B$  is the scaling offset.

CAN messages use the raw data, and the **CAN Read.vi** and **CAN Write.vi** VIs provide access to samples in floating-point units.

The value of this property cannot be changed using **CAN Set Property.vi**.



### Channel Scaling Offset

Returns the scaling offset used to convert raw bits of the message to/from scaled floating-point units. The scaling offset is the  $B$  in the linear scaling formula  $AX+B$ , where  $X$  is the raw data, and  $A$  is the scaling factor.

CAN messages use the raw data, and the **CAN Read.vi** and **CAN Write.vi** VIs provide access to samples in floating-point units.

The value of this property cannot be changed using **CAN Set Property.vi**.



### Channel Start Bit

Returns the starting bit position in the message. The range is 0 (lowest bit in first byte) to 63 (highest bit in last byte).

The value of this property cannot be changed using **CAN Set Property.vi**.



### Channel Unit String

Returns the unit string of the channel. The string is no more than 80 characters in length.

You can use this value to display units (such as volts or RPM) along with the samples on a channel.

The value of this property cannot be changed using [CAN Set Property.vi](#).



### Hardware Form Factor

Returns the hardware form factor for the NI-CAN hardware that contains **interface**.

The value of **Hardware Form Factor** is an enumeration:

0	PCI
1	PXI
2	PCMCIA
3	AT



### Hardware Master Timebase Rate

Returns the present **Hardware Master Timebase Rate** in MHz, programmed into the CAN hardware. For PCMCIA, this property will always return 10 MHz.



### Hardware Serial Number

Returns the hardware serial number for the NI-CAN hardware that contains **interface**.



### Hardware Series

Returns the hardware series for the NI CAN hardware that contains Interface.

The value of **Hardware Series** is an enumeration:

0	Series 1	Series 1 hardware uses the Intel 82527 CAN controller.
1	Series 2	Series 2 hardware uses the Philips SJA1000 CAN controller and includes improved RTSI features.
4	NI-XNET	NI-XNET hardware visible through the NI-XNET Compatibility Library for NI-CAN.

Newer hardware series often have more features, so the application may need to determine which is installed.

**U32**

### Hardware Timestamp Format

Returns the present Timestamp Format programmed into the CAN hardware. This property applies to the entire card.

**U16**

### Interface

Returns the **interface** initialized for the task, such as with the **CAN Init Start VI**.

**U32**

### Interface Baud Rate

Returns the baud rate in use by the **interface**.

Basic baud rates such as 125000 and 500000 are specified as the numeric rate.

Advanced baud rates are specified as 8000XXYY hex, where YY is the value of Bit Timing Register 0 (BTR0), and XX is the value of Bit Timing Register 1 (BTR1) of the CAN controller chip. For more information, refer to the Interface Properties dialog in MAX.

The value of this property is originally set within MAX, but it can be changed using **CAN Set Property.vi**.

**TF**

### Interface Listen Only?

Returns a Boolean value that indicates whether the listen only feature of the Philips SJA1000 CAN controller is enabled (TRUE) or disabled (FALSE). For more information, refer to the Interface Listen Only? property in **CAN Set Property.vi**.

Since the listen only feature requires the Philips SJA1000 CAN controller, this property is supported on Series 2 NI CAN hardware only.

**U32**

### Interface Receive Error Counter

Returns the Receive Error Counter as described in the CAN specification.

Since the error counts require the Philips SJA1000 CAN controller, this property is supported on Series 2 NI CAN hardware only. If you are using Series 1 NI CAN hardware, this property returns an error.



### Interface Self Reception?

Returns the Interface Self Reception property as configured in [CAN Set Property.vi](#).

This property is supported on Series 2 NI CAN hardware only (returns error for Series 1).



### Interface Series 2 Error/Arb Capture

Returns the current values of the Error Code Capture register and Arbitration Lost Capture register from the Philips SJA1000 CAN controller chip.

The Error Code Capture register provides information on bus errors that occur according to the CAN standard. A bus error increments either the Interface Transmit Error Counter or the Interface Receive Error Counter. When communication starts on the interface, the first bus error is captured into the Error Code Capture register and retained until you get this property. After you get this property, the Error Code Capture register is again enabled to capture information for the next bus error.

The Arbitration Lost Capture register provides information on a loss of arbitration during transmit. Loss of arbitration is not considered an error. When communication starts on the interface, the first arbitration loss is captured into the Arbitration Lost Capture register, and retained until you get this property. After you get this property, the Arbitration Lost Capture register is again enabled to capture information for the next arbitration loss.

For each of the capture registers, a single-bit New flag indicates whether a new error has occurred since the last Get. If the New flag of a register is set, the associated fields contain new information. If the New flag of a register is clear, the associated fields are the same as the previous Get.

This property is commonly used with the Interface Single Shot Transmit property. When [CAN Write.vi](#) is used to transmit the single frame, you can get this property to determine if the transmit was successful. If the single shot transmit was not successful, this property provides detailed information for the failure.

This property is supported for Series 2 hardware only (not Series 1). Since the information and bit format is very specific to the Philips SJA1000 CAN controller on Series 2 hardware, National Instruments cannot guarantee compatibility for this property on future hardware series. When using this property in the application, it is best to get the Hardware Series to verify that the CAN hardware is Series 2.

For information regarding the format of the bits in this property, refer to **Series 2 Error/Arb Capture** attribute in the **ncGetAttr.vi** function of the Frame API.



### Interface Series 2 Comparator

Returns the value of the Interface Series 2 Comparator property (refer to **CAN Set Property.vi**).



### Interface Series 2 Filter Mode

Returns the value of the Interface Series 2 Filter Mode property (refer to **CAN Set Property.vi**).



### Interface Series 2 Mask

Returns the value of the Interface Series 2 Mask property (refer to **CAN Set Property.vi**).



### Interface Single Shot Transmit?

Returns the value of the Interface Single Shot Transmit property (refer to **CAN Set Property.vi**). The single-shot transmit feature is not available on the Intel 82527 CAN controller used by Series 1 CAN hardware (Get returns error).



### Interface Transceiver External Inputs

Returns the transceiver external inputs for the interface that was initialized for the task.

Series 2 XS cards enable connection of an external transceiver. For an external transceiver, this property allows you to determine the input voltage on the STATUS pin of the CAN port.

For many models of CAN transceiver, an NERR pin is provided for detection of faults and other status. For such transceivers, you can wire the NERR pin to the STATUS pin of the CAN port.

This property is supported for Series 2 XS cards only.

This property uses a bit mask. When using the property, use bitwise AND operations to check for values, not equality checks (equal, greater than, and so on).

00000001 hex STATUS

This bit is set when 5 V exists on the STATUS pin.

This bit is clear when 0 V exists on the STATUS pin.





### Interface Transceiver External Outputs

Returns the transceiver external outputs for the interface that was initialized for the task.

Series 2 XS cards enable connection of an external transceiver. For an external transceiver, this property allows you to determine the output voltage on the MODE0 and MODE1 pins of the CAN port, and it allows you to determine if the CAN controller chip is sleeping.

For more information on the format of the value returned in this property, refer to the description of **Interface Transceiver External Outputs** property in [CAN Set Property.vi](#).

This property is supported for Series 2 XS cards only.



### Interface Transceiver Mode

Returns the transceiver mode for the interface that was initialized for the task.

The transceiver mode changes when you set the mode within the application, or when a remote wakeup transitions the interface from **Sleep** to **Normal** mode. For more information, refer to [CAN Set Property.vi](#).

This property uses the following values:

Normal

Transceiver is awake in normal communication mode.

Sleep

Transceiver and the CAN controller chip are both in sleep mode.

Single Wire Wakeup

Single Wire transceiver is in Wakeup Transmission mode.

Single Wire High-Speed

Single Wire transceiver is in High-Speed Transmission mode.



### Interface Transceiver Type

Returns the type of transceiver for the interface that was initialized for the task. For hardware other than Series 2 XS cards, the transceiver type is fixed. For Series 2 XS cards, the transceiver type reflects the most recent value specified by MAX or [CAN Set Property.vi](#).

This property is not supported on the PCMCIA form factor.

This property uses the following values:

### High-Speed

Transceiver type is High-Speed (HS).

### Low-Speed/Fault-Tolerant

Transceiver type is Low-Speed/Fault-Tolerant (LS).

### Single Wire

Transceiver type is Single Wire (SW).

### External

Transceiver type is External. This transceiver type is available on Series 2 XS cards only. For more information, refer to [CAN Set Property.vi](#).

### Disconnect

Transceiver type is Disconnect. This transceiver type is available on Series 2 XS cards only. For more information, refer to [CAN Set Property.vi](#).



### Interface Transmit Error Counter

Returns the Transmit Error Counter as described in the CAN specification.

Since the error counts require the Philips SJA1000 CAN controller, this property is supported on Series 2 NI CAN hardware only. If you are using Series 1 NI CAN hardware, this property returns an error.



### Interface Virtual Bus Timing

Returns a Boolean value of **True** or **False** to indicate whether **Virtual Bus Timing** has been set or not for the specified virtual task. This property is applicable to all tasks opened on the virtual interface.

If this property is selected on real hardware, an error will be returned.



### Message ID

Returns the arbitration ID of the channel message.

To determine whether the ID is standard (11-bit) or extended (29-bit), get the **Message ID is Extended?** property.

The value of this property cannot be changed using [CAN Set Property.vi](#).



### Message ID is Extended?

Returns a Boolean value that indicates whether the arbitration ID of the channel message is standard 11-bit format (FALSE) or extended 29-bit format (TRUE).

The value of this property cannot be changed using [CAN Set Property.vi](#).



### Message Name

Returns the name of the channel message. The string is no more than 80 characters in length.

The value of this property cannot be changed using [CAN Set Property.vi](#).



### Message Number of Data Bytes

Returns the number of data bytes in the channel message. The range is 1 to 8.

The value of this property cannot be changed using [CAN Set Property.vi](#).



### Mode

Returns the mode initialized for the task, such as with [CAN Init Start.vi](#).



### Message Multiple Frame Distribution

Returns the **Message Multiple Frame Distribution** property which is used to determine if the CAN frames associated to a group of mode dependent channels are sent even spaced or in burst mode.



### Number of Channels

Returns the number of channels initialized in channel list. This is the number of array entries required when using [CAN Read.vi](#) or [CAN Write.vi](#).



### Channel Mode Dependency

Returns the number of mode dependent channels within a channel. So far a hierarchy of one mode dependent channel per channel is supported.

- 0 Channel is not mode dependent.
- 1 Channel is mode dependent.

This property applies only to mode dependent channels.



### Number of Samples Pending

Returns the number of samples available to be read using [CAN Read.vi](#). If you set the number of samples to read input of [CAN Read.vi](#) to this value, [CAN Read.vi](#) returns immediately without waiting.

This property applies only to tasks initialized with **mode** of **Input** and **sample rate** greater than zero. For all other configurations, it returns an error.



### Sample Rate

Returns the SampleRate initialized for the task, such as with [CAN Init Start.vi](#).



### Timeout

Returns the **Timeout** property, which is used with some task configurations. For more information, refer to the **Timeout** property in [CAN Set Property.vi](#).



### Value for invalid data

Returns the value that is returned on time stamped read for mode dependent channels that have not been received with the most recent CAN frame associated with the CAN message. This property applies only to mode dependent channels that are read with the time stamped read operation. For more information, refer to the *Mode Dependent Channels* section of Chapter 6, *Using the Channel API*.



### Version Build

Returns the build number of the NI-CAN software. This number applies to **Development**, **Alpha**, and **Beta** phase only, and should be ignored for **Release** phase.



### Version Comment

Returns a comment string for the NI-CAN software. If you received a custom release of NI-CAN from National Instruments, this comment often describes special features of the release.



### Version Major

Returns the major version of the NI-CAN software, such as the 2 in version 2.1.5.



### Version Minor

Returns the minor version of the NI-CAN software, such as the *1* in version *2.1.5*.



### Version Phase

Returns the phase of the NI-CAN software.

The value of Version Phase is an enumeration:

0	Development
1	Alpha
2	Beta
3	Release

Versions of NI-CAN in hardware kits or on `ni.com` will always be **Release**.



### Version Update

Returns the update version of the NI-CAN software, such as the *5* in version *2.1.5*.

## CAN Initialize.vi

### Purpose

Initialize a task for the specified channel list.

### Format

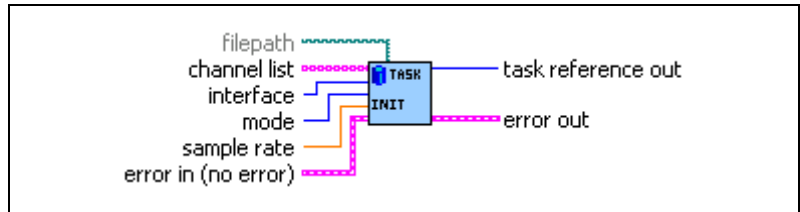

### Inputs



**filepath** is an optional path to a CAN database file from which to import the channel (signal) configurations.

If **filepath** is unwired (empty), the channel configuration is obtained from MAX. The MAX CAN channels are in the MAX CAN channels listing within **Data Neighborhood**.



**channel list** is the array of channel names to initialize as a task. Each channel name is provided in an array entry.

For more information, refer to the channel list input of [CAN Init Start.vi](#).



**interface** specifies the CAN interface to use for this task.

The interface input uses a ring typedef in which value 0 selects **CAN0**, value 1 selects **CAN1**, and so on.

The default (unwired) value is **MAX default**, which means to use the default interface as defined in the Message/Channel configuration properties. If the default interface in MAX is **All**, or if **filepath** is wired to use a CAN database (not MAX), the **interface** is a required input to this VI.

The Channel API and Frame API cannot use the same CAN network interface simultaneously. If the CAN network interface is already initialized in the Frame API, this function returns an error.

The special interface values 256 and 257 refer to virtual interfaces. For more information on usage of virtual interfaces, refer to the [Frame to Channel Conversion](#) section of Chapter 6, [Using the Channel API](#).



**mode** specifies the I/O mode for the task. For an overview of the I/O modes, including figures, refer to the *Channel API Basic Programming Model* section of Chapter 6, *Using the Channel API*.

### Input

Input channel data from received CAN messages. Use **CAN Read.vi** to obtain input samples as single-point, array, or waveform.

Use this input mode to read waveforms of timed samples, such as for comparison with NI-DAQ waveforms. You also can use this input mode to read a single point from the most recent message, such as for control or simulation.

For this mode, the channels in **channel list** can be contained in multiple messages.

### Output

Output channel data to CAN messages for transmit. Use **CAN Write.vi** to write output samples as single point, array, or waveform. Each sample value that you write is transmitted in a message on the network. If you write an array or waveform, the samples are buffered for subsequent transmit.

For this mode, there are restrictions on using channels in **channel list** that are contained in multiple messages. Refer to **CAN Write.vi** for more information.

### Output Recent

Output channel data to CAN messages for transmit. This mode is used with sample rate greater than zero (periodic transmit). Use **CAN Write.vi** to provide a single sample per channel. Each periodic message uses the sample values from the most recent **CAN Write.vi**.

For this mode, there are restrictions on using channels in channel list that are contained in multiple messages. Refer to **CAN Read.vi** for more information.

### Timestamped Input

Input channel data from received CAN messages. Use **CAN Read.vi** to obtain input samples as an array of sample/timestamp pairs (Poly VI types ending in *Timestamped Db1*).

Use this input mode to read samples with timestamps that indicate when each message is received from the network.

For this mode, the channels in **channel list** must be contained in a single message.



**sample rate** specifies the timing to use for samples of the task. The sample rate is specified in Hertz (samples per second). A sample rate of zero means to sample immediately.

For **mode** of **Input**, **sample rate** of zero means that **CAN Read.vi** returns a single point from the most recent message received, and greater than zero means that **CAN Read.vi** returns samples timed at the specified rate.

For **mode** of **Output**, **sample rate** of zero means that CAN messages transmit immediately when **CAN Write.vi** is called, and greater than zero means that CAN messages are transmitted periodically at the specified rate.

For **mode** of **Output Recent**, **sample rate** must be greater than zero (periodic transmit).

For **mode** of **Timestamped Input**, **sample rate** is ignored.

When the **interface** specifies a virtual interface (256 or 257), and **mode** is **Output** or **Output Recent**, this **sample rate** must be zero (greater than zero not supported).



**Error in** describes error conditions occurring before the VI executes. If an error has already occurred, the VI returns the value of the **Error in** cluster in **Error out**.



**status** is True if an error occurred. If **status** is True, the VI does not perform any operations.



**code** is the error code number identifying an error. A value of 0 means success. A negative value means error: VI did not execute the intended operation. A positive value means warning: VI executed intended operation, but an informational warning is returned. For a description of the **code**, wire the error cluster to a LabVIEW error-handling VI, such as the Simple Error Handler.



**source** identifies the VI where the error occurred.



## Outputs



Use **task reference out** with all subsequent VIs to reference the task. Wire this task reference to [CAN Start.vi](#) before you read or write samples for the message.



**Error out** describes error conditions. If the **Error in** cluster indicated an error, the **Error out** cluster contains the same information. Otherwise, **Error out** describes the error status of this VI.



**status** is True if an error occurred.



**code** is the error code number identifying an error. A value of 0 means success. A negative value means error: VI did not execute the intended operation. A positive value means warning: VI executed intended operation, but an informational warning is returned. For a description of the **code**, wire the error cluster to a LabVIEW error-handling VI, such as the Simple Error Handler.



**source** identifies the VI where the error occurred.

## Description

The [CAN Initialize.vi](#) VI does not start communication. This enables you to use [CAN Set Property.vi](#) to change the properties of the task, or [CAN Connect Terminals.vi](#) to synchronize CAN or DAQ cards. After you change properties or connections, use [CAN Start.vi](#) to start communication for the task.

## CAN Init Start.vi

### Purpose

Initialize a task for the specified channel list, then start communication.

### Format

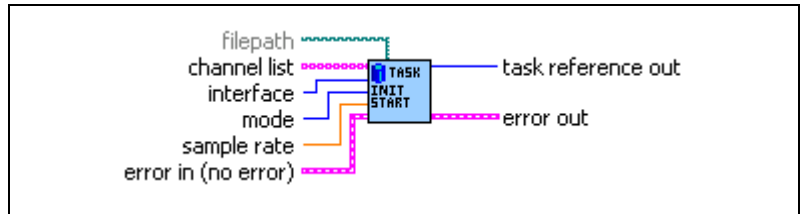

### Inputs



**filepath** is an optional path to a CAN database file from which to import the channel (signal) configurations.

If **filepath** is unwired (empty), the channel configuration is obtained from MAX. The MAX CAN channels are in the MAX CAN channels listing within **Data Neighborhood**.



**channel list** is the array of channel names to initialize and start as a task. Each channel name is provided in an array entry.

You can type in the channel list entries as string constants, or you can obtain the list from MAX or another CAN database by using [CAN Get Names.vi](#). Channel names are case sensitive.

You can initialize the same **channel list** with different **interface**, **mode**, or **sample rate**, because each task reference is unique.

The following paragraphs describe the syntax of each channel name. Brackets indicate optional fields.

*[message.]channel*

- *message* refers to the message in which the *channel* is contained. The message name must be followed by a decimal point.

If the *channel* name occurs in multiple messages, you must specify the *message* name to identify the channel uniquely. Within MAX, channels with the same name in multiple messages are shown with a yellow exclamation point.

If the *channel* name is unique across all channels, the *message* name is not required.

- *channel* refers to the channel (signal) name in MAX or the CAN database (indicated by **filepath**).

If you are using mode dependent channels, and each channel name is not unique, you will need to use a special syntax described in the [Mode Dependent Channel Syntax](#) section at the end of the function description.

The following examples demonstrate the channel list syntax:

1. List of channels, each channel name unique across all messages.

```
myChan1
myChan2
myChan3
```

If you are using mode dependent channels, and each channel name is not unique, you will need to use a special syntax described in the [Mode Dependent Channel Syntax](#) section at the end of the function description.

2. List of channels, with one channel duplicated across two messages. *MyChan2* and *MyChan3* must be unique across all messages.

```
myMessage1.myChan1
myChan2
myMessage2.myChan1
myChan3
```



**interface** specifies the CAN interface to use for this task.

The interface input uses a ring typedef in which value 0 selects **CAN0**, value 1 selects **CAN1**, and so on.

The default (unwired) value is **MAX default**, which means to use the default interface as defined in the Message/Channel configuration properties. If the default interface in MAX is **All**, or if **filepath** is wired to use a CAN database (not MAX), the **interface** is a required input to this VI.

The Channel API and Frame API cannot use the same CAN network interface simultaneously. If the CAN network interface is already initialized in the Frame API, this function returns an error.

The special interface values 256 and 257 refer to virtual interfaces. For more information on usage of virtual interfaces, refer to the [Frame to Channel Conversion](#) section of Chapter 6, [Using the Channel API](#).



**mode** specifies the I/O mode for the task. For an overview of the I/O modes, including figures, refer to the *Channel API Basic Programming Model* section of Chapter 6, *Using the Channel API*.

### Input

Input channel data from received CAN messages. Use **CAN Read.vi** to obtain input samples as single-point, array, or waveform.

Use this input mode to read waveforms of timed samples, such as for comparison with NI-DAQ waveforms. You also can use this input mode to read a single point from the most recent message, such as for control or simulation.

For this mode, the channels in **channel list** can be contained in multiple messages.

### Output

Output channel data to CAN messages for transmit. Use **CAN Write.vi** to write output samples as single-point, array, or waveform. Each sample value that you write is transmitted in a message on the network. If you write an array or waveform, the samples are buffered for subsequent transmit.

For this mode, there are restrictions on using channels in **channel list** that are contained in multiple messages. Refer to **CAN Write.vi** for more information.

### Output Recent

Output channel data to CAN messages for transmit. This mode is used with sample rate greater than zero (periodic transmit). Use **CAN Write.vi** to provide a single sample per channel. Each periodic message uses the sample values from the most recent **CAN Write.vi**.

For this mode, there are restrictions on using channels in channel list that are contained in multiple messages. Refer to **CAN Write.vi** for more information.

### Timestamped Input

Input channel data from received CAN messages. Use **CAN Read.vi** to obtain input samples as an array of sample/timestamp pairs (Poly VI types ending in *Timestamped Dbl*).

Use this input mode to read samples with timestamps that indicate when each message is received from the network.

For this mode, the channels in **channel list** must be contained in a single message.



**sample rate** specifies the timing to use for samples of the task. The sample rate is specified in Hertz (samples per second). A sample rate of zero means to sample immediately.

For **mode** of **Input**, a **sample rate** of zero means that **CAN Read.vi** returns a single point from the most recent message received, and greater than zero means that **CAN Read.vi** returns samples timed at the specified rate.

For **mode** of **Output**, a **sample rate** of zero means that CAN messages transmit immediately when **CAN Write.vi** is called, and greater than zero means that CAN messages are transmitted periodically at the specified rate.

For **mode** of **Output Recent**, **sample rate** must be greater than zero (periodic transmit).

For **mode** of **Timestamped Input**, **sample rate** is ignored.

When the **interface** specifies a virtual interface (256 or 257), and **mode** is **Output** or **Output Recent**, this **sample rate** must be zero (greater than zero not supported).



**Error in** describes error conditions occurring before the VI executes. If an error has already occurred, the VI returns the value of the **Error in** cluster in **Error out**.



**status** is True if an error occurred. If **status** is True, the VI does not perform any operations.



**code** is the error code number identifying an error. A value of 0 means success. A negative value means error: VI did not execute the intended operation. A positive value means warning: VI executed intended operation, but an informational warning is returned. For a description of the **code**, wire the error cluster to a LabVIEW error-handling VI, such as the Simple Error Handler.



**source** identifies the VI where the error occurred.

## Outputs



Use **task reference out** with all subsequent VIs to reference the running task. Because **CAN Init Start.vi** starts communication, you can wire this task reference to **CAN Read.vi** or **CAN Write.vi**.



**Error out** describes error conditions. If the **Error in** cluster indicated an error, the **Error out** cluster contains the same information. Otherwise, **Error out** describes the error status of this VI.



**status** is True if an error occurred.



**code** is the error code number identifying an error. A value of 0 means success. A negative value means error: VI did not execute the intended operation. A positive value means warning: VI executed intended operation, but an informational warning is returned. For a description of the **code**, wire the error cluster to a LabVIEW error-handling VI, such as the Simple Error Handler.



**source** identifies the VI where the error occurred.

## Description

The diagram for this VI simply calls **CAN Initialize.vi** followed by **CAN Start.vi**. This provides an easy way to start a list of channels.

The following list describes the scenarios for which **CAN Init Start.vi** cannot be used:

- If you need to set properties for the channels, use **CAN Initialize.vi**, then **CAN Set Property.vi**, then **CAN Start.vi**. **CAN Init Start.vi** starts communication, and most channel properties cannot be changed after the task is started.
- If you need to synchronize tasks for multiple NI-CAN or NI DAQ cards, refer to the VIs in the **CAN/DAQ Synchronization** palette, such as **CAN Sync Start with NI-DAQ.vi**.
- If you need to create channel configurations entirely within LabVIEW, without using MAX or a CAN database file, use **CAN Create Message.vi**, then **CAN Start.vi**. **CAN Init Start.vi** accepts only channel names defined in MAX or a CAN database file.

## Mode Dependent Channel Syntax

If you are using mode dependent channels, and each channel name is not unique, you will need to use a special syntax described in this section. Within MAX, channels with the same name are shown with a yellow exclamation point. For channels with unique names, you can use the simple syntax described previously for channel list. The brackets [] define optional parameters:

*[message name.[[multiplexer.]mode\_value.]]channel.*

- *message name* refers to the message in which the channel is contained. The message name must be followed by a decimal point.
- *multiplexer* refers to the multiplexer name in MAX or the CAN database. The multiplexer must be followed by a decimal point.
- *mode\_value* refers to the multiplexer mode in MAX or the CAN database. The mode\_value must be followed by a decimal point.
- *channel* refers to the channel (signal) name in MAX or the CAN database.

You cannot use the same channel name for a normal CAN channel and a mode dependent CAN channel within the same CAN message.

For more information on mode dependent channels, refer to the [Mode Dependent Channels](#) section of Chapter 6, [Using the Channel API](#).

# CAN Read.vi

## Purpose

Read samples from a CAN task initialized as input. Samples are obtained from received CAN messages. The poly VI selection determines the data type to read.

To select the data type, right-click the VI, go to **Select Type**, and select the type by name. For LabVIEW 7.0 and later, you can right-click the VI and select **Visible Items»Poly VI Selector** to select the data type from within the diagram. For an overview of **CAN Read**, refer to the [Read](#) and [Read Timestamped](#) sections of Chapter 6, *Using the Channel API*.

## Format

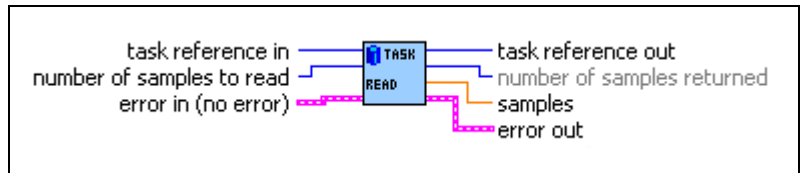

## Inputs



**task reference in** is the task reference from the previous NI-CAN VI. The task reference is originally returned from [CAN Init Start.vi](#), [CAN Initialize.vi](#), or [CAN Create Message.vi](#), and then wired through subsequent VIs.

The **mode** initialized for the task must be either **Input** or **Timestamped Input**.



**number of samples to read** specifies the number of samples to read for the task. For single-sample Poly VI types, [CAN Read.vi](#) always returns one sample, so this input is ignored.



**Error in** describes error conditions occurring before the VI executes. If an error has already occurred, the VI returns the value of the **Error in** cluster in **Error out**.



**status** is True if an error occurred. If **status** is True, the VI does not perform any operations.



**code** is the error code number identifying an error. A value of 0 means success. A negative value means error: VI did not execute the intended operation. A positive value means warning: VI executed intended operation, but an informational warning is



returned. For a description of the **code**, wire the error cluster to a LabVIEW error-handling VI, such as the Simple Error Handler.



**source** identifies the VI where the error occurred.

## Outputs



**task reference out** is the same as **task reference in**. Wire the task reference to subsequent VIs for this task.



**number of samples returned** indicates the number of samples returned in the **samples** output.



The poly output **samples** returns the samples read from received CAN messages. The type of the poly output is determined by the Poly VI selection. For information on the different poly VI types provided by **CAN Read.vi**, refer to the *Poly VI Types* section in this function reference.

To select the data type, right-click the VI, go to **Select Type**, and select the type by name.



**Error out** describes error conditions. If the **Error in** cluster indicated an error, the **Error out** cluster contains the same information. Otherwise, **Error out** describes the error status of this VI.



**status** is True if an error occurred.



**code** is the error code number identifying an error. A value of 0 means success. A negative value means error: VI did not execute the intended operation. A positive value means warning: VI executed intended operation, but an informational warning is returned. For a description of the **code**, wire the error cluster to a LabVIEW error-handling VI, such as the Simple Error Handler.



**source** identifies the VI where the error occurred.

## Poly VI Types

The name of each Poly VI type uses the following conventions:

- The first term is either **Single-Chan** or **Multi-Chan**. This indicates whether the type returns data for a single channel or multiple channels. **Multi-Chan** types return an array of analogous **Single-Chan** types, one entry for each channel initialized in **channel list** of **CAN Init Start.vi**. **Single-Chan** types are convenient because no array indexing is required, but you are limited to reading only one CAN channel.
- The second term is either **Single-Samp** or **Multi-Samp**. This indicates whether the type returns a single sample, or an array of multiple samples. **Single-Samp** types are often used for single point control applications, such as within LabVIEW RT.

- The third term indicates the data type used for each sample. The word *Dbl* indicates double-precision (64-bit) floating point. The word *Wfm* indicates the waveform data type. The words *1D* and *2D* indicate one and two-dimensional arrays, respectively. The words **Time & Dbl** indicate a cluster of a LabVIEW timestamp and a double-precision sample.

## Single-Chan Single-Samp Dbl

Returns a single sample for the first channel initialized in **channel list**.

If the initialized sample rate is greater than zero, this poly VI type waits for the next sample time, then returns a single sample. This enables you to execute a control loop at a specific rate.

If the initialized **sample rate** is zero, this poly VI immediately returns a single sample.

The **samples** output returns a single sample from the most recent message received. If no message has been received since you started the task, the Default Value of the channel is returned in **samples**.

You can use **error out** to determine whether a new message has been received since the previous call to **CAN Read.vi** (or **CAN Start.vi**). If no message has been received, the warning code 3FF62009 hex is returned in **error out**. If a new message has been received, the success code 0 is returned in **error out**.

To use this type, you must set the initialized mode to **Input** (not **Timestamped Input**).

Unless an error occurs, **number of samples returned** is one.

## Multi-Chan Single-Samp 1D Dbl

Returns an array, one entry for each channel initialized in **channel list**. Each entry consists of a single sample.

The order of channel entries in **samples** is the same as the order in the original **channel list**.

If the initialized sample rate is greater than zero, this poly VI type waits for the next sample time, then returns a single sample for each channel. This enables you to execute a control loop at a specific rate.

If the initialized **sample rate** is zero, this poly VI immediately returns a single sample for each channel.

The **samples** output returns a single sample for each channel from the most recent message received. If no message has been received for a channel since you started the task, the Default Value of the channel is returned in **samples**.

You can specify channels in **channel list** that span multiple messages. A sample from the most recent message is returned for all channels.

You can use **error out** to determine whether a new message has been received since the previous call to **CAN Read.vi** (or **CAN Start.vi**). If no message has been received for one or more channels, the warning **code** 3FF62009 hex is returned in **error out**. If a new message has been received for all channels, the success **code** 0 is returned in **error out**.

To use this type, you must set the initialized mode to **Input** (not **Timestamped Input**).

Unless an error occurs, **number of samples returned** is one. The **samples** array is indexed by channel, and the entry for each channel contains a single sample.

If you need to determine the number of channels in the task after initialization, get the **Number of Channels** property for the task reference.

### Single-Chan Multi-Samp 1D Dbl

Returns an array of samples for the first channel initialized in **channel list**.

The initialized sample rate must be greater than zero for this poly VI, because each sample in the array indicates the value of the CAN channel at a specific point in time. In other words, the **sample rate** specifies a virtual clock that copies the most recent value from CAN messages for each sample time. The changes in sample values from message to message enable you to view the CAN channel over time, such as for comparison with other CAN or DAQ input channels.

This VI waits until all samples arrive in time before returning. To avoid internal waiting within the VI, you can use **CAN Get Property.vi** to obtain the **Number Of Samples Pending**, and pass that as the **number of samples to read**.

If the initialized **sample rate** is zero, this poly VI returns an error. If the intent is simply to read the most recent sample for a task, use the **Single-Chan Single-Samp Dbl** type.

If no message has been received since you started the task, the Default Value of the channel is returned in all entries of the **samples** array.

You can use **error out** to determine whether a new message has been received since the previous call to **CAN Read.vi** (or **CAN Start.vi**). If no message has been received, the warning **code** 3FF62009 hex is returned in **error out**. If a new message has been received, the success **code** 0 is returned in **error out**.

To use this type, you must set the initialized mode to **Input** (not **Timestamped Input**).

Unless an error occurs, the **number of samples returned** is equal to **number of samples to read**.

## Multi-Chan Multi-Samp 2D Dbl

Returns an array, one entry for each channel initialized in **channel list**. Each entry consists of an array of samples.

The order of channel entries in **samples** is the same as the order in the original **channel list**.

The initialized sample rate must be greater than zero for this poly VI, because each sample in the array indicates the value of each CAN channel at a specific point in time. In other words, the **sample rate** specifies a virtual clock that copies the most recent value from CAN messages for each sample time. The changes in sample values from message to message enable you to view the CAN channels over time, such as for comparison with other CAN or DAQ input channels.

This VI waits until all samples arrive in time before returning. To avoid internal waiting within the VI, you can use **CAN Get Property.vi** to obtain the **Number Of Samples Pending**, and pass that as the **number of samples to read**.

If the initialized **sample rate** is zero, this poly VI returns an error. If the intent is simply to read the most recent samples for a task, use the **Multi-Chan Single-Samp 1D Dbl** type.

If no message has been received for a channel since you started the task, the Default Value of the channel is returned in **samples**.

You can specify channels in **channel list** that span multiple messages. At each point in time, a sample from the most recent message is returned for all channels.

You can use **error out** to determine whether a new message has been received since the previous call to **CAN Read.vi** (or **CAN Start.vi**). If no message has been received for one or more channels, the warning **code** 3FF62009 hex is returned in **error out**. If a new message has been received for all channels, the success **code** 0 is returned in **error out**.

To use this type, you must set the initialized mode to **Input** (not **Timestamped Input**).

Unless an error occurs, the **number of samples returned** is equal to **number of samples to read**.

If you need to determine the number of channels in the task after initialization, get the **Number of Channels** property for the task reference.

## Single-Chan Multi-Samp Wfm

Returns a single waveform for the first channel initialized in **channel list**.

The initialized sample rate must be greater than zero for this poly VI, because each sample in the array indicates the value of the CAN channel at a specific point in time. In other words, the **sample rate** specifies a virtual clock that copies the most recent value from CAN

messages for each sample time. The changes in sample values from message to message enable you to view the CAN channel over time, such as for comparison with other CAN or DAQ input channels.

This VI waits until all samples arrive in time before returning. To avoid internal waiting within the VI, you can use [CAN Get Property.vi](#) to obtain the **Number Of Samples Pending**, and pass that as the **number of samples to read**.

The start time of a waveform indicates the time of the first CAN sample in the array. The delta time of the waveform indicates the time between each sample in the array, as determined by the original **sample rate**.

If the initialized **sample rate** is zero, this poly VI returns an error. If the intent is to simply read the most recent sample for a task, use the **Single-Chan Single-Samp Dbl** type.

If no message has been received since you started the task, the Default Value of the channel is returned in all entries of the **samples** waveform.

You can use **error out** to determine whether a new message has been received since the previous call to [CAN Read.vi](#) (or [CAN Start.vi](#)). If no message has been received, the warning **code** 3FF62009 hex is returned in **error out**. If a new message has been received, the success **code** 0 is returned in **error out**.

To use this type, you must set the initialized **mode** to **Input** (not Timestamped Input).

Unless an error occurs, the **number of samples returned** is equal to **number of samples to read**.

## Multi-Chan Multi-Samp 1D Wfm

Returns an array, one entry for each channel initialized in **channel list**. Each entry consists of a single waveform.

The order of channel entries in **samples** is the same as the order in the original **channel list**.

The initialized sample rate must be greater than zero for this poly VI, because each sample in the array of a waveform indicates the value of the CAN channel at a specific point in time. In other words, the **sample rate** specifies a virtual clock that copies the most recent value from CAN messages for each sample time. The changes in sample values from message to message enable you to view the CAN channel over time, such as for comparison with other CAN or DAQ input channels.

This VI waits until all samples arrive in time before returning. To avoid internal waiting within the VI, you can use [CAN Get Property.vi](#) to obtain the **Number Of Samples Pending**, and pass that as the **number of samples to read**.

The *start time* of a waveform indicates the time of the first CAN sample in the array. The *delta time* of a waveform indicates the time between each sample in the array, as determined by the original **sample rate**.

If the initialized **sample rate** is zero, this poly VI returns an error. If the intent is simply to read the most recent samples for a task, use the **Multi-Chan Single-Samp 1D Dbl** type.

If no message has been received for a channel since you started the task, the Default Value of the channel is returned in **samples**.

You can specify channels in **channel list** that span multiple messages. At each point in time, a sample from the most recent message is returned for all channels.

You can use **error out** to determine whether a new message has been received since the previous call to **CAN Read.vi** (or **CAN Start.vi**). If no message has been received for one or more channels, the warning **code** 3FF62009 hex is returned in **error out**. If a new message has been received for all channels, the success **code** 0 is returned in **error out**.

To use this type, you must set the initialized mode to **Input** (not **Timestamped Input**).

Unless an error occurs, the **number of samples returned** is equal to **number of samples to read**.

If you need to determine the number of channels in the task after initialization, get the **Number of Channels** property for the task reference.

## Single-Chan Multi-Samp 1D Time & Dbl

Returns an array of clusters. Each cluster corresponds to a received message for the first channel initialized in **channel list**. Each cluster contains the sample value, and a timestamp that indicates when the message was received.

To use this type, you must set the initialized mode to **Timestamped Input** (not **Input**).

The **Timeout** property determines whether this VI will wait for the **number of samples to read** messages to arrive from the network. The default value of **Timeout** is zero, but you can change it using **CAN Set Property.vi**.

If **Timeout** is greater than zero, the VI will wait for **number of samples to read** messages to arrive. If **number of samples to read** messages are not received before the **Timeout** expires, an error is returned. **Timeout** is specified as milliseconds.

If **Timeout** is zero, the VI will not wait for messages, but instead returns samples from the messages received since the previous call to **CAN Read.vi**. The number of samples returned is indicated in the **number of samples returned** output, up to a maximum of **number of**

**samples to read** messages. If no new message has been received, **number of samples returned** is 0, and **error out** indicates success.

Because the timing of values in **samples** is determined by when the message is received, the sample rate input is not used with this poly VI type.

## Multi-Chan Multi-Samp 2D Time & DbI

Returns an array, one entry for each channel initialized in **channel list**. Each entry consists of an array of clusters. Each cluster corresponds to a received message for the channels initialized in **channel list**. Each cluster contains the sample value, and a timestamp that indicates when the message was received.

The order of channel entries in **samples** is the same as the order in the original **channel list**.

To use this type, you must set the initialized mode to **Timestamped Input** (not **Input**).

You cannot specify channels in **channel list** that span multiple messages.

The **Timeout** property determines whether this VI waits for the **number of samples to read** messages to arrive from the network. The default value of **Timeout** is zero, but you can change it using [CAN Set Property.vi](#).

If **Timeout** is greater than zero, the VI will wait for **number of samples to read** messages to arrive. If **number of samples to read** messages are not received before the **Timeout** expires, an error is returned. **Timeout** is specified as milliseconds.

If **Timeout** is zero, the VI will not wait for messages, but instead returns samples from the messages received since the previous call to [CAN Read.vi](#). The number of samples returned is indicated in the **number of samples returned** output, up to a maximum of **number of samples to read** messages. If no new message has been received, **number of samples returned** is 0, and **error out** indicates success.

Because the timing of values in **samples** is determined by when the message is received, the sample rate input is not used with this poly VI type.

If you need to determine the number of channels in the task after initialization, get the **Number of Channels** property for the task reference.

## CAN Set Property.vi

### Purpose

Set a property for the task, or a single channel within the task. The poly VI selection determines the property to set.

To select the property, right-click the VI, go to **Select Type** and select the property by name. For LabVIEW 7.0 and later, you can right-click the VI and select **Visible Items»Poly VI Selector** to select the property from within the diagram.

### Format

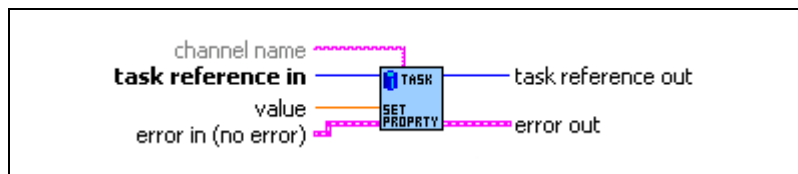

### Inputs



**task reference in** is the task reference from the previous NI-CAN VI. The task reference is originally returned from VIs such as [CAN Initialize.vi](#) or [CAN Create Message.vi](#), and then wired through subsequent VIs.



**channel name** specifies an individual channel within the task. The default (unwired) value of channel name is empty, which means that the property applies to the entire task, not a specific channel.

Properties that begin with the word *Channel* or *Message* do not apply to the entire task, but an individual channel or message within the task. For these channel-specific properties, you must wire the name of a channel from **channel list** into the **channel name** input.

For properties that do not begin with the word *Channel* or *Message*, you must leave **channel name** unwired (empty).



The poly input **value** specifies the property value. You select the property to set as **value** by selecting the Poly VI type. The data type of **value** is also determined by the Poly VI selection. For information on the different properties provided by [CAN Get Property.vi](#), refer to the *Poly VI Types* section in this function reference.



To select the property, right-click the VI, go to **Select Type** and select the property by name. **Error in** describes error conditions occurring before the



VI executes. If an error has already occurred, the VI returns the value of the **Error in** cluster in **Error out**.



**status** is True if an error occurred. If **status** is True, the VI does not perform any operations.



**code** is the error code number identifying an error. A value of 0 means success. A negative value means error: VI did not execute the intended operation. A positive value means warning: VI executed intended operation, but an informational warning is returned. For a description of the **code**, wire the error cluster to a LabVIEW error-handling VI, such as the Simple Error Handler.



**source** identifies the VI where the error occurred.

## Outputs



**task reference out** is the same as **task reference in**. Wire the task reference to subsequent VIs for this task.



**Error out** describes error conditions. If the **Error in** cluster indicated an error, the **Error out** cluster contains the same information. Otherwise, **Error out** describes the error status of this VI.



**status** is True if an error occurred.



**code** is the error code number identifying an error. A value of 0 means success. A negative value means error: VI did not execute the intended operation. A positive value means warning: VI executed intended operation, but an informational warning is returned. For a description of the **code**, wire the error cluster to a LabVIEW error-handling VI, such as the Simple Error Handler.



**source** identifies the VI where the error occurred.

## Description

You cannot set a property while the task is running. If you need to change a property prior to starting the task, you cannot use **CAN Init Start.vi**. First, call **CAN Initialize.vi**, followed by **CAN Set Property.vi** and then **CAN Start.vi**. After you start the task, you also can change a property by calling **CAN Stop.vi**, followed by **CAN Set Property.vi**, and then **CAN Start.vi** again.

## Poly VI Types



### Behavior After Final Output

The **Behavior After Final Output** property applies only to tasks initialized with mode of **Output**, and sample rate greater than zero. The value specifies the behavior to perform after the final periodic sample is transmitted.

**Behavior After Final Output** uses the following values:

#### Repeat Final Sample

Transmit messages for the final sample(s) repeatedly. The final messages are transmitted periodically as specified by **sample rate**.

If there is significant delay between subsequent calls to **CAN Write.vi**, this value means that periodic messages continue between **CAN Write.vi** calls, and messages with the data of the final sample will be repeated on the network.

**Repeat Final Sample** is the default value of the **Behavior After Final Output** property.

#### Cease Transmit

Cease transmit of messages until the next call to **CAN Write.vi**.

If there is significant delay between subsequent calls to **CAN Write.vi**, this value means that periodic messages cease between **CAN Write.vi** calls, and the data of the final sample will not be repeated on the network.



### Channel Default Value

Sets the default value of the channel in scaled floating-point units.

For information on how the **Channel Default Value** is used, refer to **CAN Read.vi** and **CAN Write.vi**.

The value of this property is originally set within MAX. If the channel is initialized directly from a CAN database, the value is 0.0 by default, but it can be changed using **CAN Set Property.vi**.



### Hardware Master Timebase Rate

Sets the rate (in MHz) of the external clock that is exported to the CAN card.

The values for this property are:

**20 MHz** (20 decimal) When synchronizing 2 CAN cards or synchronizing a CAN card with an E-Series DAQ card, the 20 MHz master timebase rate is to be used. By default, this property is set to 20 MHz.

Transmit messages for the final sample(s) repeatedly. The final messages are transmitted periodically as specified by **sample rate**.

**10 MHz** (10 decimal) The master timebase rate should be set to 10 MHz when synchronizing a CAN card with an M-Series DAQ card. The M-Series DAQ card can export a 20 MHz clock but it does this by using one of its two counters.

If your CAN-DAQ application does not use the 2 DAQ counters then, you can leave the timebase rate set to 20 MHz (default).

This property can be set either before or after calling **CAN Connect Terminals.vi** to connect the **RTSI\_CLK** to **Master Timebase**. However, this property must always be called prior to starting the task.

This property is applicable only to PCI and PXI Series 2 cards. For PCMCIA cards, setting this attribute will return an error. On PXI cards, if **PXI\_CLK10** is routed to the **Master Timebase**, then the rate is fixed at 10 MHz (it over-rides any previous setting of this property). Setting this property for Series 1 cards will also result in a NI-CAN error.



### Hardware Timestamp Format

Sets the format of the timestamps reported by the on-board timer on the CAN card. The default value for this property is Absolute.

The values for this property are:

0 (**Absolute**) Sets the timestamp format to absolute. In the absolute format, the timestamp returned by NI-CAN read functions is the LabVIEW date/time format (DBL representing the number of seconds elapsed since 12:00 a.m., Friday, January 1, 1904).

1 (**Relative**) Sets the timestamp format to relative. In the relative format, the timestamp returned by the NI-CAN read functions will be zero based (DBL representing the number of seconds since the CAN controller for that task was started).

A typical use case for this property would be if data received from two RTSI synchronized CAN cards is to be correlated. For that use case, this property must be set to 1 for all of the CAN cards being synchronized. Setting this property on one port of a 2-port card will also reset the timestamp of the second port, since resetting the timestamp on the CAN port involves resetting the on-board timer.

This property should be set prior to starting any tasks on the CAN card.

**U32**

**Interface Baud Rate** Sets the baud rate in use by the interface.

This property applies to all tasks initialized with the **Interface**.

You can specify the following basic baud rates as the numeric rate: 33333, 83333, 100000, 125000, 200000, 250000, 400000, 500000, 800000, and 1000000. You can specify advanced baud rates as 8000XXYY hex, where *YY* is the value of Bit Timing Register 0 (BTR0), and *XX* is the value of Bit Timing Register 1 (BTR1) of the CAN controller. For more information, refer to the Interface Properties dialog in MAX.

The value of this property is originally set within MAX.

**TF**

**Interface Listen Only?**

Sets a Boolean value that indicates whether the listen only feature of the Philips SJA1000 CAN controller is enabled (TRUE) or disabled (FALSE).

This property applies to all tasks initialized with the Interface.

If **Interface Listen Only?** is False, the Interface can transmit CAN messages; therefore, **CAN Write.vi** operates normally. When CAN messages are received by the Interface, those messages are acknowledged. Because False is the behavior specified in the CAN specification, it is the default value of **Interface Listen Only?**

If **Interface Listen Only?** is True, the Interface cannot transmit CAN messages; therefore, **CAN Write.vi** returns an error. When CAN messages are received by the Interface, those messages are *not* acknowledged. The Philips SJA1000 CAN controller enters the error passive state when listen only is enabled (but no error-passive warning is returned). The True value of **Interface Listen Only?** enables passive monitoring of network traffic, which can be useful for debugging scenarios in which only one device exists on the network.

Since the listen only feature requires the Philips SJA1000 CAN controller, this property is supported on Series 2 NI CAN hardware only. If you are

using Series 1 NI CAN hardware, an attempt to set this property returns error `nctErrRequiresNewSeries` (code BFF6210D hex, status T).



### Interface Self Reception?

Specifies whether to echo successfully transmitted CAN frames as received frames. Each reception occurs just as if the frame were received from another CAN device. This enables you to initialize the same channels for both input and output.

For self reception to operate properly, another CAN node must receive and acknowledge each transmit.

FALSE disables self reception mode (default), and TRUE enables self reception mode.

The self reception mode is not available on the Intel 82527 CAN controller used by Series 1 CAN hardware. For Series 1 hardware, this property must be left at its default (FALSE).



### Interface Series 2 Comparator

Specifies the filter comparator for the Philips SJA1000 CAN controller on all Series 2 CAN hardware. This property is not supported for Series 1 hardware (returns error).

This property specifies a comparator value that is checked against the ID, RTR, and data bits. The **Interface Series 2 Mask** determines the applicable bits for comparison.

The default value of this property is zero.

The mapping of bits in this property to the ID, RTR, and data bits of incoming frames is determined by the value of the **Interface Series 2 Filter Mode** property. The Series 2 filter mode determines the format of this property as well as the Series 2 mask.



### Interface Series 2 Filter Mode

All Series 2 hardware uses the Philips SJA1000 CAN controller. The Philips SJA1000 CAN controller provides sophisticated filtering of received frames. This property specifies the filtering mode, which is used in conjunction with the **Interface Series 2 Mask** and **Interface Series 2 Comparator** properties.

This property is not supported for Series 1 hardware (returns error).

Since the format of the Series 2 filters is very specific to the Philips SJA1000 CAN controller, National Instruments cannot guarantee compatibility for this property on future hardware series. When using this property in the application, it is best to get the **Hardware Series** property to verify that the CAN hardware is Series 2.

The filtering specified by the Series 2 filter properties applies to all input tasks for that interface. For example, if you specify filters that discard ID 5, then open an Input task to receive channels of ID 5, the task will not receive data.

The default value for this property is **Single Standard**.

The values for this property are summarized below. For detailed information on each value, including the format of the Interface Series 2 Mask and Interface Series 2 Comparator properties for each mode, refer to the **Series 2 Filter Mode** attribute in the [ncSetAttr.vi](#) function of the Frame API.

### Single Standard

Filter all standard (11-bit) frames using a single mask/comparator filter.

### Single Extended

Filter all extended (29-bit) frames using a single mask/comparator filter.

### Dual Standard

Filter all standard (11-bit) frames using a two separate mask/comparator filters. If either filter matches the frame, it is received. The frame is discarded only when neither filter detects a match.

### Dual Extended

Filter all extended (29-bit) frames using a two separate mask/comparator filters. If either filter matches the frame, it is received. The frame is discarded only when neither filter detects a match.



### Interface Series 2 Mask

Specifies the filter mask for the Philips SJA1000 CAN controller on all Series 2 CAN hardware. This property is not supported for Series 1 hardware (returns error).

This property specifies a bit mask that determines the ID, RTR, and data bits that are compared. If a bit is clear in the mask, the corresponding bit in

the **Interface Series 2 Comparator** is checked. If a bit in the mask is set, that bit is ignored for the purpose of filtering (don't care).

The default value of this property is hex FFFFFFFF, which means that all messages are received.

The mapping of bits in this property to the ID, RTR, and data bits of incoming frames is determined by the value of the **Interface Series 2 Filter Mode** property. The Series 2 filter mode determines the format of this property as well as the Series 2 comparator.



### **Interface Single Shot Transmit?**

Specifies whether to retry failed CAN frame transmissions (Series 2 only).

If **Interface Single Shot Transmit?** is False (default), failed transmissions retry as defined in the CAN specification. If a CAN frame is not transmitted successfully, the CAN controller will immediately retry.

If **Interface Single Shot Transmit?** is True, all transmissions are single shot. If a CAN frame is not transmitted successfully, the CAN controller will not retry.

The single-shot transmit feature is not available on the Intel 82527 CAN controller used by Series 1 CAN hardware (set returns error).



### **Interface Transceiver External Outputs**

Sets the transceiver external outputs for the interface that was initialized for the task.

Series 2 XS cards enable connection of an external transceiver. For an external transceiver, this property allows you to set the output voltage on the MODE0 and MODE1 pins of the CAN port, and it allows you control the sleep mode of the on-board CAN controller chip.

For many models of CAN transceiver, EN and NSTB pins control the transceiver mode, such as whether the transceiver is sleeping or communicating normally. For such transceivers, you can wire the EN and NSTB pins to the MODE0 and MODE1 pins of the CAN port.

The default value of this property is **0000003** hex. For many models of transceiver, this specifies normal communication mode for the transceiver and CAN controller chip. If the transceiver requires a different MODE0/MODE1 combination for normal mode, you can use external inverters to change the default 5 V to 0 V.

This property is supported for Series 2 XS cards only. This property is not supported when the **Interface Transceiver Type** is any value other than **External**. To control the mode of an internal transceiver, use the **Interface Transceiver Mode** property.

This property uses a bit mask. Use bitwise OR operations to set multiple values.

**00000001** hex MODE0

Set this bit to drive 5 V on the MODE0 pin. This is the default value. This bit is set automatically when a remote wakeup is detected.

Clear this bit to drive 0 V on the MODE0 pin.

**00000002** hex MODE1

Set this bit to drive 5 V on the MODE1 pin. This is the default value. This bit is set automatically when a remote wakeup is detected.

Clear this bit to drive 0 V on the MODE1 pin.

**0000100** hex Sleep CAN controller chip

Set this bit to place the CAN controller chip into sleep mode. This bit controls the mode of the CAN controller chip (sleep or normal), and the independent MODE0/MODE1 bits control the mode of the external transceiver. When you set this bit to place the CAN controller into sleep mode, you typically specify MODE0/MODE1 bits that place the external transceiver into sleep mode as well.

When the CAN controller is asleep, a remote wakeup will automatically place the CAN controller into its normal mode of communication. In addition, the MODE0/MODE1 pins are restored to their default values of 5 V. Therefore, a remote wakeup causes this property to change from the value that you set for sleep mode, back to its default **00000003** hex. You can determine when this has occurred by getting **Interface Transceiver External Outputs** using **CAN Get Property.vi**. For more information on remote wakeup, refer to the **Interface Transceiver Mode** property for internal transceivers.

Clear this bit to place the CAN controller chip into normal communication mode. If the CAN controller was previously in sleep mode, this performs a local wakeup to restore communication.





## Interface Transceiver Mode

Sets the transceiver mode for the interface that was initialized for the task. The transceiver mode controls whether the transceiver is asleep or communicating, as well as other special modes.

This property is supported on Series 2 cards only.

For Series 2 cards for the PCMCIA form factor, this property requires a corresponding Series 2 cable (dongle). For information on how to identify the series of the PCMCIA cable, refer to the [Series 2 Vs. Series 1](#) section of Chapter 1, [Introduction](#).

For Series 2 XS cards, this property is not supported when the **Interface Transceiver Type** is **External**. To control the mode of an external transceiver, use the **Interface Transceiver External Outputs** property.

The default value for this property is **Normal**.

This property uses the following values:

### Normal

Set transceiver to normal communication mode. If you set **Sleep** mode previously, this performs a local wakeup of the transceiver and CAN controller chip.

### Sleep

Set transceiver and the CAN controller chip to sleep (or standby) mode.

If the transceiver supports multiple sleep/standby modes, the NI CAN hardware implementation ensures that all of those modes are equivalent with regard to the behavior of the transceiver on the network. For more information on the physical specifications for normal and sleep modes for each transceiver, refer to Chapter 3, [NI CAN and LIN Hardware](#).

You can set **Sleep** mode only while the interface is communicating. If at least one task for the interface has not been started (such as with [CAN Start.vi](#)), setting the transceiver mode to **Sleep** will return an error.

When the interface enters sleep mode, communication is not possible until a wakeup occurs. All pending frame transmissions are deferred until the wakeup occurs. The transceiver and CAN controller wake from sleep mode when either a local wakeup or remote wakeup occurs.

If you set **Sleep** mode when the CAN controller is actively transmitting a frame (that is, won arbitration), the interface will not enter **Sleep** mode until the frame is transmitted successfully (acknowledgement detected).

A local wakeup occurs when the application sets the transceiver mode to **Normal** (or some other communication mode).

A remote wakeup occurs when a remote node transmits a CAN frame (referred to as the wakeup frame). The wakeup frame wakes up the transceiver and CAN controller chip of the NI CAN interface. The wakeup frame is not received or acknowledged by the CAN controller chip. When the wakeup frame ends, the NI CAN interface enters **Normal** mode, and again receives and transmits CAN frames. If the node that transmitted the wakeup frame did not detect an acknowledgement (such as if other nodes were also waking), it will retry the transmission, and the retry will be received by the NI CAN interface.

For a remote wakeup to occur for Single Wire transceivers, the node that transmits the wakeup frame must first place the network into the Single Wire Wakeup Transmission mode by asserting a higher voltage (typically 12 V). For more information, refer to the **Single Wire Wakeup** mode.

When the local or remote wakeup occurs, frame transmissions resume from the point at which the original **Sleep** was set.

You can detect when a remote wakeup occurs by using **CAN Get Property.vi** with the **Interface Transceiver Mode** property.

### Single Wire Wakeup

Set Single Wire transceiver to **Wakeup Transmission** mode.

This mode is supported on **Single Wire** (SW) ports only.

The Single Wire Wakeup Transmission mode drives a higher voltage level on the network to wake up all sleeping nodes. Other than this higher voltage, this mode is similar to **Normal** mode. CAN frames can be received and transmitted normally.

Since you use the **Single Wire Wakeup** mode to wake up other nodes on the network, it is not typically used in combination with **Sleep** mode for a given interface.

The timing of how long the wakeup voltage is driven is controlled entirely by the application. Your application will typically change to **Single Wire Wakeup** mode, transmit a wakeup frame, then return to **Normal** mode.

The following sequence demonstrates a typical sequence of steps for sleep and wakeup between two Single Wire NI CAN interfaces. The sequence assumes that CAN0 is the sleeping node, and CAN1 originates the wakeup.

1. Start both CAN0 and CAN1. Both use the default **Normal** mode.
2. Set **Interface Transceiver Mode** of CAN0 to **Sleep**.
3. Set **Interface Transceiver Mode** of CAN1 to **Single Wire Wakeup**.
4. Write data to CAN1 to transmit a wakeup frame to CAN0.
5. Set **Interface Transceiver Mode** of CAN1 to **Normal**.
6. Now both CAN0 and CAN1 are in **Normal** mode again.

### Single Wire High-Speed

Set Single Wire transceiver to **High-Speed Transmission** mode.

This mode is supported on Single Wire (SW) ports only.

The **Single Wire High-Speed Transmission** mode disables the internal waveshaping function of the transceiver, which allows baud rates up to 100 kbytes/s to be used. The disadvantage versus **Normal** (which allows up to 40 kbytes/s baud) is degraded EMC performance. Other than the disabled waveshaping, this mode is similar to **Normal** mode. CAN frames can be received and transmitted normally.

This mode has no relationship to High-Speed (HS) transceivers. It is merely a higher speed mode of the Single Wire (SW) transceiver, typically used for downloading large amounts of data to a node.

The Single Wire transceiver does not support use of this mode in conjunction with **Sleep** mode. For example, a remote wakeup cannot transition from **Sleep** to this **Single Wire High-Speed** mode.



### Interface Transceiver Type

For XS software selectable physical layer cards that provide a software-switchable transceiver, the **Interface Transceiver Type** property sets the type of transceiver. When the transceiver is switched from one type to another, NI-CAN ensures that the switch is undetectable from the perspective of other nodes on the network.

The default value for this property is specified within MAX. If you change the transceiver type in MAX to correspond to the network in use, you can avoid setting this property within the application.

This property applies to all tasks initialized with the same interface.

You cannot set this property for Series 1 hardware, or for Series 2 hardware other than XS (fixed HS, LS, or SW cards).

This property uses the following values:

### **High-Speed**

Switch the transceiver to **High-Speed** (HS).

### **Low-Speed/Fault-Tolerant**

Switch the transceiver to **Low-Speed/Fault-Tolerant** (LS).

### **Single Wire**

Switch the transceiver to **Single Wire** (SW).

### **External**

Switch the transceiver to **External**. The External type allows you to connect a transceiver externally to the interface. For more information on connecting transceivers externally, refer to Chapter 3, *NI CAN and LIN Hardware*.

When this transceiver type is selected, you can use the **Transceiver External Outputs** and **Transceiver External Inputs** properties to access the external mode and status pins of the connector.

### **Disconnect**

Disconnect the CAN controller chip from the connector. This value is used when you physically switch an external transceiver. You first set **Interface Transceiver Type** to **Disconnect**, then switch from one external transceiver to another, then set **Interface Transceiver Type** to **External**. For more information on connecting transceivers externally, refer to Chapter 3, *NI CAN and LIN Hardware*.



### **Interface Virtual Bus Timing**

Sets the **Virtual Bus Timing** of the virtual device.

**Interface Virtual Bus Timing** uses the following values:

- 0 (**False**) Virtual Bus Timing is turned off. By turning Virtual Bus Timing off, the CAN bus simulation is disabled and CAN frames are copied from the write queue of one virtual interface to the read queue of the second virtual interface. This setting is useful if you desire to only convert frames to channels or vice versa and not simulate actual CAN bus communication.
- 1 (**True**) Virtual Bus Timing is turned on (default). By turning Virtual Bus Timing on, frame timestamps are recalculated as they transfer across the virtual bus. This mode is useful when you want the virtual bus to behave as much like a real bus as possible.

If this property is set on real hardware, an error will be returned.

Virtual Bus Timing has to be set to the same value on both virtual interfaces. This property must be set prior to starting the virtual interface. Refer to the [Frame to Channel Conversion](#) section of Chapter 6, [Using the Channel API](#) for more information.



### **Message Multiple Frame Distribution**

Sets the **Message Multiple Frame Distribution** property which is used to determine if the CAN frames associated to a group of mode dependent channels are sent even spaced or in burst mode.

**Message Multiple Frame Distribution** uses the following values:

- 0 **Uniform** **Uniform** distribution transmits mode dependent messages uniformly (evenly spaced) on the network.
- 1 **Burst** **Burst** distribution transmits mode dependent messages back to back on the network. This property applies only to mode dependent channels that are transmitted periodically. For more information, refer to the [Mode Dependent Channels](#) section of Chapter 6, [Using the Channel API](#).



## Timeout

Sets a time in milliseconds to wait for samples. The default value is zero.

For all task configurations, the **Timeout** specifies the time that **Read** will wait for the start trigger. If the application does not use **CAN Connect Terminals**, the start trigger occurs when the task starts (CAN Start). If you connect a start trigger from a RTSI line or other source, **Timeout** specifies the number of milliseconds to wait. **Timeout** of zero means to wait up to 10 seconds for the start trigger.

Use of the **Timeout** property depends on the initialized mode of the task:

- **Output**— For each **Output** task, NI-CAN uses a buffer to store samples for transmit. If the number of samples that you provide to **CAN Write.vi** exceeds the size of the underlying buffer, NI-CAN waits for sufficient space to become available (due to successful transmits). The **Timeout** specifies the number of milliseconds to wait for available buffer space. **Timeout** of zero means to wait up to 10 seconds.
- **Input**— The timeout value does *not* apply. For **Input** tasks initialized with **sample rate** greater than zero, the **number of samples to read** input to **CAN Read.vi** implicitly specifies the time to wait. For **Input** tasks initialized with **sample rate** equal to zero, the **CAN Read.vi** VI always returns available samples immediately, without waiting.
- **Timestamped Input**— A timeout of zero means to return available samples immediately. A timeout greater than zero means that **CAN Read.vi** will wait a maximum of **Timeout** milliseconds for **number of samples to read** samples to become available before returning.
- **Output Recent**— The timeout value does not apply.



## Value for invalid data

Sets the value that is returned on time stamped read for mode dependent channels that have not been received with the most recent CAN frame associated with the CAN message. This property applies only to mode dependent channels that are read with the time stamped read operation. For more information, refer to the *Mode Dependent Channels* section of Chapter 6, *Using the Channel API*.

## CAN Start.vi

### Purpose

Start communication for the specified task.

### Format



### Inputs



**task reference in** is the task reference from the previous NI-CAN VI. The task reference is originally returned from VIs such as [CAN Initialize.vi](#) or [CAN Create Message.vi](#), and then wired through subsequent VIs.



**Error in** describes error conditions occurring before the VI executes. If an error has already occurred, the VI returns the value of the **Error in** cluster in **Error out**.



**status** is True if an error occurred. If **status** is True, the VI does not perform any operations.



**code** is the error code number identifying an error. A value of 0 means success. A negative value means error: VI did not execute the intended operation. A positive value means warning: VI executed intended operation, but an informational warning is returned. For a description of the **code**, wire the error cluster to a LabVIEW error-handling VI, such as the Simple Error Handler.



**source** identifies the VI where the error occurred.

### Outputs



**task reference out** is the same as **task reference in**. Wire the task reference to subsequent VIs for this task.



**Error out** describes error conditions. If the **Error in** cluster indicated an error, the **Error out** cluster contains the same information. Otherwise, **Error out** describes the error status of this VI.



**status** is True if an error occurred.

**code** is the error code number identifying an error. A value of 0 means success. A negative value means error: VI did not execute the intended operation. A positive value means warning: VI executed intended operation, but an informational warning is returned. For a description of the **code**, wire the error cluster to a LabVIEW error-handling VI, such as the Simple Error Handler.



**source** identifies the VI where the error occurred.

## Description

You must start communication for a task to use [CAN Read.vi](#) or [CAN Write.vi](#). After you start communication, you can no longer change the configuration of the task with [CAN Set Property.vi](#) or [CAN Connect Terminals.vi](#).



# CAN Stop.vi

## Purpose

Stop communication for the specified task.

## Format

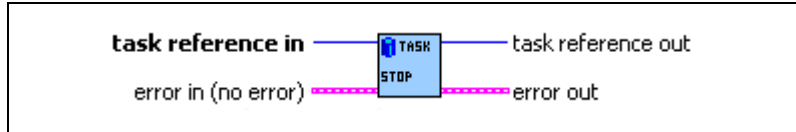

## Inputs



**task reference in** is the task reference from the previous NI-CAN VI. The task reference is originally returned from **CAN Init Start.vi**, **CAN Initialize.vi**, or **CAN Create Message.vi**, and then wired through subsequent VIs.



**Error in** describes error conditions occurring before the VI executes. If an error has already occurred, the VI returns the value of the **Error in** cluster in **Error out**.



**status** is True if an error occurred. If **status** is True, the VI does not perform any operations.



**code** is the error code number identifying an error. A value of 0 means success. A negative value means error: VI did not execute the intended operation. A positive value means warning: VI executed intended operation, but an informational warning is returned. For a description of the **code**, wire the error cluster to a LabVIEW error-handling VI, such as the Simple Error Handler.



**source** identifies the VI where the error occurred.

## Outputs



**task reference out** is the same as **task reference in**. Wire the task reference to subsequent VIs for this task.



**Error out** describes error conditions. If the **Error in** cluster indicated an error, the **Error out** cluster contains the same information. Otherwise, **Error out** describes the error status of this VI.



**status** is True if an error occurred.



**code** is the error code number identifying an error. A value of 0 means success. A negative value means error: VI did not execute the intended operation. A positive value means warning: VI executed intended operation, but an informational warning is returned. For a description of the **code**, wire the error cluster to a LabVIEW error-handling VI, such as the Simple Error Handler.



**source** identifies the VI where the error occurred.

## Description

This VI stops communication so that you can change the configuration of the task, such as by using [CAN Set Property.vi](#) or [CAN Connect Terminals.vi](#). After you change the configuration, use [CAN Start.vi](#) to start again.

This VI does not clear the configuration for the task; therefore, do *not* use it as the last NI-CAN VI in the application. [CAN Clear.vi](#) must always be the last NI-CAN VI for each task.

## CAN Sync Start with NI-DAQ.vi

### Purpose

Synchronize and start the specified CAN task and NI-DAQ task.

### Format

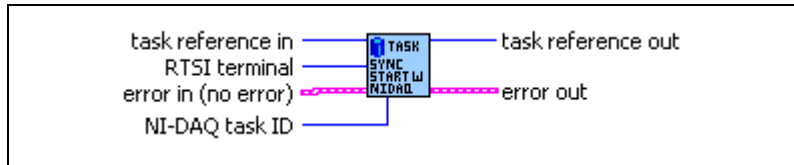

### Inputs



**task reference in** is the task reference from the previous NI-CAN VI. The task reference is originally returned from VIs such as [CAN Initialize.vi](#) or [CAN Create Message.vi](#).



**NI-DAQ task ID** is the task ID from an NI-DAQ configuration VI, such as [AI Config](#) or [AO Config](#).

When this VI returns, do not call an NI-DAQ start VI for the task. The LabVIEW diagram of this VI starts the **NI-DAQ task ID** for you, so you can immediately call NI-DAQ read or write VIs.



**RTSI terminal** specifies the RTSI terminal number to use for the shared start trigger. This input uses a ring typedef to select terminals from **RTSI0** to **RTSI6**.



**Error in** describes error conditions occurring before the VI executes. If an error has already occurred, the VI returns the value of the **Error in** cluster in **Error out**.



**status** is True if an error occurred. If **status** is True, the VI does not perform any operations.



**code** is the error code number identifying an error. A value of 0 means success. A negative value means error: VI did not execute the intended operation. A positive value means warning: VI executed intended operation, but an informational warning is returned. For a description of the **code**, wire the error cluster to a LabVIEW error-handling VI, such as the Simple Error Handler.



**source** identifies the VI where the error occurred.

## Outputs



**task reference out** is the same as **task reference in**. Wire the task reference to subsequent NI-CAN VIs for this task.



**Error out** describes error conditions. If the **Error in** cluster indicated an error, the **Error out** cluster contains the same information. Otherwise, **Error out** describes the error status of this VI.



**status** is True if an error occurred.



**code** is the error code number identifying an error. A value of 0 means success. A negative value means error: VI did not execute the intended operation. A positive value means warning: VI executed intended operation, but an informational warning is returned. For a description of the **code**, wire the error cluster to a LabVIEW error-handling VI, such as the Simple Error Handler.



**source** identifies the VI where the error occurred.

## Description

The CAN and NI-DAQ task execute on different NI hardware products. To use the input/output samples of these tasks together in the application, the NI hardware products must be synchronized with RTSI terminal connections. Both NI hardware products must use a common timebase to avoid clock drift, and a common start trigger to start input/output at the same time.

This VI uses NI-CAN and NI-DAQ RTSI functions to synchronize the NI hardware products to a common timebase and start trigger, and then it starts sampling on both tasks. The function used to connect RTSI terminals on the CAN card is [CAN Connect Terminals.vi](#).

When you use this VI to start the tasks, you must use [CAN Clear with NI-DAQ.vi](#) to clear the tasks.

This VI synchronizes a single CAN hardware product to a single NI-DAQ hardware product. To synchronize multiple CAN cards and/or multiple NI-DAQ cards, refer to [CAN Sync Start Multiple with NI-DAQ.vi](#).

This VI is intended to serve as an example. You can use the VI as is, but the LabVIEW diagram is commented so that you can use the VI as a starting point for more complex synchronization scenarios. Before you customize the LabVIEW diagram, save a copy of the VI for editing.

The diagram of this VI assumes that the NI-DAQ product is an E Series MIO device. If you are using a different NI hardware product, refer to the diagram as a starting point.

The diagram of this VI issues the start trigger immediately. To implement more complex triggering, such as using an AI trigger to start, refer to the diagram as a starting point.

## CAN Sync Start with NI-DAQmx.vi

### Purpose

Synchronize and start the specified CAN task and NI-DAQmx task.

### Format

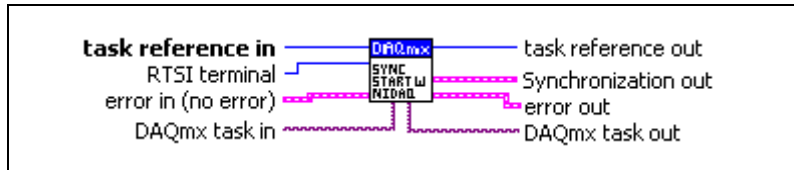

### Inputs



**task reference in** is the task reference from the previous NI-CAN VI. The task reference is originally returned from VIs such as **CAN Initialize.vi** or **CAN Create Message.vi**.



**NI-DAQmx task in** is the task ID from an NI-DAQmx configuration VI, such as **DAQmx Create Virtual Channel**. When this VI returns, do not call an **NI-DAQmx Start Task** VI for the task. The LabVIEW diagram of this VI starts the **NI-DAQmx task** for you, so you can immediately call NI-DAQmx read or write VIs.



**RTSI terminal** specifies the RTSI terminal number to use for the shared start trigger. This input uses a ring typedef to select terminals from **RTSI0** to **RTSI6**.



**Error in** describes error conditions occurring before the VI executes. If an error has already occurred, the VI returns the value of the **Error in** cluster in **Error out**.



**status** is True if an error occurred. If **status** is True, the VI does not perform any operations.



**code** is the error code number identifying an error. A value of 0 means success. A negative value means error: VI did not execute the intended operation. A positive value means warning: VI executed intended operation, but an informational warning is returned. For a description of the **code**, wire the error cluster to a LabVIEW error-handling VI, such as the Simple Error Handler.



**source** identifies the VI where the error occurred.

## Outputs



**task reference out** is the same as **task reference in**. Wire the task reference to subsequent NI-CAN VIs for this task.



**Synchronization out** defines a cluster with information about the signals that have been routed between the cards and about additional DAQmx tasks that may have been created for synchronization.



**Counter task out** is the task from an **NI-DAQmx Create Virtual Channel VI**. This additional NI-DAQmx task is created under certain circumstances to generate a common timebase clock for cards that do not support sharing of timebases through RTSI (like DAQ cards or NI-CAN Series 1 cards).



**Routes out** is a 1-dimensional array of terminal names of signals that have been routed between the cards.



**Source terminal** is the name of the terminal where the route starts.



**Destination terminal** is the name of the terminal where the route ends.



**Error out** describes error conditions. If the **Error in** cluster indicated an error, the **Error out** cluster contains the same information. Otherwise, **Error out** describes the error status of this VI.



**status** is True if an error occurred.



**code** is the error code number identifying an error. A value of 0 means success. A negative value means error: VI did not execute the intended operation. A positive value means warning: VI executed intended operation, but an informational warning is returned. For a description of the **code**, wire the error cluster to a LabVIEW error-handling VI, such as the Simple Error Handler.



**source** identifies the VI where the error occurred.

## Description

The CAN and NI-DAQmx tasks execute on different NI hardware products. To use the input/output samples of these tasks together in the application, the NI hardware products must be synchronized with RTSI terminal connections. Both NI hardware products must use a common timebase to avoid clock drift, and a common start trigger to start input/output at the same time.

This VI uses NI-CAN and NI-DAQmx RTSI functions to synchronize the NI hardware products to a common timebase and start trigger, and then it starts sampling on both tasks. The function used to connect RTSI terminals on the CAN card is [CAN Connect Terminals.vi](#).

When you use this VI to start the tasks, you must use [CAN Clear with NI-DAQmx.vi](#) to clear the tasks.

This VI synchronizes a single CAN hardware product to a single NI-DAQ hardware product. To synchronize multiple CAN cards and/or multiple NI-DAQ cards, refer to [CAN Sync Start with NI-DAQmx.vi](#).

This VI is intended to serve as an example. You can use the VI as is, but the LabVIEW diagram is commented so that you can use the VI as a starting point for more complex synchronization scenarios. Before you customize the LabVIEW diagram, save a copy of the VI for editing.

This VI is designed to support most E Series MIO devices and M Series MIO devices through NI-DAQmx. If you are using a different NI hardware product, refer to the diagram as a starting point.

The diagram of this VI issues the start trigger immediately. To implement more complex triggering, such as using an AI trigger to start, refer to the diagram as a starting point.

## CAN Sync Start Multiple with NI-DAQ.vi

### Purpose

Synchronize and start the specified list of multiple CAN tasks and a single NI-DAQ task. This is a more complex implementation of [CAN Sync Start with NI-DAQ.vi](#) that supports multiple CAN hardware products.

### Format

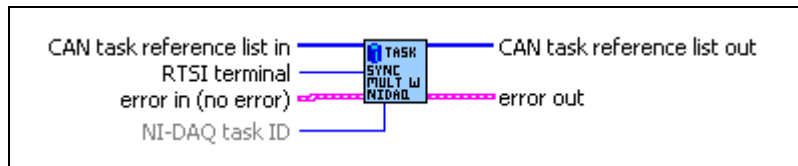

### Inputs

**[U32]**

**CAN task reference list in** is an array of NI-CAN task references. Each task reference is originally returned from VIs such as [CAN Initialize.vi](#) or [CAN Create Message.vi](#). You can build the task references into an array using the LabVIEW **Build Array** VI.

**[U32]**

**NI-DAQ task ID** list is a task ID originally returned from an NI-DAQ configuration VI, such as **AI Config** or **AO Config**. When this VI returns, do not call an NI-DAQ start VI. The LabVIEW diagram of this VI starts **NI-DAQ task ID** list for you, so you can immediately call NI-DAQ read or write VIs.

**[U32]**

**RTSI terminal** specifies the RTSI terminal number to use for the shared start trigger. This input uses a ring typedef to select terminals from **RTSI0** to **RTSI6**.

**[Err]**

**Error in** describes error conditions occurring before the VI executes. If an error has already occurred, the VI returns the value of the **Error in** cluster in **Error out**.

**[TF]**

**status** is True if an error occurred. If **status** is True, the VI does not perform any operations.

**[I32]**

**code** is the error code number identifying an error. A value of 0 means success. A negative value means error: VI did not execute the intended operation. A positive value means warning: VI executed intended operation, but an informational warning is



returned. For a description of the **code**, wire the error cluster to a LabVIEW error-handling VI, such as the Simple Error Handler.



**source** identifies the VI where the error occurred.

## Outputs



**CAN task reference list out** is the same as **CAN task reference list in**.



**Error out** describes error conditions. If the **Error in** cluster indicated an error, the **Error out** cluster contains the same information. Otherwise, **Error out** describes the error status of this VI.



**status** is True if an error occurred.



**code** is the error code number identifying an error. A value of 0 means success. A negative value means error: VI did not execute the intended operation. A positive value means warning: VI executed intended operation, but an informational warning is returned. For a description of the **code**, wire the error cluster to a LabVIEW error-handling VI, such as the Simple Error Handler.



**source** identifies the VI where the error occurred.

## Description

The CAN and NI-DAQ tasks execute on different NI hardware products. To use the input/output samples of these tasks together in the application, the NI hardware products must be synchronized with RTSI terminal connections. Both NI hardware products must use a common timebase to avoid clock drift, and a common start trigger to start input/output at the same time.

This VI uses NI-CAN and NI-DAQ RTSI functions to synchronize the NI hardware products to a common timebase and start trigger, and then it starts sampling on all tasks. The function used to connect RTSI terminals on the CAN card is [CAN Connect Terminals.vi](#).

When you use this VI to start the tasks, you must use [CAN Clear Multiple with NI-DAQ.vi](#) to clear the tasks.

This VI is intended to serve as an example. You can use the VI as is, but the LabVIEW diagram is commented so that you can use the VI as a starting point for more complex synchronization scenarios. Before you customize the LabVIEW diagram, save a copy of the VI for editing.

This VI does not demonstrate synchronization of multiple NI-DAQ hardware products. Refer to NI-DAQ for examples of synchronizing the timebase and trigger of multiple DAQ cards.

The diagram of this VI assumes that all NI-DAQ products are E Series MIO devices. If you are using a different NI hardware product, refer to the diagram as a starting point.

The diagram of this VI issues the start trigger immediately. To implement more complex triggering, such as using an AI trigger to start, refer to the diagram as a starting point.

## CAN Sync Start Multiple with NI-DAQmx.vi

### Purpose

Synchronize and start the specified list of multiple CAN tasks and a single NI-DAQmx task. This is a more complex implementation of [CAN Sync Start with NI-DAQmx.vi](#) that supports multiple CAN hardware products.

### Format

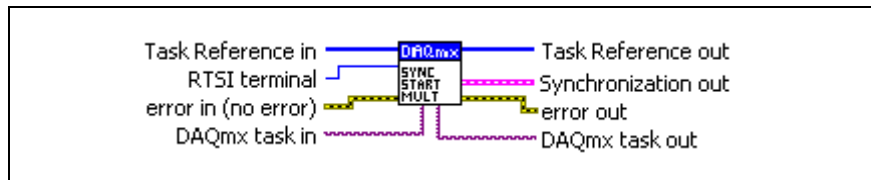

### Inputs

**U32**

**CAN task reference list in** is an array of NI-CAN task references. Each task reference is originally returned from VIs such as [CAN Initialize.vi](#) or [CAN Create Message.vi](#). You can build the task references into an array using the LabVIEW [Build Array](#) VI.

**U32**

**DAQmx task in** is the task from an NI-DAQmx configuration VI, such as [DAQmx Create Virtual Channel](#). When this VI returns, do not call an NI-DAQmx Start Task VI. The LabVIEW diagram of this VI starts the **NI-DAQmx task** for you, so you can immediately call NI-DAQmx read or write VIs.

**U32**

**RTSI terminal** specifies the RTSI terminal number to use for the shared start trigger. This input uses a ring typedef to select terminals from **RTSI0** to **RTSI6**.

**Err**

**Error in** describes error conditions occurring before the VI executes. If an error has already occurred, the VI returns the value of the **Error in** cluster in **Error out**.

**TF**

**status** is True if an error occurred. If **status** is True, the VI does not perform any operations.

**I32**

**code** is the error code number identifying an error. A value of 0 means success. A negative value means error: VI did not execute the intended operation. A positive value means warning: VI executed intended operation, but an informational warning is

returned. For a description of the **code**, wire the error cluster to a LabVIEW error-handling VI, such as the Simple Error Handler.

**source** identifies the VI where the error occurred.



## Outputs



**CAN task reference list out** is the same as **CAN task reference list in**.



**Synchronization out** defines a cluster with information about the signals that have been routed between the cards and about additional DAQmx tasks that may have been created for synchronization.



**Counter task out** is the task from an **NI-DAQmx Create Virtual Channel VI**. This additional NI-DAQmx task is created under certain circumstances to generate a common timebase clock for cards that do not support sharing of timebases through RTSI (like DAQ cards or NI-CAN Series 1 cards).



**Routes out** is a 1-dimensional array of terminal names of signals that have been routed between the cards.



**Source terminal** is the name of the terminal where the route starts.



**Destination terminal** is the name of the terminal where the route ends.



**Error out** describes error conditions. If the **Error in** cluster indicated an error, the **Error out** cluster contains the same information. Otherwise, **Error out** describes the error status of this VI.



**status** is True if an error occurred.



**code** is the error code number identifying an error. A value of 0 means success. A negative value means error: VI did not execute the intended operation. A positive value means warning: VI executed intended operation, but an informational warning is returned. For a description of the **code**, wire the error cluster to a LabVIEW error-handling VI, such as the Simple Error Handler.



**source** identifies the VI where the error occurred.

## Description

The CAN and NI-DAQmx tasks execute on different NI hardware products. To use the input/output samples of these tasks together in the application, the NI hardware products must be synchronized with RTSI terminal connections. Both NI hardware products must use a common timebase to avoid clock drift, and a common start trigger to start input/output at the same time.

This VI uses NI-CAN and NI-DAQmx RTSI functions to synchronize the NI hardware products to a common timebase and start trigger, and then it starts sampling on all tasks. The function used to connect RTSI terminals on the CAN card is [CAN Connect Terminals.vi](#).

When you use this VI to start the tasks, you must use [CAN Clear Multiple with NI-DAQmx.vi](#) to clear the tasks.

This VI is intended to serve as an example. You can use the VI as is, but the LabVIEW diagram is commented so that you can use the VI as a starting point for more complex synchronization scenarios. Before you customize the LabVIEW diagram, save a copy of the VI for editing.

This VI does not demonstrate synchronization of multiple NI-DAQmx hardware products. Refer to NI-DAQ for examples of synchronizing the timebase and trigger of multiple DAQ cards.

This VI is designed to support most E Series MIO devices and M Series MIO devices through NI-DAQmx. If you are using a different NI hardware product, refer to the diagram as a starting point.

The diagram of this VI issues the start trigger immediately. To implement more complex triggering, such as using an AI trigger to start, refer to the diagram as a starting point.

## CAN Write.vi

### Purpose

Write samples to a CAN task initialized as Output (refer to the **mode** parameter of [CAN Init Start.vi](#)). Samples are placed into transmitted CAN messages. The poly VI selection determines the data type to write.

To select the data type, right-click the VI, go to **Select Type**, and select the type by name.

For LabVIEW 7.0 and later, you can right-click the VI and select **Visible Items»Poly VI Selector** to select the data type from within the diagram.

For an overview of **CAN Write**, refer to the *Write* section of Chapter 6, *Using the Channel API*.

### Format

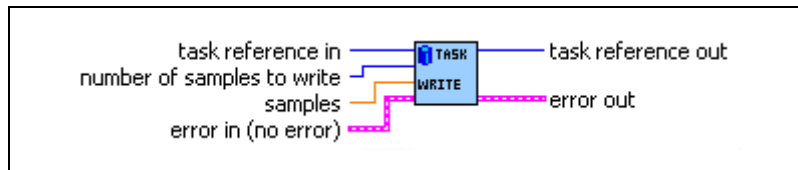

### Inputs



**task reference in** is the task reference from the previous NI-CAN VI. The task reference is originally returned from [CAN Init Start.vi](#), [CAN Initialize.vi](#), or [CAN Create Message.vi](#), and then wired through subsequent VIs.

The **mode** initialized for the task must be **Output**.



**number of samples to write** specifies the number of samples to write for the task. For single-sample Poly VI types, [CAN Write.vi](#) always accepts one sample, so this input is ignored.



The poly input **samples** specifies the samples to transmit in CAN messages. The poly input type is determined by the Poly VI selection. For information on the different poly VI types provided by [CAN Write.vi](#), refer to the *Poly VI Types* section in this function reference.

To select the data type, right-click the VI, go to **Select Type**, and select the type by name.



**Error in** describes error conditions occurring before the VI executes. If an error has already occurred, the VI returns the value of the **Error in** cluster in **Error out**.



**status** is True if an error occurred. If **status** is True, the VI does not perform any operations.



**code** is the error code number identifying an error. A value of 0 means success. A negative value means error: VI did not execute the intended operation. A positive value means warning: VI executed intended operation, but an informational warning is returned. For a description of the **code**, wire the error cluster to a LabVIEW error-handling VI, such as the Simple Error Handler.



**source** identifies the VI where the error occurred.

## Outputs



**task reference out** is the same as **task reference in**. Wire the task reference to subsequent VIs for this task.



**Error out** describes error conditions. If the **Error in** cluster indicated an error, the **Error out** cluster contains the same information. Otherwise, **Error out** describes the error status of this VI.



**status** is True if an error occurred.



**code** is the error code number identifying an error. A value of 0 means success. A negative value means error: VI did not execute the intended operation. A positive value means warning: VI executed intended operation, but an informational warning is returned. For a description of the **code**, wire the error cluster to a LabVIEW error-handling VI, such as the Simple Error Handler.



**source** identifies the VI where the error occurred.

## Poly VI Types

The name of each Poly VI type uses the following conventions:

- The first term is either **Single-Chan** or **Multi-Chan**. This indicates whether the type specifies data for a single channel or multiple channels. **Multi-Chan** types specify an array of analogous **Single-Chan** types, one entry for each channel initialized in **channel list** of **CAN Init Start.vi**. **Single-Chan** types are convenient because no array indexing is required, but you are limited to writing only one CAN channel.
- The second term is either **Single-Samp** or **Multi-Samp**. This indicates whether the type specifies a single sample, or an array of multiple samples. **Single-Samp** types are often

used for single-point control applications, such as within LabVIEW RT. Single-Samp types are required for the Output Recent mode.

- The third term indicates the data type used for each sample. The word *Dbf* indicates double-precision (64-bit) floating point. The word *Wfm* indicates the waveform data type. The words *1D* and *2D* indicate one and two-dimensional arrays, respectively.

## Single-Chan Single-Samp Dbf

Writes a single sample for the first channel initialized in **channel list**.

You can use this type with **Output** mode or **Output Recent** mode.

If the initialized sample rate is greater than zero, the task transmits a CAN message periodically at the specified rate. The first **CAN Write.vi** transmits a message immediately, and then begins a periodic timer at the specified rate. In **Output** mode, samples are queued and each subsequent message transmission uses the next available sample. When there are no more samples, the last sample is retransmitted until a new sample is provided or the task is stopped. In **Output Recent** mode, only the last provided sample is transmitted periodically, based on the timer.

If the initialized **sample rate** is zero, the message is transmitted immediately each time you call **CAN Write.vi**.

Because all channels of a message are transmitted on the network as a unit, **CAN Write.vi** enforces the following rules:

- You *cannot* write the same message in more than one **Output** task.
- You *can* write more than one message in a single **Output** task.
- You *can* write a subset of channels for a message in a single **Output** task. For channels that are not included in the task, the Default Value is transmitted in the CAN message. Because this Poly VI writes only one channel, the **Default Value** will always be used for any remaining channels in the associated message.

For many applications, the most straightforward technique is to assign a single task for each message you want to transmit. In each task, include all channels of that message in the **channel list**. This ensures that you can provide new samples for the entire message with each **CAN Write.vi**.

## Multi-Chan Single-Samp 1D Dbf

Writes an array, one entry for each channel initialized in **channel list**. Each entry consists of a single sample.

You can use this type with **Output** mode or **Output Recent** mode.



The messages transmitted by **CAN Write.vi** are determined by the associated **channel list**. If all channels are contained in a single message, only that message is transmitted. If a few channels are contained in one message, and the remaining channels are contained in a second message, two messages are transmitted.

If the initialized sample rate is greater than zero, the task transmits associated CAN messages periodically at the specified rate. The first **CAN Write.vi** transmits messages immediately, and then begins a periodic timer at the specified rate. In **Output** mode, samples are queued and each subsequent message transmission uses the next available sample. When there are no more samples, the last sample is retransmitted until a new sample is provided or the task is stopped. In **Output Recent** mode, only the last provided sample is transmitted periodically, based on the timer.

If the initialized **sample rate** is zero, the messages are transmitted immediately each time you call **CAN Write.vi**.

Because all channels of a message are transmitted on the network as a unit, **CAN Write.vi** enforces the following rules:

- You *cannot* write the same message in more than one task.
- You *can* write more than one message in a single task.
- You *can* write a subset of channels for a message in a single task. For channels that are not included in the task, the Default Value is transmitted in the CAN message.

For many applications, the most straightforward technique is to assign a single task for each message that you want to transmit. In each task, include all channels of that message in the **channel list**. This ensures that you can provide new samples for the entire message with each **CAN Write.vi**.

## Single-Chan Multi-Samp 1D Db1

Writes an array of samples for the first channel initialized in **channel list**.

You can use this type with **Output** mode only (not **Output Recent** mode).

If the initialized sample rate is greater than zero, the task transmits a CAN message periodically at the specified rate. This Poly VI is used to transmit a sequence of messages periodically, with a unique sample value in each message. The first **CAN Write.vi** transmits a message immediately using the first sample in the array, and then begins a periodic timer at the specified rate. Each subsequent message transmission is based on the timer, and uses the next sample in the array. After the final sample in the array has been transmitted, subsequent behavior is determined by the **Behavior After Final Output** property. The default **Behavior After Final Output** is to retransmit the final sample each period until **CAN Write.vi** is called again.

If the initialized **sample rate** is zero, a message is transmitted immediately for each entry in the array, with as little delay as possible between messages. After the message for the final sample is transmitted, no further transmissions occur until **CAN Write.vi** is called again, regardless of the **Behavior After Final Output** property.

Because all channels of a message are transmitted on the network as a unit, **CAN Write.vi** enforces the following rules:

- You *cannot* write the same message in more than one task.
- You *can* write more than one message in a single task.
- You *can* write a subset of channels for a message in a single task. For channels that are not included in the task, the Default Value is transmitted in the CAN message. Because this Poly VI writes only one channel, the **Default Value** will always be used for any remaining channels in the associated message.

For many applications, the most straightforward technique is to assign a single task for each message that you want to transmit. In each task, include all channels of that message in the **channel list**. This ensures that you can provide new samples for the entire message with each **CAN Write.vi**.

## Multi-Chan Multi-Samp 2D Dbl

Writes an array, one entry for each channel initialized in **channel list**. Each entry consists of an array of samples.

You can use this type with **Output** mode only (not **Output Recent** mode).

The messages transmitted by **CAN Write.vi** are determined by the associated **channel list**. If all channels are contained in a single message, only that message is transmitted. If a few channels are contained in one message, and the remaining channels are contained in a second message, two messages are transmitted.

If the initialized sample rate is greater than zero, the task transmits associated CAN messages periodically at the specified rate. This Poly VI is used to transmit a sequence of messages periodically, with unique sample values in each set of messages. The first **CAN Write.vi** transmits associated messages immediately using the first sample in the array of each channel, and then begins a periodic timer at the specified rate. Each subsequent transmission of messages is based on the timer, and uses the next sample in the array of each channel. After the final sample in the array of each channel has been transmitted, subsequent behavior is determined by the **Behavior After Final Output** property. The default **Behavior After Final Output** is to retransmit the final sample each period until **CAN Write.vi** is called again.

If the initialized **sample rate** is zero, the task transmits associated messages immediately for each entry in the array of each channel, with as little delay as possible between messages.

After the message for the final sample is transmitted, no further transmissions occur until **CAN Write.vi** is called again, regardless of the **Behavior After Final Output** property.

Because all channels of a message are transmitted on the network as a unit, **CAN Write.vi** enforces the following rules:

- You *cannot* write the same message in more than one task.
- You *can* write more than one message in a single task.
- You *can* write a subset of channels for a message in a single task. For channels that are not included in the task, the Default Value is transmitted in the CAN message.

For many applications, the most straightforward technique is to assign a single task for each message that you want to transmit. In each task, include all channels of that message in the **channel list**. This ensures that you can provide new samples for the entire message with each **CAN Write.vi**.

### Single-Chan Multi-Samp Wfm

Writes a single waveform for the first channel initialized in **channel list**.

The *start time* and *delta time* of the waveform does not affect the beginning of message transmission. Therefore, this Poly VI type is equivalent to the **Single-Chan Multi-Samp 1D Dbl** Poly VI type.

### Multi-Chan Multi-Samp 1D Wfm

Writes an array, one entry for each channel initialized in **channel list**. Each entry consists of a single waveform.

The *start time* and *delta time* of each waveform does not affect the beginning of message transmission. Therefore, this Poly VI type is equivalent to the **Multi-Chan Multi-Samp 2D Dbl** Poly VI type.

---

# Channel API for C

This chapter lists the NI-CAN functions and describes the format, purpose and parameters.

Unless otherwise stated, each NI-CAN function suspends execution of the calling thread until it completes. The functions in this chapter are listed alphabetically.

## Section Headings

---

The following are section headings found in the Channel API for C functions.

### Purpose

Each function description includes a brief statement of the purpose of the function.

### Format

The format section describes the format of each function for the C programming language.

### Input and Output

The input and output parameters for each function are listed.

### Description

The description section gives details about the purpose and effect of each function.

## Data Types

---

The following data types are used with functions of the NI-CAN Channel API for C.

**Table 8-1.** NI-CAN Channel API for C Data Types

Data Type	Purpose
i8	8-bit signed integer.
i16	16-bit signed integer.
i32	32-bit signed integer.
u8	8-bit unsigned integer.

**Table 8-1.** NI-CAN Channel API for C Data Types (Continued)

<b>Data Type</b>	<b>Purpose</b>
u16	16-bit unsigned integer.
u32	32-bit unsigned integer.
f32	32-bit floating-point number.
f64	64-bit floating-point number.
str	ASCII string represented as an array of characters terminated by null character ('\0'). This type is used with output strings.
cstr	ASCII string represented as an array of characters terminated by null character ('\0'). This type is used with input strings.
nctTypeTaskRef	Reference to an initialized task. Refer to <a href="#">nctInitStart</a> for more information.
nctTypeStatus	Status returned from NI-CAN functions. Refer to <a href="#">ncStatusToString</a> in the Frame API for more information.
nctTypeTimestamp	Timestamp. Refer to <a href="#">nctReadTimestamped</a> for more information.

## List of Functions

Table 8-1 contains an alphabetical list of the NI-CAN Channel API for C functions.

**Table 8-2.** NI-CAN Channel API for C Functions

<b>Function</b>	<b>Purpose</b>
<a href="#">nctClear</a>	Stops communication for the task and then clears the configuration.
<a href="#">nctConnectTerminals</a>	Connects terminals in the CAN hardware.
<a href="#">nctCreateMessage</a>	Creates a message configuration and associated channel configurations within the application.

**Table 8-2.** NI-CAN Channel API for C Functions (Continued)

Function	Purpose
<code>nctCreateMessageEx</code>	Creates a message configuration and associated channel configurations within the application. <code>nctCreateMessageEx</code> allows you to create normal CAN channels and mode dependent channels. For more information about mode dependent channels, refer to the <i>Mode Dependent Channels</i> section of Chapter 6, <i>Using the Channel API</i> .
<code>nctDisconnectTerminals</code>	Disconnects terminals in the CAN hardware.
<code>nctGetNames</code>	Gets an array of CAN channel names or message names from MAX or a CAN database file.
<code>nctGetNamesLength</code>	Gets the required size for a specified list of channels to allocate an array for the <code>ChannelList</code> input of <code>nctGetNames</code> .
<code>nctGetProperty</code>	Gets a property for the task, or a single channel within the task.
<code>nctInitialize</code>	Initializes a task for the specified channel list.
<code>nctInitStart</code>	Initializes a task for the specified channel list, then start communication.
<code>nctRead</code>	Reads samples from a CAN task initialized with a <code>Mode</code> of <code>nctModeInput</code> . Samples are obtained from received CAN messages.
<code>nctReadTimestamped</code>	Reads samples from a CAN task initialized with a <code>Mode</code> of <code>nctModeTimestampedInput</code> .
<code>nctSetProperty</code>	Sets a property for the task, or a single channel within the task.
<code>nctStart</code>	Starts communication for the specified task.
<code>nctStop</code>	Stops communication for the specified task.
<code>nctWrite</code>	Writes samples to a CAN task initialized as <code>nctModeOutput</code> . Samples are placed into transmitted CAN messages.

## nctClear

---

### Purpose

Stops communication for the task and then clears the configuration.

### Format

```
nctTypeStatus nctClear( nctTypeTaskRef TaskRef );
```

### Inputs

TaskRef

Task reference from the previous NI-CAN function. The task reference is originally returned from [nctInitStart](#), [nctInitialize](#), or [nctCreateMessage](#).

### Outputs

#### Return Value

The return value indicates the status of the function call as a signed 32-bit integer. Zero means the function executed successfully. A negative value specifies an error, which means the function did not perform the expected behavior. A positive value specifies a warning, which means the function performed as expected, but a condition arose that may require attention.

Use the [ncStatusToString](#) function of the Frame API to obtain a descriptive string for the return value. The [ncStatusToString](#) and [ncGetHardwareInfo](#) functions are the only Frame API functions that can be called within a Channel API application.

### Description

The `nctClear` function must always be the final NI-CAN function called for each task. If you do not use the `nctClear` function, the remaining task configurations can cause problems in execution of subsequent NI-CAN applications.

If the cleared task is the last running task for the initialized `Interface` (refer to [nctInitStart](#) for more information), the `nctClear` function also stops communication on the CAN controller of the interface and disconnects all terminal connections for that interface.

Because this function clears the task, `TaskRef` cannot be used with subsequent functions. To change the properties of a running task, use [nctStop](#) to stop the task, [nctSetProperty](#) to change the desired property, and then [nctStart](#) to restart the task.

## nctConnectTerminals

---

### Purpose

Connects terminals in the CAN hardware.

### Format

```
nctTypeStatus  nctConnectTerminals(
                nctTypeTaskRef  TaskRef,
                u32              SourceTerminal,
                u32              DestinationTerminal,
                u32              Modifiers);
```

### Inputs

TaskRef

Task reference from the previous NI-CAN function. The task reference is originally returned from `nctInitStart`, `nctInitialize`, or `nctCreateMessage`.

SourceTerminal

Specifies the connection source.

Once the connection is successfully created, behavior flows from SourceTerminal to DestinationTerminal.

For a list of valid source/destination pairs, refer to the [Valid Combinations of Source/Destination](#) section in this function reference.

The following list describes each value of SourceTerminal:

`nctSrcTermRTSI0... nctSrcTermRTSI6`

Selects a general-purpose RTSI line as source (input) of the connection.

`nctSrcTermRTSI_Clock`

Selects the RTSI clock line as source (input) of the connection. This terminal is also RTSI line 7. RTSI7 is dedicated for routing of a timebase (10 MHz or 20 MHz)

The only valid DestinationTerminal for this source is `nctDestTermMasterTimebase`.



For PCI and PXI form factors, this receives a 20 MHz (default) timebase from another CAN or DAQ card. For example, you can synchronize a CAN and DAQ E Series MIO card by connecting the 20 MHz oscillator (board clock) of the DAQ card to `nctSrcTermRTSI_Clock`, and then connecting `nctSrcTermRTSI_Clock` to `nctDestTermMasterTimebase` on the CAN card.

For PCMCIA form factor, a 10 MHz timebase is required on `nctSrcTermRTSI_Clock`. For synchronization with a PCMCIA DAQ card, this is done by programming the `FREQOUT` signal of the DAQ card to 10 MHz, then wiring `FREQOUT` to the `nctSrcTermRTSI_Clock` of the CAN card.

This value applies to Series 2 cards only (returns error for Series 1).

`nctSrcTermPXI_Star`

`nctSrcTermPXI_Star` selects the PXI star trigger signal.

Within a PXI chassis, some PXI products can source star trigger from Slot 2 to all higher-numbered slots.

`PXI_Star` enables the PXI CAN card to receive the star trigger when it is in Slot 3 or higher.

This value applies to Series 2 PXI CAN cards only. If you are using a Series 1 CAN card or Series 2 PCI or PCMCIA CAN card, selecting this value results in an error.

`nctSrcTermPXI_Clk10`

`nctSrcTermPXI_Clk10` selects the PXI 10 MHz backplane clock.

The only valid `DestinationTerminal` for this source is `nctDestTermMasterTimebase`. This routes the 10 MHz PXI backplane clock for use as the timebase for the CAN card. When you use `PXI_Clk10` as the timebase for the CAN card, you must also use `PXI_Clk10` as the timebase for other PXI cards to perform synchronized input/output.

This value applies to Series 2 PXI CAN cards only. If you are using a Series 1 CAN card or Series 2 PCI or PCMCIA CAN card, selecting this value results in an error.

`nctSrcTerm20MHzTimebase`

`nctSrcTerm20MHzTimebase` selects the 20 MHz oscillator of the CAN card.

The only valid `DestinationTerminal` for this source is `nctDestTermRTSI_Clock`. This routes the 20 MHz clock of the CAN card for use as a timebase by other NI cards. For example, you can synchronize two CAN cards by connecting `nctSrcTerm20MHzTimebase` to `nctDestTermRTSI_CLOCK` on one CAN card, and then connecting `nctSrcTermRTSI_CLOCK` to `nctDestTermMasterTimebase` on the other CAN card. `nctSrcTerm20MHzTimebase` applies to the entire CAN card, including both interfaces of a 2-port CAN card. The CAN card is specified by the task interface, such as the `Interface` input to `nctInitialize`.

This value applies to Series 2 PXI or PCI CAN cards only. If you are using a Series 1 CAN card or Series 2 PCMCIA CAN card, selecting this value results in an error.

`nctSrcTerm10HzResyncClock`

`nctSrcTerm10HzResyncClock` selects a 10 Hz, 50 percent duty cycle clock. This slow rate is required for resynchronization of CAN cards. On each pulse of the resync clock, the other CAN card brings its clock into sync.

By selecting `RTSI0-RTSI6` as the `DestinationTerminal`, you route the 10 Hz clock to synchronize with other CAN cards. NI DAQ cards cannot use the 10 Hz resync clock, so this selection is limited to synchronization of two or more CAN cards.

`nctSrcTerm10HzResyncClock` applies to the entire CAN card, including both interfaces of a 2-port CAN card. The CAN card is specified by the task interface, such as the `Interface` input to `nctInitialize`.

This value is typically used with Series 1 CAN cards only. If all of the CAN cards are Series 2, the 20 MHz timebase is preferable due to the lack of drift. If you are using a mix of Series 1 and Series 2 CAN cards, you must use `nctSrcTerm10HzResyncClock`.

`nctSrcTermIntfReceiveEvent`

`nctSrcTermIntfReceiveEvent` selects the dedicated receive interrupt output on the Philips SJA1000 CAN controller. When a received frame successfully passes the acceptance filter, a pulse with the width of one bit time is output during the last bit of the end of frame position of the CAN frame. Incoming CAN frames can be filtered using the

`nctPropIntfSeries2FilterMode` property. The CAN controller is specified by the task interface, such as the Interface input to `nctInitialize`.

`nctSrcTermIntfReceiveEvent` can be used as the start trigger for other NI cards, or for external instruments.

Since this value requires the Philips SJA1000 CAN controller, it applies to Series 2 CAN cards only. If you are using a Series 1 CAN card, selecting this value results in an error.

`nctSrcTermIntfTransceiverEvent`

`nctSrcTermIntfTransceiverEvent` selects the NERR signal from the CAN transceiver. The Low-Speed/Fault-Tolerant transceiver and the High-Speed transceiver provide the NERR signal. This signal asserts when a fault is detected by the transceiver. The default value of NERR is logic-high, which indicates no error.

The CAN controller is specified by the task interface, such as the Interface input to `nctInitialize`.

This value applies to Series 2 CAN cards only. If you are using a Series 1 CAN card, selecting this value results in an error.

`nctSrcTermStartTrigger`

`nctSrcTermStartTrigger` selects the start trigger, the event that begins sampling for tasks.

The start trigger is the same for all tasks using a given interface, such as the Interface input to `nctInitialize`.

In the default (disconnected) state of the `nctDestTermStartTrigger` destination, the start trigger occurs when communication begins on the interface.

By selecting RTSI0-RTSI6 as the `DestinationTerminal`, you route the start trigger of this CAN card to the start trigger of other CAN or DAQ cards. This ensures that sampling begins at the same time on both cards. For example, you can synchronize two CAN cards by routing

`nctSrcTermStartTrigger` as the `SourceTerminal` on one CAN card, and then routing

`nctDestTermStartTrigger` as the

`DestinationTerminal` on the other CAN card, with both cards using the same RTSI line for the connections.

`DestinationTerminal`

Specifies the destination of the connection.

The following list describes each value of `DestinationTerminal`:

`nctDestTermRTSI0... nctDestTermRTSI6`

Selects a general-purpose RTSI line as destination (output) of the connection.

`nctDestTermRTSI_Clock`

Selects the RTSI clock line as destination (output) of the connection. This terminal is also RTSI line 7. RTSI7 is dedicated for routing of a timebase. The CAN card can import a 10 MHz or 20 MHz timebase, but can only export a 20 MHz timebase. The only valid `SourceTerminal` for this source is `nctSrcTerm20MHzTimebase`.

This value applies to Series 2 CAN cards only. If you are using a Series 1 CAN card, selecting this value results in an error.

`nctDestTermMasterTimebase`

`nctDestTermMasterTimebase` instructs the CAN card to use the source of the connection as the master timebase. The CAN card uses this master timebase for input sampling (including timestamps of received messages) as well as periodic output sampling.

For PCI and PXI form factors, you can use

`nctSrcTermRTSI_Clock` as the `SourceTerminal`. By default this receives a 20 MHz timebase from another CAN or DAQ card. For example, you can synchronize a CAN and DAQ E Series MIO card by connecting the 20 MHz oscillator (board clock) of the DAQ card to `RTSI_Clock` (RTSI7), and then connecting `nctSrcTermRTSI_Clock` to `nctDestTermMasterTimebase` on the CAN card. To change the Master Timebase Rate to 10 MHz, use [nctSetProperty](#) to change the `nctPropHwMasterTimebaseRate`.

For PXI form factor, you also can use

`nctSrcTermPXI_Clk10` as the `SourceTerminal`. This receives the PXI 10 MHz backplane clock for use as the master timebase.

For PCMCIA form factor, you can use

`nctSrcTermRTSI_Clock` as the `SourceTerminal`. Unlike PCI and PXI, the PCMCIA CAN card requires a 10 MHz

timebase on `nctSrcTermRTSI_Clock` (TRIG7\_CLK). For synchronization with a PCMCIA DAQ card, this is done by programming the `FREQOUT` signal of the DAQ card to 10 MHz, then wiring `FREQOUT` to the `nctSrcTermRTSI_Clock` of the CAN card.

`nctDestTermMasterTimebase` applies to the entire CAN card, including both interfaces of a 2-port CAN card. The CAN card is specified by the task interface, such as the `Interface` input to `nctInitialize`.

The default (disconnected) state of this destination means the CAN card uses its local 20 MHz timebase as the master timebase.

This value applies to Series 2 CAN cards only. If you are using a Series 1 CAN card, selecting this value results in an error.

`nctDestTerm10HzResyncClock`

`nctDestTerm10HzResyncClock` instructs the CAN card to use a 10 Hz, 50 percent duty cycle clock to resynchronize its local timebase. This slow rate is required for resynchronization of CAN cards. On each low-to-high transition of the resync clock, this CAN card brings its local timebase into sync.

When synchronizing to an E Series MIO card, a typical use of this value is to use `RTSI0-RTSI6` as the `SourceTerminal`, then use NI-DAQ functions to program Counter 0 of the MIO card to generate a 10 Hz 50 percent duty cycle clock on the `RTSI` line.

When synchronizing to a CAN card, a typical use of this value is to use `RTSI0-RTSI6` as the `SourceTerminal`, then route the `nctSrcTerm10HzResyncClock` of the other CAN card as the `SourceTerminal` to the same `RTSI` line.

`nctDestTerm10HzResyncClock` applies to the entire CAN card, including both interfaces of a 2-port CAN card. The CAN card is specified by the task interface, such as the `Interface` input to `nctInitialize`.

The default (disconnected) state of this destination means the CAN card does not resynchronize its local timebase.

This value is typically used with Series 1 CAN cards only. If all of the CAN cards are Series 2, the 20 MHz timebase is preferable due to the lack of drift. If you are using a mix of

Series 1 and Series 2 CAN cards, you must use `nctSrcTerm10HzResyncClock`.

`nctDestTermStartTrigger`

`nctDestTermStartTrigger` selects the start trigger, the event that begins sampling for tasks. The start trigger occurs on the first low-to-high transition of the source terminal.

The start trigger is the same for all tasks using a given interface, such as the `Interface` input to `nctInitialize`.

By selecting `RTSI0-RTSI6`, or `nctSrcTermPXI_Star` for PXI hardware, as the `SourceTerminal`, you route the start trigger from another CAN or DAQ card. This ensures that sampling begins at the same time on both cards. For example, you can synchronize with an E Series DAQ MIO card by routing the AI start trigger of the MIO card to a RTSI line and then routing the same RTSI line with `nctDestTermStartTrigger` as the `DestinationTerminal` on the CAN card.

The default (disconnected) state of this destination means the start trigger occurs when communication begins on the interface. Because communication begins when the first task of the interface is started, this does not synchronize sampling with other NI cards.

#### Modifiers

Provides optional connection information for certain source/destination pairs. The current release of NI-CAN does not use this information for any source/destination pair, so you must pass `Modifiers` as zero.

## Outputs

### Return Value

The return value indicates the status of the function call as a signed 32-bit integer. Zero means the function executed successfully. A negative value specifies an error, which means the function did not perform the expected behavior. A positive value specifies a warning, which means the function performed as expected, but a condition arose that may require attention. Use the `ncStatusToString` function of the Frame API to obtain a descriptive string for the return value. The `ncStatusToString` and `ncGetHardwareInfo` functions are the only Frame API functions that can be called within a Channel API application.

## Description

This VI connects a specific pair of source/destination terminals. One of the terminals is typically a RTSI signal, and the other terminal is an internal terminal in the CAN hardware. By connecting internal terminals to RTSI, you can synchronize the CAN card with another hardware product such as an NI-DAQ or NI-DAQmx card.

The most common uses of RTSI synchronization are demonstrated by the CAN/DAQ programming examples.

When the final task for a given interface is cleared with `nctClear`, NI-CAN disconnects all terminal connections for that interface. Therefore, the `nctDisconnectTerminals` function is not required for most applications. NI-DAQ and NI-DAQmx terminals remain connected after the tasks are cleared, so you must disconnect NI-DAQ/NI-DAQmx terminals manually at the end of the application.

For a list of valid source/destination pairs, refer to the following section.

## Valid Combinations of Source/Destination

Table 8-3, *Valid combinations of Source/Destination*, lists all valid combinations of `SourceTerminal` and `DestinationTerminal`.

The series of the NI CAN hardware determines what combinations of `SourceTerminal` to `DestinationTerminal` are valid. Within the table, 1 indicates Series 1 hardware, and 2 indicates Series 2 hardware. You can determine the series of the NI CAN hardware by selecting the name of the card within the **Devices and Interfaces»NI-CAN Devices** view in the left pane of MAX.

Series 1 hardware has the following limitations:

- PXI cards do not support RTSI 6.
- Signals received from a RTSI source cannot occur faster than 1 kHz. This prevents the card from receiving a 10 MHz or 20 MHz timebase, such as provided by NI E Series MIO hardware.
- Signals received from a RTSI source must be at least 100  $\mu$ s in length to be detected. This prevents the card from receiving triggers in the nanoseconds range, such as the AI trigger provided by NI E Series MIO hardware. Series 2 CAN cards also send RTSI pulses in the nanoseconds range, so Series 1 CAN cards cannot receive RTSI input from Series 2 CAN cards.
- For CAN cards with High-Speed (HS) ports only, four RTSI signals are available for input (source), and four RTSI signals are available for output (destination). This limitation applies to the number of signals per direction, not the RTSI signal number. For example, if you connect RTSI0, RTSI1, RTSI3, and RTSI5 as input, connecting RTSI4 as input will return an error.

- For CAN cards with one or more Low-Speed (LS) ports, two RTSI signals are available for input (source), and three RTSI signals are available for output (destination).

Series 2 hardware has the following limitations:

- For all form factors (PCI, PXI, PCMCIA), the connection of Interface Transceiver Event to a RTSI destination is dependent on the physical port location. If the interface is located on Port 1, you can connect to even-numbered RTSI lines only (RTSI0, RTSI2, RTSI4, RTSI6). If the interface is located on Port 2, you can connect to odd-numbered RTSI lines only (RTSI1, RTSI3, RTSI5). You can determine the location by selecting the name of the interface in MAX.
- PCI cards do not support the PXI\_Star and PXI\_Clk10 terminals, as those signals exist on the PXI backplane.
- PCMCIA cards do not support the 20 MHz Timebase, PXI\_Star, and PXI\_Clk10 terminals. Because 20 MHz Timebase is not supported, you cannot synchronize the timebases of two PCMCIA CAN cards.
- On PCMCIA cards, RTSI4, RTSI5 and RTSI6 are not available.

**Table 8-3.** Valid combinations of Source/Destination

Source	Destination				
	RTSI0 to RTSI6	RTSI_Clock	Master Timebase	10 Hz Resync Clock	Start Trigger
RTSI0 to RTSI6	—	—	—	1, 2	1, 2
RTSI_Clock	—	—	2	—	—
PXI_Star	—	—	—	—	2
PXI_Clk10	—	—	2	—	—
20 MHz Timebase	—	2	—	—	—
10 Hz Resync Clock	1, 2	—	—	—	1, 2
Interface Receive Event	2	—	—	—	2



**Table 8-3.** Valid combinations of Source/Destination (Continued)

Source	Destination				
	RTSI0 to RTSI6	RTSI_Clock	Master Timebase	10 Hz Resync Clock	Start Trigger
Interface Transceiver Event	2	—	—	—	—
Start Trigger	1, 2	—	—	—	—

1—Valid connection for Series 1 hardware

2—Valid connection for Series 2 hardware

## nctCreateMessage

---

### Purpose

Creates a message configuration and associated channel configurations within the application.

### Format

```
nctTypeStatus nctCreateMessage (
    nctTypeMessageConfig MessageConfig,
    u32 NumberOfChannels,
    nctTypeChannelConfig *ChannelConfigList,
    i32 Interface,
    i32 Mode,
    f64 SampleRate,
    nctTypeTaskRef *TaskRef)
```

### Inputs

#### MessageConfig

Configures properties for a new message. This function creates a task for a single message with one or more channels. You provide the properties in a C struct.

The properties are similar to the message properties in MAX:

u32 MsgArbitrationID

Configures the arbitration ID of the message.

Use the `Extended Boolean` to specify whether the ID is standard (11-bit) or extended (29-bit).

u32 Extended

Configures a Boolean value that indicates whether the message arbitration ID is standard 11-bit format (0) or extended 29-bit format (1).

u32 MsgDataBytes

Configures the number of data bytes in the message. The range is 0 to 8.

`NumberOfChannels`

Specifies the number of channel configurations you provide in `ChannelConfigList`.

`ChannelConfigList`

Configures the list of channels for the new message.

`ChannelConfigList` is an array of a C struct, with one C struct for each channel.

The properties of each channel are similar to the channel properties in MAX:

`u32 StartBit`

Configures the starting bit position in the message. The range is 0 (lowest bit in first byte), to 63 (highest bit in last byte).

`u32 NumBits`

Configures the number of bits in the message. The range is 1 to 64.

`u32 DataType`

Configures the data type of the channel in the message. Values are `nctDataSigned`, `nctDataUnsigned`, and `nctDataFloat`.

`u32 ByteOrder`

Configures the byte order of the channel in the message. Values are `nctOrderIntel` (little-endian), and `nctOrderMotorola` (big-endian).

`f64 ScalingFactor`

Configures the scaling factor used to convert raw bits of the message to/from scaled floating-point units. The scaling factor is the  $A$  in the linear scaling formula  $AX+B$ , where  $X$  is the raw data, and  $B$  is the scaling offset.

`f64 ScalingOffset`

Configures the scaling offset used to convert raw bits of the message to/from scaled floating-point units. The scaling offset is the  $B$  in the linear scaling formula  $AX+B$ , where  $X$  is the raw data, and  $A$  is the scaling factor.

`f64 MaxValue`

Configures the maximum value of the channel in scaled floating-point units.

The `nctRead` and `nctWrite` functions do not coerce samples when converting to/from CAN messages. You can

use this value with the user-interface functions of the development environment to set the range of front-panel controls and indicators.

f64 MinValue

Configures the minimum value of the channel in scaled floating-point units.

The `nctRead` and `nctWrite` functions do not coerce samples when converting to/from CAN messages. You can use this value with the user-interface functions of the development environment to set the range of front-panel controls and indicators.

f64 DefaultValue

Configures the default value of the channel in scaled floating-point units.

For information on how the `DefaultValue` is used, refer to the `nctRead` and `nctWrite` functions.

const str Unit

Configures the unit string of the channel. The string is no more than 64 characters in length.

You can use this value to display units (such as volts or RPM) along with the samples of the channel.

Interface

Specifies the CAN interface to use for this task.

The interface input uses an enumeration in which value 0 selects `CAN0`, value 1 selects `CAN1`, and so on.

The default baud rate for the `Interface` is defined within `MAX`, but you can change it by setting the `nctPropIntfBaudRate` property with `nctSetProperty`.

The special interface values 256 and 257 refer to virtual interfaces. For more information on usage of virtual interfaces, refer to the *Frame to Channel Conversion* section of Chapter 6, *Using the Channel API*.

Mode

Specifies the I/O mode for the task. For an overview of the I/O modes, including figures, refer to the *Channel API Basic Programming Model* section of Chapter 6, *Using the Channel API*.

nctModeInput

Input channel data from received CAN messages. Use the `nctRead` function to obtain input samples as single-point, array,

or waveform. Each sample value that you write is transmitted in a message on the network. If you write an array or waveform, the samples are buffered for subsequent transmit.

Use this input mode to read waveforms of timed samples, such as for comparison with NI-DAQ or NI-DAQmx waveforms. You also can use this input mode to read a single point from the most recent message, such as for control or simulation.

#### `nctModeOutput`

Output channel data to CAN messages for transmit. Use the `nctWrite` function to write output samples as single-point, array, or waveform.

#### `nctModeOutputRecent`

Output channel data to CAN messages for transmit. This mode is used with sample rate greater than zero (periodic transmit). Use `nctWrite` to provide a single sample per channel. Each periodic message uses the sample values from the most recent `nctWrite`.

For this mode, there are restrictions on using channels in channel list that are contained in multiple messages. Refer to `nctWrite` for more information.

#### `nctModeTimestampedInput`

Input channel data from received CAN messages. Use the `nctRead` function to obtain input samples as an array of sample/timestamp pairs (refer to `nctReadTimestamped` for more information).

Use this input mode to read samples with timestamps that indicate when each message is received from the network.

#### `SampleRate`

Specifies the timing to use for samples of the task. The sample rate is specified in Hertz (samples per second). A sample rate of zero means to sample immediately.

For Mode of `NctModeInput`, `SampleRate` of zero means `nctRead` returns a single point from the most recent message received, and greater than zero means `nctRead` returns samples timed at the specified rate.

For Mode of `NctModeOutput`, `SampleRate` of zero means CAN messages transmit immediately when `nctWrite` is called, and greater than zero means CAN messages are transmitted periodically at the specified rate.

For mode of `nctModeOutputRecent`, `SampleRate` must be greater than zero (periodic transmit).

For Mode of `NctModeTimestampedInput`, `SampleRate` is ignored.

When the Interface specifies a virtual interface (256 or 257), and Mode is `nctModeOutput` or `nctModeOutputRecent`, this `SampleRate` must be zero (greater than zero not supported).

## Outputs

`TaskRef`

Use `TaskRef` with all subsequent functions to reference the task. Pass this task reference to `nctStart` before you read or write samples for the message.

## Return Value

The return value indicates the status of the function call as a signed 32-bit integer. Zero means the function executed successfully. A negative value specifies an error, which means the function did not perform the expected behavior. A positive value specifies a warning, which means the function performed as expected, but a condition arose that may require attention.

Use the `ncStatusToString` function of the Frame API to obtain a descriptive string for the return value. The `ncStatusToString` and `ncGetHardwareInfo` functions are the only Frame API functions that can be called within a Channel API application.

## Description

To use message and channel configurations from MAX or a CAN database, use the `nctInitStart` or `nctInitialize` functions. The `nctCreateMessage` function provides an alternative in which you create the message and channel configurations within the application, without use of MAX or a CAN database.

`nctCreateMessage` returns a task reference you wire to `nctStart` to start communication for the message and its channels.

## nctCreateMessageEx

---

### Purpose

Create a mode dependent message configuration and associated channel configurations within the application.

### Format

```

nctTypeStat  nctCreateMessageEx (
us
                u32                ConfigID,
                void                *MessageConfig,
                u32                NumberOfChannels,
                void                *ChannelConfigList,
                i32                Interface,
                i32                Mode,
                f64                SampleRate,
                nctTypeTaskRef     *TaskRef)

```

### Inputs

ConfigID

Specifies the type of structures you provide in `MessageConfig` and `ChannelConfigList`. The properties are similar to the message properties in MAX. Currently, the following values are supported.

1

In this case, the `MessageConfig` and `ChannelConfigList` parameters behave exactly as those described for the [nctCreateMessage](#) function. This mode is provided for compatibility.

2

This value allows you to define mode dependent channels. The `MessageConfig` parameter behaves the same way as for `ConfigId = 1`. The `ChannelConfigList` parameter must be passed an array of structures described below. For more

information, refer to the *Mode Dependent Channels* section of Chapter 6, *Using the Channel API*.

3

This value is reserved for internal purposes. Do not use.

All other values for this parameter return an error.

#### MessageConfig

Configures properties for a new message. For both `ConfigId = 1` and `ConfigId = 2`, you provide the properties as a pointer to a C struct.

The properties are similar to the message properties in MAX:

`u32 MsgArbitrationID`

Configures the arbitration ID of the message.

Use the `Extended` property to specify whether the ID is standard (11-bit) or extended (29-bit).

`u32 Extended`

Configures a Boolean value that indicates whether the message arbitration ID is standard 11-bit format (0) or extended 29-bit format (1).

`u32 MsgDataBytes`

Configures the number of data bytes in the message. The range is 0 to 8.

#### NumberOfChannels

Specifies the number of channel configurations you provide in `ChannelConfigList`.

#### ChannelConfigList

Configures the list of channels for the new message.

`ChannelConfigList` is an array of a C struct, with one C struct for each channel. The properties of each channel are similar to the channel properties in MAX. For `ConfigId = 1`, refer to the `ChannelConfigList` parameter of the `nctCreateMessage` function. For `ConfigId = 2` use this structure:

`u32 StartBit`

Configures the starting bit position in the message. The range is 0 (lowest bit in first byte), to 63 (highest bit in last byte).

`u32 NumBits`

Configures the number of bits in the message. The range is 1 to 64.



u32 `DataType`

Configures the data type of the channel in the message. Values are `nctDataSigned`, `nctDataUnsigned`, and `nctDataFloat`.

u32 `ByteOrder`

Configures the byte order of the channel in the message. Values are `nctOrderIntel` (little-endian), and `nctOrderMotorola` (big-endian).

f64 `ScalingFactor`

Configures the scaling factor used to convert raw bits of the message to/from scaled floating-point units. The scaling factor is the  $A$  in the linear scaling formula  $AX+B$ , where  $X$  is the raw data, and  $B$  is the scaling offset.

f64 `ScalingOffset`

Configures the scaling offset used to convert raw bits of the message to/from scaled floating-point units. The scaling offset is the  $B$  in the linear scaling formula  $AX+B$ , where  $X$  is the raw data, and  $A$  is the scaling factor.

f64 `MaxValue`

Configures the maximum value of the channel in scaled floating-point units.

The `nctRead` and `nctWrite` functions do not coerce samples when converting to/from CAN messages. You can use this value with the user-interface functions of the development environment to set the range of front-panel controls and indicators.

f64 `MinValue`

Configures the minimum value of the channel in scaled floating-point units.

The `nctRead` and `nctWrite` functions do not coerce samples when converting to/from CAN messages. You can use this value with the user-interface functions of the development environment to set the range of front-panel controls and indicators.

f64 `DefaultValue`

Configures the default value of the channel in scaled floating-point units.

For information on how the `DefaultValue` is used, refer to the `nctRead` and `nctWrite` functions.

`const str Unit`

Configures the unit string of the channel. The string is no more than 64 characters in length.

You can use this value to display units (such as volts or RPM) along with the samples of the channel.

`u32 NumModeChannels`

Configures whether to use a mode channel for this channel. The range is 0 to 1. For 0, this channel is valid in each frame (mode independent channel). For 1, this channel is valid only if the mode channel described in the `ModeChannel` struct applies (mode dependent channel). For more information, refer to the *Mode Dependent Channels* section of Chapter 6, *Using the Channel API*.

`struct ModeChannel`

Configures the mode channel for this (data) channel. Note that the same mode channel can be specified for several channels. The structure contains following fields:

Interface

Specifies the CAN interface to use for this task.

The `interface` input uses an enumeration in which value 0 selects CAN0, value 1 selects CAN1, and so on.

The special interface values 256 and 257 refer to virtual interfaces. For more information on usage of virtual interfaces, refer to the *Frame to Channel Conversion* section of Chapter 6, *Using the Channel API*.

Mode

Specifies the I/O mode for the task. For an overview of the I/O modes, including figures, refer to the *Channel API Basic Programming Model* section of Chapter 6, *Using the Channel API*.

`nctModeInput`

Input channel data from received CAN messages. Use the `nctRead` function to obtain input samples as single-point, array, or waveform. Each sample value that you write is transmitted in a message on the network. If you write an array or waveform, the samples are buffered for subsequent transmit.

Use this input mode to read waveforms of timed samples, such as for comparison with NI-DAQ or NI-DAQmx waveforms. You also can use this input mode to read a single point from the most recent message, such as for control or simulation.

For this mode, the channels in `ChannelList` can be contained in multiple messages.

#### `nctModeOutput`

Output channel data to CAN messages for transmit. Use the `nctWrite` function to write output samples as single-point, array, or waveform.

For this mode, there are restrictions on using channels in `ChannelList` that are contained in multiple messages. Refer to the `nctWrite` function for more information.

#### `nctModeOutputRecent`

Output channel data to CAN messages for transmit. This mode is used with sample rate greater than zero (periodic transmit). Use `nctWrite` to provide a single sample per channel. Each periodic message uses the sample values from the most recent `nctWrite`.

For this mode, there are restrictions on using channels in channel list that are contained in multiple messages. Refer to the `nctWrite` function for more information.

#### `nctModeTimestampedInput`

Input channel data from received CAN messages. Use the `nctReadTimestamped` function to obtain input samples as an array of sample/timestamp pairs (refer to the `nctReadTimestamped` function for more information).

For this mode, the channels in `ChannelList` must be contained in a single message.

Use this input mode to read samples with timestamps that indicate when each message is received from the network.

#### `SampleRate`

Specifies the timing to use for samples of the task. The sample rate is specified in Hertz (samples per second). A sample rate of zero means to sample immediately.

For Mode of `NctModeInput`, `SampleRate` of zero means `nctRead` returns a single point from the most recent message received, and greater than zero means `nctRead` returns samples timed at the specified rate.

For Mode of `nctModeOutput`, `SampleRate` of zero means CAN messages transmit immediately when `nctWrite` is called, and greater than zero means CAN messages are transmitted periodically at the specified rate.

For Mode of `NctModeTimestampedInput`, `SampleRate` is ignored.

When the `Interface` specifies a virtual interface (256 or 257), and `Mode` is `nctModeOutput` or `nctModeOutputRecent`, this `SampleRate` must be zero (greater than zero not supported).

## Outputs

`TaskRef`

Use `TaskRef` with all subsequent functions to reference the task. Pass this task reference to `nctStart` before you read or write samples for the message.

## Return Value

The return value indicates the status of the function call as a signed 32-bit integer. Zero means the function executed successfully. A negative value specifies an error, which means the function did not perform the expected behavior. A positive value specifies a warning, which means the function performed as expected, but a condition arose that may require attention.

Use the `ncStatusToString` function of the Frame API to obtain a descriptive string for the return value. The `ncStatusToString` and `ncGetHardwareInfo` functions are the only Frame API functions that can be called within a Channel API application.

## Description

To use message and channel configurations from MAX or a CAN database, use the `nctInitStart` or `nctInitialize` functions. The `nctCreateMessage` function provides an alternative in which you create the message and channel configurations within the application, without use of MAX or a CAN database.

`nctCreateMessage` returns a task reference you wire to `nctStart` to start communication for the message and its channels.

## nctDisconnectTerminals

---

### Purpose

Disconnect terminals in the CAN hardware.

### Format

```
nctTypeStatus  nctDisconnectTerminals (
                nctTypeTaskRef          TaskRef,
                u32                      SourceTerminal,
                u32                      DestinationTerminal,
                u32                      Modifiers);
```

### Inputs

#### TaskRef

Task reference from the previous NI-CAN function. The task reference is originally returned from [nctInitStart](#), [nctInitialize](#), or [nctCreateMessage](#).

#### SourceTerminal

Specifies the source of the connection.

For a description of values for `SourceTerminal`, refer to [nctConnectTerminals](#).

#### DestinationTerminal

Specifies the destination of the connection.

For a description of values for `DestinationTerminal`, refer to [nctConnectTerminals](#).

#### Modifiers

Provides optional connection information for certain source/destination pairs. The current release of NI-CAN does not use this information for any source/destination pair, so you must pass `Modifiers` as zero.

## Outputs

### Return Value

The return value indicates the status of the function call as a signed 32-bit integer. Zero means the function executed successfully. A negative value specifies an error, which means the function did not perform the expected behavior. A positive value specifies a warning, which means the function performed as expected, but a condition arose that may require attention.

Use the `ncStatusToString` function of the Frame API to obtain a descriptive string for the return value. The `ncStatusToString` and `ncGetHardwareInfo` functions are the only Frame API functions that can be called within a Channel API application.

## Description

This function disconnects a specific pair of source/destination terminals you previously connected with `nctConnectTerminals`.

When the final task for a given interface is cleared with `nctClear`, NI-CAN disconnects all terminal connections for that interface. Therefore, the `nctDisconnectTerminals` function is not required for most applications. You typically use this function to change RTSI connections dynamically while the application is running. First use `nctStop` to stop all tasks for the interface, then use `nctDisconnectTerminals` and `nctConnectTerminals` to adjust RTSI connections, then `nctStart` to restart sampling.

## nctGetNames

---

### Purpose

Get an array of CAN channel names or message names from MAX or a CAN database file.

### Format

```
nctTypeStatus nctGetNames (
    cstr        FilePath,
    u32         Mode,
    cstr        MessageName,
    u32         SizeofChannelList,
    str         ChannelList);
```

### Inputs

#### FilePath

FilePath is an optional path to a CAN database file from which to get channel names. The file must use either .DBC or .NCD extension. Files with extension .DBC use the CANdb database format. Files with extension .NCD use the NI-CAN database format. You can generate NI-CAN database files from the **Save Channels** selection in MAX.

If you pass NULL or empty-string to FilePath, this function gets the channel names from MAX. The MAX CAN channels are in the MAX CAN channels listing within **Data Neighborhood**.

#### Mode

Specifies the type of names to return.

nctGetNamesModeChannels

Return list of channel names. You can pass the returned ChannelList to [nctInitStart](#).

nctGetNamesModeMessages

Return list of message names.

#### MessageName

MessageName is an optional input that filters the names for a specific message. If you pass NULL or empty-string to MessageName, this

function returns all names in the database. If you pass a non empty string, the `ChannelList` output is limited to channels of the specified message.

This input applies to `Mode` of `nctGetNamesModeChannels` only. It is ignored for `Mode` of `nctGetNamesModeMessages`.

`SizeofChannelList`

Number of bytes allocated for the `ChannelList` output.

If all of the channel names do not fit in the allocated `ChannelList`, this function returns as much as possible with an error.

Use the `nctGetNamesLength` function to determine the proper `SizeofChannelList`.

## Outputs

`ChannelList`

Returns the comma-separated list of channel names.

Each name in `ChannelList` uses the minimum syntax required to properly initialize:

- If a channel name is used within only one message in the database, `nctGetNames` returns only the channel name in the list. If a channel name is used within multiple messages, `nctGetNames` prepends the message name to that channel name, with a decimal point separating the message and channel name. This syntax ensures that the duplicate channel is associated to a single message in the database.

For more information on the syntax conventions for channel names, refer to the `nctInitStart` function.

To start a task for all channels returned from `nctGetNames`, pass `ChannelList` to the `nctInitStart` function to start a task.

You also can use `ChannelList` with a user-interface control such as a ring or list box. The user of the application can then select names using this control, and the selected names can be passed to `nctInitStart`.

## Return Value

The return value indicates the status of the function call as a signed 32-bit integer. Zero means the function executed successfully. A negative value specifies an error, which means the function did not perform the expected behavior. A positive value specifies a warning, which means the function performed as expected, but a condition arose that may require attention.



Use the `ncStatusToString` function of the Frame API to obtain a descriptive string for the return value. The `ncStatusToString` and `ncGetHardwareInfo` functions are the only Frame API functions that can be called within a Channel API application.



**Note** The function `nctGetNames` returns the string results as an array of `char (*char)`. VB is not able to convert this array to a string automatically. Therefore, VB users should call the wrapper function `nct_GetNames`.

## nctGetNamesLength

---

### Purpose

Get the required size for a specified list of channels to allocate an array for the `ChannelList` input of `nctGetNames`.

### Format

```
nctTypeStatus  nctGetNamesLength(
                cstr                FilePath,
                u32                 Mode,
                cstr                MessageName,
                u32                 *SizeofChannelList);
```

### Inputs

#### FilePath

`FilePath` is an optional path to a CAN database file from which to get channel names. The file must use either the `.DBC` or `.NCD` extension.

If you pass `NULL` or empty-string to `FilePath`, this function examines the channel names from `MAX`.

For more information on `FilePath`, refer to the `nctGetNames` function.

#### Mode

Specifies the type of names to examine.

`nctGetNamesModeChannels`

Examine the list of channel names.

`nctGetNamesModeMessages`

Examine the list of message names.

#### MessageName

`MessageName` is an optional input that filters the names for a specific message. If you pass `NULL` or empty-string to `MessageName`, this function returns all names in the database. If you pass a nonempty string, the `SizeofChannelList` output is limited to channels of the specified message.

This input applies to Mode of `nctGetNamesModeChannels` only. It is ignored for Mode of `nctGetNamesModeMessages`.

## Outputs

`SizeofChannelList`

Number of bytes required for `nctGetNames` to return all names for the specified `FilePath`, `Mode`, and `MessageName`. After calling `nctGetNamesLength`, you can allocate an array of size `SizeofChannelList`, then pass that array to `nctGetNames` using the same input parameters. This ensures that `nctGetNames` will return all names without error.

## Return Value

The return value indicates the status of the function call as a signed 32-bit integer. Zero means the function executed successfully. A negative value specifies an error, which means the function did not perform the expected behavior. A positive value specifies a warning, which means the function performed as expected, but a condition arose that may require attention.

Use the `ncStatusToString` function of the Frame API to obtain a descriptive string for the return value. The `ncStatusToString` and `ncGetHardwareInfo` functions are the only Frame API functions that can be called within a Channel API application.

## nctGetProperty

---

### Purpose

Get a property for the task, or a single channel within the task.

### Format

```
nctTypeStatus nctGetProperty(
    nctTypeTaskRef TaskRef,
    cstr ChannelName,
    u32 PropertyId,
    u32 SizeofValue,
    void *Value);
```

### Inputs

#### TaskRef

Task reference from the previous NI-CAN function. The task reference is originally returned from [nctInitStart](#), [nctInitialize](#), or [nctCreateMessage](#).

#### ChannelName

Specifies an individual channel within the task. If you pass empty-string to ChannelName, this means the property applies to the entire task, not a specific channel.

Properties that begin with the word *Channel* or *Message* do not apply to the entire task, but an individual channel or message within the task. For these channel-specific properties, you must pass the name of a channel from a channel list into the ChannelName input.

For properties that do not begin with the word *Channel* or *Message*, you must pass empty-string (" ") into ChannelName. You must not pass NULL into ChannelName.

#### PropertyId

Selects the property to get.

For a description of each property, including its data type and PropertyId, refer to the [Properties](#) section of this function reference.

**SizeofValue**

Number of bytes allocated for the `Value` output. This size normally depends on the data type listed in the description of the property.

**Outputs****Value**

Returns the property value. `PropertyId` determines the data type of the returned value.

**Return Value**

The return value indicates the status of the function call as a signed 32-bit integer. Zero means the function executed successfully. A negative value specifies an error, which means the function did not perform the expected behavior. A positive value specifies a warning, which means the function performed as expected, but a condition arose that may require attention.

Use the `ncStatusToString` function of the Frame API to obtain a descriptive string for the return value. The `ncStatusToString` and `ncGetHardwareInfo` functions are the only Frame API functions that can be called within a Channel API application.

**Properties****u32 nctPropBehavAfterFinalOut**

Returns the `nctPropBehavAfterFinalOut` property, which is used with some output task configurations. For more information, refer to the `nctPropBehavAfterFinalOut` property in [nctSetProperty](#).

**u32 nctPropChanByteOrder**

Returns the byte order of the channel in the message. Values are `nctOrderIntel` (little-endian), and `nctOrderMotorola` (big-endian).

The value of this property is originally set within MAX or the CAN database and cannot be changed using [nctSetProperty](#).

**u32 nctPropChanDataType**

Returns the data type of the channel in the message. Values are `nctDataSigned`, `nctDataUnsigned`, and `nctDataFloat`.

The value of this property is originally set within MAX or the CAN database and cannot be changed using [nctSetProperty](#).

f64 `nctPropChanDefaultValue`

Returns the default value of the channel in scaled floating-point units. For information on how `nctPropChanDefaultValue` is used, refer to the `nctRead` and `nctWrite` functions.

The value of this property is originally set within MAX. If the channel is initialized directly from a CAN database, the value is 0.0 by default, but it can be changed using `nctSetProperty`.

u32 `nctPropChanIsModeDependent`

Returns if a channel is mode dependent (1) or not (0).

f64 `nctPropChanMaxValue`

Returns the maximum value of the channel in scaled floating-point units.

The `nctRead` and `nctWrite` functions do not coerce samples when converting to/from CAN messages. You can use this value with the user-interface functions of the development environment to set the range of front-panel controls and indicators.

The value of this property is originally set within MAX or the CAN database and cannot be changed using `nctSetProperty`.

f64 `nctPropChanMinValue`

Returns the minimum value of the channel in scaled floating-point units.

The `nctRead` and `nctWrite` functions do not coerce samples when converting to/from CAN messages. You can use this value with the user-interface functions of the development environment to set the range of front-panel controls and indicators.

The value of this property is originally set within MAX or the CAN database and cannot be changed using `nctSetProperty`.

u32 `nctPropChanModeValue`

Returns the value of the mode channel associated to this channel. This property applies only to mode dependent channels. For more information, refer to the *Mode Dependent Channels* section of Chapter 6, *Using the Channel API*.

u32 `nctPropChanNumBits`

Returns the number of bits in the channel. The range is 0 to 64.

The value of this property is originally set within MAX or the CAN database and cannot be changed using `nctSetProperty`.

f64 nctPropChanScalFactor

Returns the scaling factor used to convert raw bits of the message to/from scaled floating-point units. The scaling factor is the  $A$  in the linear scaling formula  $AX+B$ , where  $X$  is the raw data, and  $B$  is the scaling offset.

CAN messages use the raw data, and the `nctRead` and `nctWrite` functions provide access to samples in floating-point units.

The value of this property is originally set within MAX or the CAN database and cannot be changed using `nctSetProperty`.

f64 nctPropChanScalOffset

Returns the scaling offset used to convert raw bits of the message to/from scaled floating-point units. The scaling offset is the  $B$  in the linear scaling formula  $AX+B$ , where  $X$  is the raw data, and  $A$  is the scaling factor.

CAN messages use the raw data, and the `nctRead` and `nctWrite` functions provide access to samples in floating-point units.

The value of this property is originally set within MAX or the CAN database and cannot be changed using `nctSetProperty`.

u32 nctPropChanStartBit

Returns the starting bit position in the message. The range is 0 (lowest bit in first byte), to 63 (highest bit in last byte).

The value of this property is originally set within MAX or the CAN database and cannot be changed using `nctSetProperty`.

str nctPropChanUnitString

Returns the unit string of the channel. The string is no more than 80 characters in length.

You can use this value to display units (such as volts or RPM) along with the samples of the channel.

The value of this property is originally set within MAX or the CAN database and cannot be changed using `nctSetProperty`.

u32 nctPropHwFormFactor

Returns the hardware form factor for the NI-CAN hardware that contains **interface**. Values are `nctHwFormFactorPCI`, `nctHwFormFactorPXI`, `nctHwFormFactorPCMCIA`, and `nctHwFormFactorAT`.

u32 nctPropHwMasterTimebaseRate

Returns the present Hardware **Master Timebase Rate** in MHz, programmed into the CAN hardware. For PCMCIA, this property will always return 10 MHz.

u32 nctPropHwSerialNum

Returns the hardware serial number for the NI-CAN hardware that contains Interface.

u32 nctPropHwSeries

Returns the hardware series for the NI CAN hardware that contains Interface. Values are `nctHwSeries1`, `nctHwSeries2`, and `nctHwSeriesNIXNET`.

Newer hardware series are often capable of more features, so the application may need to determine which is installed.

u32 nctPropHwTimestampFormat

Returns the present Timestamp Format programmed into the CAN hardware. This property applies to the entire card.

u32 nctPropInterface

Returns the Interface initialized for the task, such as with the `nctInitStart` function.

u32 nctPropIntfBaudRate

Returns the baud rate in use by the Interface.

Basic baud rates such as 125000 and 500000 are specified as the numeric rate.

Advanced baud rates are specified as 8000XXYY hex, where YY is the value of Bit Timing Register 0 (BTR0), and XX is the value of Bit Timing Register 1 (BTR1). For more information, refer to the **Port Properties** dialog in MAX.

The value of this property is originally set within MAX, but it can be changed using `nctSetProperty`.

u32 nctPropIntfListenOnly

Returns a Boolean value that indicates whether the listen only feature of the Philips SJA1000 CAN controller is enabled (true) or disabled (false). For more information, refer to the `nctPropIntfListenOnly` property in `nctSetProperty`.



Since the listen only feature requires the Philips SJA1000 CAN controller, this property is supported on Series 2 NI CAN hardware only.

u32 nctPropIntfRxErrorCounter

Returns the Receive Error Counter as described in the CAN specification.

Since the error count requires the Philips SJA1000 CAN controller, this property is supported on Series 2 NI CAN hardware only. If you are using Series 1 NI CAN hardware, this property returns an error.

u32 nctPropIntfSelfReception

Returns the `nctPropIntfSelfReception` property as configured with `nct SetProperty`. This property is supported on Series 2 NI CAN hardware only (returns error for Series 1).

u32 nctPropIntfSeries2ErrArbCapture

Returns the current values of the Error Code Capture register and Arbitration Lost Capture register from the Philips SJA1000 CAN controller chip.

The Error Code Capture register provides information on bus errors that occur according to the CAN standard. A bus error increments either the Transmit Error Counter or the Receive Error Counter. When communication starts on the interface, the first bus error is captured into the Error Code Capture register, and retained until you get this property. After you get this property, the Error Code Capture register is again enabled to capture information for the next bus error.

The Arbitration Lost Capture register provides information on a loss of arbitration during transmits. Loss of arbitration is not considered an error. When communication starts on the interface, the first arbitration loss is captured into the Arbitration Lost Capture register, and retained until you get this property. After you get this property, the Arbitration Lost Capture register is again enabled to capture information for the next arbitration loss.

For each of the capture registers, a single-bit New flag indicates whether a new error has occurred since the last Get. If the New flag of a register is set, the associated fields contain new information. If the New flag of a register is clear, the associated fields are the same as the previous Get.

This property is commonly used with the `nctPropIntfSingleShotTx` property. When `nctWrite` is used to transmit the single frame, you can get this property to determine if the

transmit was successful. If the single shot transmit was not successful, this property provides detailed information for the failure.

This property is supported for Series 2 hardware only (Series 1 returns error). Since the information and bit format is very specific to the Philips SJA1000 CAN controller on Series 2 hardware, National Instruments cannot guarantee compatibility for this property on future hardware series. When using this property in the application, it is best to get the `nctPropHwSeries` property to verify that the CAN hardware is Series 2.

For information regarding the format of the bits in this property, refer to the `NC_ATTR_SERIES2_ERR_ARB_CAPTURE` attribute in the `ncGetAttribute` function of the Frame API.

u32 `nctPropIntfSeries2Comp`

Returns the value of the `nctPropIntfSeries2Comp` property (refer to `nctSetProperty`).

u32 `nctPropIntfSeries2FilterMode`

Returns the value of the `nctPropIntfSeries2FilterMode` property (refer to `nctSetProperty`).

u32 `nctPropIntfSeries2Mask`

Returns the value of the `nctPropIntfSeries2Mask` property (refer to `nctSetProperty.html`).

u32 `nctPropIntfSingleShotTx`

Returns the value of the `nctPropIntfSingleShotTx` property (refer to `nctSetProperty`).

u32 `nctPropIntfTransceiverExternalIn`

Returns the transceiver external inputs for the interface that was initialized for the task.

Series 2 XS cards enable connection of an external transceiver. For an external transceiver, this property allows you to determine the input voltage on the STATUS pin of the CAN port.

For many models of CAN transceiver, an NERR pin is provided for detection of faults and other status. For such transceivers, you can wire the NERR pin to the STATUS pin of the CAN port.

This property is supported for Series 2 XS cards only.

This property uses a bit mask. When using the property, use bitwise AND operations to check for values, not equality checks (equal, greater than, and so on).

`nctTransceiverInStatus` (00000001 hex, STATUS pin)

This bit is set when 5 V exists on the STATUS pin.

This bit is clear when 0 V exists on the STATUS pin.

u32 `nctPropIntfTransceiverExternalOut`

Returns the transceiver external outputs for the interface that was initialized for the task.

Series 2 XS cards enable connection of an external transceiver. For an external transceiver, this property allows you to determine the output voltage on the MODE0 and MODE1 pins of the CAN port, and it allows you to determine if the CAN controller chip is sleeping.

For more information on the format of the value returned in this property, refer to the description of `nctPropIntfTransceiverExternalOut` in [nct SetProperty](#).

This property is supported for Series 2 XS cards only.

u32 `nctPropIntfTransceiverMode`

Returns the transceiver mode for the interface that was initialized for the task. The transceiver mode changes when you set the mode within the application, or when a remote wakeup transitions the interface from Sleep to Normal mode. For more information, refer to [nct SetProperty](#).

This property is supported for Series 2 cards only.

This property uses the following values:

`nctTransceiverModeNormal`

Transceiver is awake in Normal communication mode.

`nctTransceiverModeSleep`

Transceiver and the CAN controller chip are both in Sleep mode.

`nctTransceiverModeSWWakeup`

Single Wire transceiver is in Wakeup Transmission mode.

`nctTransceiverModeSWHighSpeed`

Single Wire transceiver is in High-Speed Transmission mode.

u32 `nctPropIntfTransceiverType`

Returns the type of transceiver for the interface that was initialized for the task. For hardware other than Series 2 XS cards, the transceiver type is fixed. For Series 2 XS cards, the transceiver type reflects the most recent value specified by MAX or [nct SetProperty](#).

This property is not supported on the PCMCIA form factor.

This property uses the following values:

`nctTransceiverTypeHS`

Transceiver type is High-Speed (HS).

`nctTransceiverTypeLS`

Transceiver type is Low-Speed/Fault-Tolerant (LS).

`nctTransceiverTypeSW`

Transceiver type is Single Wire (SW).

`nctTransceiverTypeExternal`

Transceiver type is External. This transceiver type is available on Series 2 XS cards only. For more information, refer to [nct SetProperty](#).

`nctTransceiverTypeDisconnect`

Transceiver type is Disconnect. This transceiver type is available on Series 2 XS cards only. For more information, refer to [nct SetProperty](#).

u32 `nctPropIntfTxErrorCounter`

Returns the Transmit Error Counter as described in the CAN specification.

Since the error count requires the Philips SJA1000 CAN controller, this property is supported on Series 2 NI CAN hardware only. If you are using Series 1 NI CAN hardware, this property returns an error.

u32 `nctPropIntfVirtualBusTiming`

Returns a Boolean value of True or False to indicate whether Virtual Bus Timing has been set or not for the specified virtual task. This property is applicable to all tasks opened on the virtual interface.

If this property is selected on real hardware, an error will be returned.

u32 `nctPropMode`

Returns the mode initialized for the task, such as with the [nctInitStart](#) function.

u32 `nctPropMsgArbitrationId`

Returns the arbitration ID of the channel message.

To determine whether the ID is standard (11-bit) or extended (29-bit), get the `nctPropMsgIsExtended` property.

The value of this property is originally set within MAX or the CAN database and cannot be changed using [nct SetProperty](#).

u32 nctPropMsgByteLength

Returns the number of data bytes in the channel message. The range is 0 to 8.

The value of this property is originally set within MAX or the CAN database and cannot be changed using [nct SetProperty](#).

u32 nctPropMsgIsExtended

Returns a Boolean value that indicates whether the arbitrationID of the channel message is standard 11-bit format (0) or extended 29-bit format (1).

The value of this property is originally set within MAX or the CAN database and cannot be changed using [nct SetProperty](#).

str nctPropMsgName

Returns the name of the channel message. The string is no more than 80 characters in length.

The value of this property is originally set within MAX or the CAN database and cannot be changed using [nct SetProperty](#).

u32 nctPropMsgDistribution

Returns the `nctPropMsgDistribution` which is used to determine if the CAN frames associated to a group of mode dependent channels are sent even spaced or in burst mode. This property applies only for mode dependent channels that are transmitted periodically. For more information, refer to the *Mode Dependent Channels* section of Chapter 6, *Using the Channel API*.

f64 nctPropNoValue

Returns the value that is returned on timestamped read for mode dependent channels that have not been received with the most recent CAN frame associated with the CAN message. This Property applies only to mode dependent channels that are read with the timestamped read operation. For more information, refer to the *Mode Dependent Channels* section of Chapter 6, *Using the Channel API*.

u32 nctPropNumChannels

Returns the number of channels initialized in **channel list**. This is the number of array entries required when using [nctRead](#) or [nctWrite](#).

f64 nctPropSampleRate

Returns the sample rate initialized for the task, such as with the [nctInitStart](#) function.

u32 nctPropSamplesPending

Returns the number of samples available to be read using `nctRead`. If you set the `NumberOfSamplesToRead` input of `nctRead` to this value, `nctRead` returns immediately without waiting.

This property applies only to tasks initialized with `Mode` of `NctModeInput`, and `SampleRate` greater than zero. For all other configurations, it returns an error.

f64 nctPropTimeout

Returns the `nctPropTimeout` property, which is used with some task configurations. For more information, refer to the `nctPropTimeout` property in `nctSetProperty`.

u32 nctPropVersionBuild

Returns the build number of the NI-CAN software. This number applies to `nctPhaseDevelopment`, `nctPhaseAlpha`, and `nctPhaseBeta` phase only, and should be ignored for `nctPhaseRelease` phase.

str nctPropVersionComment

Returns a comment string for the NI-CAN software. If you received a custom release of NI-CAN from National Instruments, this comment often describes special features of the release.

u32 nctPropVersionMajor

Returns the major version of the NI-CAN software, such as the `2` in version `2.1.5`.

u32 nctPropVersionMinor

Returns the minor version of the NI-CAN software, such as the `1` in version `2.1.5`.

u32 nctPropVersionPhase

Returns the phase of the NI-CAN software. Values are `nctPhaseDevelopment`, `nctPhaseAlpha`, `nctPhaseBeta`, and `nctPhaseRelease`. Versions of NI-CAN in hardware kits or on `ni.com` will always be `nctPhaseRelease`.

u32 nctPropVersionUpdate

Returns the update version of the NI-CAN software, such as the `5` in version `2.1.5`.

## nctInitialize

---

### Purpose

Initialize a task for the specified channel list.

### Format

```
nctTypeStatus  nctInitialize(
                cstr           ChannelList,
                i32            Interface,
                i32            Mode,
                f64            SampleRate,
                nctTypeTaskRef *TaskRef);
```

### Inputs

ChannelList

Comma-separated list of channel names to initialize as a task.

For more information, refer to the channel list input of [nctInitStart](#).

Interface

Specifies the CAN interface to use for this task.

The `interface` input uses an enumeration in which value 0 selects CAN0, value 1 selects CAN1, and so on.

If you pass the special value -1 to `Interface`, this function uses the default interface as defined in the Message/Channel configuration properties. If the default interface in MAX is **All**, or if one or more channels in `ChannelList` specifies a *filepath*, the `Interface` is a required input to this function.

The Channel API and Frame API cannot use the same CAN network interface simultaneously. If the CAN network interface is already initialized in the Frame API, this function returns an error.

The special interface values 256 and 257 refer to virtual interfaces. For more information on usage of virtual interfaces, refer to the [Frame to Channel Conversion](#) section of Chapter 6, [Using the Channel API](#).

## Mode

Specifies the I/O mode for the task. For an overview of the I/O modes, including figures, refer to the *Channel API Basic Programming Model* section of Chapter 6, *Using the Channel API*.

`nctModeInput`

Input channel data from received CAN messages. Use the `nctRead` function to obtain input samples as single-point, array, or waveform. Each sample value that you write is transmitted in a message on the network. If you write an array or waveform, the samples are buffered for subsequent transmit.

Use this input mode to read waveforms of timed samples, such as for comparison with NI-DAQ or NI-DAQmx waveforms. You also can use this input mode to read a single point from the most recent message, such as for control or simulation.

For this mode, the channels in `ChannelList` can be contained in multiple messages.

`nctModeOutput`

Output channel data to CAN messages for transmit. Use the `nctWrite` function to write output samples as single-point, array, or waveform.

For this mode, there are restrictions on using channels in `ChannelList` that are contained in multiple messages. Refer to `nctWrite` for more information.

`nctModeOutputRecent`

Output channel data to CAN messages for transmit. This mode is used with sample rate greater than zero (periodic transmit). Use `nctWrite` to provide a single sample per channel. Each periodic message uses the sample values from the most recent `nctWrite`.

For this mode, there are restrictions on using channels in channel list that are contained in multiple messages. Refer to `nctWrite` for more information.

`nctModeTimestampedInput`

Input channel data from received CAN messages. Use the `nctRead` function to obtain input samples as an array of sample/timestamp pairs (refer to `nctReadTimestamped`).

Use this input mode to read samples with timestamps that indicate when each message is received from the network.

For this mode, the channels in `ChannelList` must be contained in a single message.



**SampleRate**

Specifies the timing to use for samples of the task. The sample rate is specified in Hertz (samples per second). A sample rate of zero means to sample immediately.

For Mode of `NctModeInput`, `SampleRate` of zero means `nctRead` returns a single point from the most recent message received, and greater than zero means `nctRead` returns samples timed at the specified rate.

For Mode of `NctModeOutput`, `SampleRate` of zero means CAN messages transmit immediately when `nctWrite` is called, and greater than zero means CAN messages are transmitted periodically at the specified rate.

For Mode of `NctModeTimestampedInput`, `SampleRate` is ignored.

When the Interface specifies a virtual interface (256 or 257), and Mode is `nctModeOutput` or `nctModeOutputRecent`, this `SampleRate` must be zero (greater than zero not supported).

## Outputs

**TaskRef**

Use `TaskRef` with all subsequent functions to reference the task. Pass this task reference to `nctStart` before you read or write samples for the message.

## Return Value

The return value indicates the status of the function call as a signed 32-bit integer. Zero means the function executed successfully. A negative value specifies an error, which means the function did not perform the expected behavior. A positive value specifies a warning, which means the function performed as expected, but a condition arose that may require attention.

Use the `ncStatusToString` function of the Frame API to obtain a descriptive string for the return value. The `ncStatusToString` and `ncGetHardwareInfo` functions are the only Frame API functions that can be called within a Channel API application.

## Description

The `nctInitialize` function does not start communication. This enables you to use `nctSetProperty` to change the properties of the task, or `nctConnectTerminals` to synchronize CAN or DAQ cards. After you change properties or connections, use `nctStart` to start communication for the task.

## nctInitStart

---

### Purpose

Initialize a task for the specified channel list, then start communication.

### Format

```
nctTypeStatus    nctInitStart (
                  cstr          ChannelList,
                  i32           Interface,
                  i32           Mode,
                  f64           SampleRate,
                  nctTypeTaskRef *TaskRef);
```

### Inputs

ChannelList

Comma-separated list of channel names to initialize as a task.

You can type in the channel list as a string constant, or you can obtain the list from MAX or another CAN database by using the [nctGetNames](#) function. Channel names are case sensitive.

You can initialize the same ChannelList with different Interface, Mode, or SampleRate, because each task reference is unique.

If you are using mode dependent channels, and each channel name is not unique, you will need to use a special syntax described in the [Mode Dependent Channel Syntax](#) section at the end of the function description.

The following paragraphs describe the syntax of each channel name. Brackets indicate optional fields.

*[filepath::][message.]channel*

- *filepath* is the path to a CAN database file from which to import the channel (signal) configurations. The *filepath* must use Windows directory syntax, and must be followed by a double-colon.

If *filepath* is not included, the channel configuration is obtained from MAX. The MAX CAN channels are in the MAX CAN Channels listing within **Data Neighborhood**.

Once you specify a *filepath*, it will continue to be applied to subsequent names in the channel list until you specify a new *filepath*. After using *filepath* for a CAN database file, you can revert to using MAX by specifying an empty *filepath* (double colon only).

If you are using mode dependent channels, and each channel name is not unique, you will need to use a special syntax described in the [Mode Dependent Channel Syntax](#) section at the end of the function description.

- *message* refers to the message in which the *channel* is contained. The message name must be followed by a decimal point.

If the *channel* name occurs in multiple messages, you must specify the *message* name to identify the channel uniquely. Within MAX, channels with the same name in multiple messages are shown with a yellow exclamation point.

If the *channel* name is unique across all channels, the *message* name is not required.

- *channel* refers to the channel (signal) name in MAX or the *filepath* CAN database.

The following examples demonstrate the channel list syntax:

- List of channels from MAX, each channel name unique across all messages.  
myChan1,myChan2,myChan3
- List of channels from a CANdb file, each channel name unique across all messages.  
C:\MyCandb\MyChannels.DBC::myChan1  
myChan2,myChan3
- List of channels from MAX, with one channel duplicated across two messages. MyChan2 and MyChan3 must be unique across all messages.  
myMessage1.myChan1,myChan2,  
myMessage2.myChan1,myChan3
- List of two channels from a CANdb file, then two channels from MAX.  
C:\MyCandb\MoreChannels.DBC::myChan1,  
myChan2,::myChan3,myChan4

## Interface

Specifies the CAN interface to use for this task.

The interface input uses an enumeration in which value 0 selects CAN0, value 1 selects CAN1, and so on.

If you pass the special value -1 to `Interface`, this function uses the default interface as defined in the Message/Channel configuration properties. If the default interface in MAX is **All**, or if one or more channels in `ChannelList` specifies a *filepath*, the `Interface` is a required input to this function.

The Channel API and Frame API cannot use the same CAN network interface simultaneously. If the CAN network interface is already initialized in the Frame API, this function returns an error.

The special interface values 256 and 257 refer to virtual interfaces. For more information on usage of virtual interfaces, refer to the *Frame to Channel Conversion* section of Chapter 6, *Using the Channel API*.

## Mode

Specifies the I/O mode for the task. For an overview of the I/O modes, including figures, refer to the *Channel API Basic Programming Model* section of Chapter 6, *Using the Channel API*.

### nctModeInput

Input channel data from received CAN messages. Use the `nctRead` function to obtain input samples as single-point, array, or waveform. Each periodic message uses the sample values from the most recent `nctWrite`.

Use this input mode to read waveforms of timed samples, such as for comparison with NI-DAQ or NI-DAQmx waveforms. You also can use this input mode to read a single point from the most recent message, such as for control or simulation.

For this mode, the channels in `ChannelList` can be contained in multiple messages.

### nctModeOutput

Output channel data to CAN messages for transmit. Use the `nctWrite` function to write output samples as single-point, array, or waveform.

For this mode, there are restrictions on using channels in `ChannelList` that are contained in multiple messages. Refer to `nctWrite` for more information.

`nctModeOutputRecent`

Output channel data to CAN messages for transmit. This mode is used with sample rate greater than zero (periodic transmit). Use `nctWrite` to provide a single sample per channel. Each periodic message uses the sample values from the most recent `nctWrite`.

For this mode, there are restrictions on using channels in channel list that are contained in multiple messages. Refer to `nctWrite` for more information.

`nctModeTimestampedInput`

Input channel data from received CAN messages. Use the `nctRead` function to obtain input samples as an array of sample/timestamp pairs (refer to `nctReadTimestamped`).

For this mode, the channels in `ChannelList` must be contained in a single message.

Use this input mode to read samples with timestamps that indicate when each message is received from the network.

If `nctModeTimestampedInput` mode is used, the task cannot be started with `nctInitStart` because the `Value` for `invalid` data must be set up through `nctSetProperty` before calling `nctStart`. Use the sequence `nctInitialize`, `nctSetProperty` (`nctPropNoValue`), and `nctStart` instead.

`SampleRate`

Specifies the timing to use for samples of the task. The sample rate is specified in Hertz (samples per second). A sample rate of zero means to sample immediately.

For Mode of `NctModeInput`, `SampleRate` of zero means `nctRead` returns a single point from the most recent message received, and greater than zero means `nctRead` returns samples timed at the specified rate.

For Mode of `NctModeOutput`, `SampleRate` of zero means CAN messages transmit immediately when `nctWrite` is called, and greater than zero means CAN messages are transmitted periodically at the specified rate.

For Mode of `NctModeTimestampedInput`, `SampleRate` is ignored.

When the `Interface` specifies a virtual interface (256 or 257), and Mode is `nctModeOutput` or `nctModeOutputRecent`, this `SampleRate` must be zero (greater than zero not supported).

## Outputs

TaskRef

Use `TaskRef` with all subsequent functions to reference the running task. Because `nctInitStart` starts communication, you can pass this task reference to `nctRead` or `nctWrite`.

## Return Value

The return value indicates the status of the function call as a signed 32-bit integer. Zero means the function executed successfully. A negative value specifies an error, which means the function did not perform the expected behavior. A positive value specifies a warning, which means the function performed as expected, but a condition arose that may require attention.

Use the `ncStatusToString` function of the Frame API to obtain a descriptive string for the return value. The `ncStatusToString` and `ncGetHardwareInfo` functions are the only Frame API functions that can be called within a Channel API application.

## Description

The code for this function simply calls `nctInitialize` followed by `nctStart`. This provides an easy way to start a list of channels.

The following list describes the scenarios for which `nctInitStart` cannot be used:

- If you need to set properties for the channels, use `nctInitialize`, then `nctSetProperty`, then `nctStart`. The `nctInitStart` function starts communication, and most channel properties cannot be changed after the task is started.
- If you need to synchronize tasks for multiple NI-CAN, NI-DAQ, or NI-DAQmx cards, use `nctInitialize`, then `nctConnectTerminals` to synchronize, the `nctStart` to start communication.
- If you need to create channel configurations entirely within the application, without using MAX or a CAN database file, use `nctCreateMessage`, then `nctStart`. The `nctInitStart` function accepts only channel names defined in MAX or a CAN database file.

## Mode Dependent Channel Syntax

If you are using mode dependent channels, and each channel name is not unique, you will need to use a special syntax described in this section. For the large majority of channels, you can use the simple syntax described previously for channel list. The brackets [] define optional parameters:

*[message name.[[multiplexer.]mode\_value.]]channel.*

- *message* refers to the message in which the channel is contained. The *message name* must be followed by a decimal point. If the channel name is not unique within MAX or the database file, you must specify the *message name* to identify the channel uniquely.

Within MAX, channels with the same name are shown with a yellow exclamation point. This feature can be changed in the **CAN Channels»Options** dialog box.

If the channel name is unique across all channels, the *message name* is not required.

- *multiplexer* refers to the multiplexer name in MAX or the CAN database. The *message name* must be followed by a decimal point. It applies only to mode dependent messages and must be omitted for normal CAN channels. If more than one multiplexer is defined for the message and the channel name is not unique within the CAN message, you must specify the multiplexer name to identify the channel uniquely.
- *mode\_value* refers to the multiplexer mode in MAX or the CAN database. The *message name* must be followed by a decimal point. It applies only to mode dependent messages and must be omitted for normal CAN channels. If the channel name is not unique within the multiplexer, you must specify the mode to identify the channel uniquely.
- *channel* refers to the channel (signal) name in MAX or the CAN database.

You cannot use the same channel name for a normal CAN channel and a mode dependent CAN channel within the same CAN message.

If the name of a channel is unique within MAX or the database, it can be referenced by the channel API using its channel name.

For more information on mode dependent channels, refer to the *Mode Dependent Channels* section of Chapter 6, *Using the Channel API*.

## nctRead

---

### Purpose

Read samples from a CAN task initialized with `Mode` of `nctModeInput`. Samples are obtained from received CAN messages. For an overview of `nctRead`, refer to the [Read](#) section of Chapter 6, *Using the Channel API*.

### Format

```
nctTypeStatus  nctRead (
                nctTypeTaskRef      TaskRef,
                u32                   NumberOfSamplesToRead,
                nctTypeTimestamp     *StartTime,
                nctTypeTimestamp     *DeltaTime,
                f64                   *SampleArray,
                u32                   *NumberOfSamplesReturned);
```

### Inputs

#### TaskRef

Task reference from the previous NI-CAN function. The task reference is originally returned from `nctInitStart`, `nctInitialize`, or `nctCreateMessage`.

The `Mode` initialized for the task must be `NctModeInput`.

#### NumberOfSamplesToRead

Specifies the number of samples to read for the task. For single-sample input, pass 1 to this parameter.

If the initialized sample rate is zero, you must pass

`NumberOfSamplesToRead` no greater than 1. `SampleRate` of zero means `nctRead` immediately returns a single sample from the most recent message(s) received.



## Outputs

### StartTime

Returns the time of the first CAN sample in `SampleArray`.

This parameter is optional. If you pass `NULL` for the `StartTime` parameter, the `nctRead` function proceeds normally.

If the initialized `SampleRate` is greater than zero, the `StartTime` is determined by the sample timing.

If the initialized sample rate is zero, the `StartTime` is zero, because the most recent sample is returned regardless of timing.

`StartTime` uses the `nctTypeTimestamp` data type. The `nctTypeTimestamp` data type is a 64-bit unsigned integer compatible with the Microsoft Win32 `FILETIME` type. This absolute time is kept in a Coordinated Universal Time (UTC) format. UTC time is loosely defined as the current date and time of day in Greenwich, England. Microsoft defines its UTC time (`FILETIME`) as a 64-bit counter of 100 ns intervals that have elapsed since 12:00 a.m., January 1, 1601. Because `nctTypeTimestamp` is compatible with Win32 `FILETIME`, you can pass it into the Win32 `FileTimeToLocalFileTime` function to convert it to the local time zone, and then pass the resulting local time to the Win32 `FileTimeToSystemTime` function to convert to the Win32 `SYSTEMTIME` type. `SYSTEMTIME` is a struct with fields for year, month, day, and so on. For more information on Win32 time types and functions, refer to the Microsoft Win32 documentation.

### DeltaTime

Returns the time between each sample in `SampleArray`.

This parameter is optional. If you pass `NULL` for the `DeltaTime` parameter, the `nctRead` function proceeds normally.

If the initialized sample rate is greater than zero, the `DeltaTime` is determined by the sample timing.

If the initialized sample rate is zero, the `DeltaTime` is zero, because the most recent sample is returned regardless of timing.

`DeltaTime` uses the `nctTypeTimestamp` data type. The delta time is a relative 64-bit counter of 100 ns intervals, not an absolute UTC time. Nevertheless, you can use functions like the Win32 `FileTimeToSystemTime` function to convert to the Win32 `SYSTEMTIME` type. In addition, you can use the 32-bit `LowPart` of `DeltaTime` to obtain a simple 100 ns count, because `SampleRate s` as slow as 0.4 Hz are still limited to a 32-bit 100 ns count.

### SampleArray

Returns an array of arrays (2D array), one array for each channel initialized in the task. The array of each channel must have `NumberOfSamplesToRead` entries allocated.

For example, if you call `nctInitStart` with `ChannelList` of `mych1, mych2, mych3`, then call `nctRead` with `NumberOfSamplesToRead` of 10, `SampleArray` must be allocated as:

```
f64 SampleArray[3][10];
```

The order of channel entries in `SampleArray` is the same as the order in the original channel list.

If you need to determine the number of channels in the task after initialization, get the `nctPropNumChannels` property for the task reference.

If no message has been received since you started the task, the default value of the channel (`nctPropChanDefaultValue`) is returned in all entries of `SampleArray`.

### NumberOfSamplesReturned

Indicates the number of samples returned for each channel in `SampleArray`. The remaining entries are left unchanged (zero).

## Return Value

The return value indicates the status of the function call as a signed 32-bit integer. Zero means the function executed successfully. A negative value specifies an error, which means the function did not perform the expected behavior. A positive value specifies a warning, which means the function performed as expected, but a condition arose that may require attention.

Use the `ncStatusToString` function of the Frame API to obtain a descriptive string for the return value. The `ncStatusToString` and `ncGetHardwareInfo` functions are the only Frame API functions that can be called within a Channel API application.

## Description

When using `Mode` of `nctModeInput`, you can specify channels in `ChannelList` that span multiple messages.

If the initialized `SampleRate` is greater than zero, this function returns an array of samples, each of which indicates the value of the CAN channel at a specific point in time. The `nctRead` function waits for these samples to arrive in time before returning. In other words, the `SampleRate` specifies a virtual clock that copies the most recent value from CAN messages for each sample time. The changes in sample values from message to message

enable you to view the CAN channel over time, such as for comparison with other CAN or DAQ input channels. To avoid internal waiting, you can use `nctGetProperty` to obtain the `nctPropSamplesPending` property, and pass that as the `NumberOfSamplesToRead` parameter to `nctRead`.

If the initialized `SampleRate` is zero, `nctRead` immediately returns a single sample from the most recent message(s) received. For this single-point read, you must pass the `NumberOfSamplesToRead` parameter as 1.

You can use the return value of `nctRead` to determine whether a new message has been received since the previous call to `nctRead` (or `nctStart`). If no message has been received, the warning code `CanWarnOldData` is returned. If a new message has been received, the success code 0 is returned.

If no message has been received since you started the task, the default value of the channel (`nctPropChanDefaultValue`) is returned in all entries of `SampleArray`.

## nctReadTimestamped

---

### Purpose

Read samples from a CAN task initialized with Mode of `nctModeTimestampedInput`. For an overview of `nctReadTimestamped`, refer to the [Read Timestamped](#) section of Chapter 6, *Using the Channel API*.

### Format

```
nctTypeStatus nctReadTimestamped(
    nctTypeTaskRef TaskRef,
    u32 NumberOfSamplesToRead,
    nctTypeTimestamp *TimestampArray,
    f64 *SampleArray,
    u32 *NumberOfSamplesReturned);
```

### Inputs

TaskRef

Task reference from the previous NI-CAN function. The task reference is originally returned from `nctInitStart`, `nctInitialize`, or `nctCreateMessage`.

The Mode initialized for the task must be `NctModeTimestampedInput`.

NumberOfSamplesToRead

Specifies the number of samples to read for the task.

### Outputs

TimestampArray

Returns the time at which each corresponding sample in `SampleArray` was received in a CAN message.

The timestamps are returned as an array of arrays (2D array), one array for each channel initialized in the task. The array of each channel must have `NumberOfSamplesToRead` entries allocated.

For example, if you call `nctInitStart` with `ChannelList` of `mych1, mych2`, then call `nctReadTimestamped` with

NumberOfSamplesToRead of 20, both `TimestampArray` and `SampleArray` must be allocated as:

```
nctTypeTimestamp TimestampArray[2][20];
f64 SampleArray[2][20];
```

The order of channel entries in `TimestampArray` is the same as the order in the original channel list.

If you need to determine the number of channels in the task after initialization, get the `nctPropNumChannels` property for the task reference.

Each timestamp in `TimestampArray` uses the `nctTypeTimestamp` data type. The `nctTypeTimestamp` data type is a 64-bit unsigned integer compatible with the Microsoft Win32 `FILETIME` type. This absolute time is kept in a Coordinated Universal Time (UTC) format. UTC time is loosely defined as the current date and time of day in Greenwich, England. Microsoft defines its UTC time (`FILETIME`) as a 64-bit counter of 100 ns intervals that have elapsed since 12:00 a.m., January 1, 1601. Because `nctTypeTimestamp` is compatible with Win32 `FILETIME`, you can pass it into the Win32 `FileTimeToLocalFileTime` function to convert it to the local time zone, and then pass the resulting local time to the Win32 `FileTimeToSystemTime` function to convert to the Win32 `SYSTEMTIME` type. `SYSTEMTIME` is a struct with fields for year, month, day, and so on. For more information on Win32 time types and functions, refer to the Microsoft Win32 documentation.

#### `SampleArray`

Returns the sample value(s) for each received CAN message.

The samples are returned as an array of arrays (2D array), one array for each channel initialized in the task. The array of each channel must have `NumberOfSamplesToRead` entries allocated.

You must allocate `SampleArray` exactly as `TimestampArray`, and the order of channel entries is the same for both.

#### `NumberOfSamplesReturned`

Indicates the number of samples returned for each channel in `SampleArray`, and the number of timestamps returned for each channel in `TimestampArray`. The remaining entries are left unchanged (zero).

## Return Value

The return value indicates the function call status as a signed 32-bit integer. Zero means the function executed successfully. A negative value specifies an error, which means the function did not perform the expected behavior. A positive value specifies a warning, which means the function performed as expected, but a condition arose that may require attention.

Use the `ncStatusToString` function of the Frame API to obtain a descriptive string for the return value. The `ncStatusToString` and `ncGetHardwareInfo` functions are the only Frame API functions that can be called within a Channel API application.

## Description

Each returned sample corresponds to a received CAN message for the channels initialized in **channel list**. For each sample, `nctReadTimestamped` returns the sample value and a timestamp that indicates when the message was received.

When using Mode of `nctModeTimestampedInput`, you *cannot* specify channels in `ChannelList` that span multiple messages.

Because the timing of samples returned by `nctReadTimestamped` is determined by when the message is received, the initialized sample rate is not used.

The `nctPropTimeout` property determines whether this function waits for the `NumberOfSamplesToRead` messages to arrive from the network. The default value of `nctPropTimeout` is zero, but you can change it using the `nctSetProperty` function.

If `nctPropTimeout` is greater than zero, the function will wait for `NumberOfSamplesToRead` messages to arrive. If `NumberOfSamplesToRead` messages are not received before the `nctPropTimeout` expires, an error is returned.

If `nctPropTimeout` is zero, the function does not wait for messages, but instead returns samples from the messages received since the previous call to `nctReadTimestamped`. The number of samples returned is indicated in the `NumberOfSamplesReturned` output, up to a maximum of `NumberOfSamplesToRead` messages. If no new message has been received, `NumberOfSamplesReturned` is 0, and the return value indicates success.

## nctSetProperty

---

### Purpose

Set a property for the task, or a single channel within the task.

### Format

```
nctTypeStatus  nctSetProperty
                (
                nctTypeTaskRef  TaskRef,
                cstr             ChannelName,
                u32              PropertyId,
                u32              SizeofValue,
                void             *Value);
```

### Inputs

#### TaskRef

Task reference from the previous NI-CAN function. The task reference is originally returned from [nctInitStart](#), [nctInitialize](#), or [nctCreateMessage](#).

#### ChannelName

Specifies an individual channel within the task. If you pass NULL or empty-string to ChannelName, this means the property applies to the entire task, not a specific channel.

Properties that begin with the word *Channel* or *Message* do not apply to the entire task, but an individual channel or message within the task. For these channel-specific properties, you must pass the name of a channel from the channel list into the ChannelName input.

For properties that do not begin with the word *Channel* or *Message*, you must pass empty-string ( " ") into ChannelName. You must not pass NULL into ChannelName.

#### PropertyId

Selects the property to set.

For a description of each property, including its data type and PropertyId, refer to the [Properties](#) section in this function reference.

**SizeofValue**

Number of bytes provided for the `Value` output. This size will normally depend on the data type listed in the description of the property.

**Value**

Provides the property value. `PropertyId` determines the data type of the value.

## Outputs

### Return Value

The return value indicates the status of the function call as a signed 32-bit integer. Zero means the function executed successfully. A negative value specifies an error, which means the function did not perform the expected behavior. A positive value specifies a warning, which means the function performed as expected, but a condition arose that may require attention.

Use the `ncStatusToString` function of the Frame API to obtain a descriptive string for the return value. The `ncStatusToString` and `ncGetHardwareInfo` functions are the only Frame API functions that can be called within a Channel API application.

## Description

You cannot set a property while the task is running. If you need to change a property prior to starting the task, you cannot use `nctInitStart`. First call `nctInitialize`, followed by `nctSetProperty`, and then `nctStart`. After you start the task, you also can change a property by calling `nctStop`, followed by `nctSetProperty`, and then `nctStart` again.

## Properties

**u32 nctPropBehavAfterFinalOut**

The `nctPropBehavAfterFinalOut` property applies only to tasks initialized with mode of `NctModeOutput`, and sample rate greater than zero. The value specifies the behavior to perform after the final periodic sample is transmitted.

`nctPropBehavAfterFinalOut` uses the following values:

**nctOutBehavRepeatFinalSample**

Transmit messages for the final sample(s) repeatedly. The final messages are transmitted periodically as specified by `SampleRate`.

If there is significant delay between subsequent calls to `nctWrite`, this value means periodic messages continue



between `nctWrite` calls, and messages with the data of the final sample are repeated on the network.

`nctOutBehavRepeatFinalSample` is the default value of the `nctPropBehavAfterFinalOut` property.

`nctOutBehavCeaseTransmit`

Cease transmit of messages until the next call to `nctWrite`.

If there is significant delay between subsequent calls to `nctWrite`, this value means periodic messages cease between `nctWrite` calls, and the data of the final sample is not repeated on the network.

f64 `nctPropChanDefaultValue`

Sets the default value of the channel in scaled floating-point units.

For information on how the `nctPropChanDefaultValue` is used, refer to the `nctRead` and `nctWrite` functions.

The value of this property is originally set within MAX. If the channel is initialized directly from a CAN database, the value is 0.0 by default, but it can be changed using `nctSetProperty`.

u32 `nctPropHwMasterTimebaseRate`

Sets the rate (in MHz) of the external clock that is exported to the CAN card.

The decimal values for this property are:

20

When synchronizing 2 CAN cards or synchronizing a CAN card with an E-Series DAQ card, the 20 MHz master timebase rate is to be used. By default, this property is set to 20 MHz.

10

The master timebase rate should be set to 10 MHz when synchronizing a CAN card with an M-Series DAQ card. The M-Series DAQ card can export a 20 MHz clock but it does this by using one of its two counters.

If your CAN-DAQ application does not use the 2 DAQ counters then, you can leave the timebase rate set to 20 MHz (default).

This property can be set either before or after calling `nctConnectTerminals` to connect the **RTSI\_CLK** to **Master Timebase**. However, this property must always be called prior to starting the task.

This property is applicable only to PCI and PXI Series 2 cards. For PCMCIA cards, setting this attribute will return an error. On PXI cards,

if **PXI\_CLK10** is routed to the **Master Timebase**, then the rate is fixed at 10 MHz (it over rides any previous setting of this property). Setting this property for Series 1 cards will also result in an NI-CAN error.

#### u32 nctPropHwTimestampFormat

Sets the format of the timestamps reported by the on-board timer on the CAN card. The default value for this property is `Absolute`.

The values for this property are:

##### 0 (Absolute)

Sets the timestamp format to absolute. In the absolute format, the timestamp returned by NI-CAN read functions is the LabVIEW date/time format (DBL representing the number of seconds elapsed since 12:00 a.m., Friday, January 1, 1904).

##### 1 (Relative)

Sets the timestamp format to relative. In the relative format, the timestamp returned by the NI-CAN read functions will be zero based (DBL representing the number of seconds since the CAN controller for that task was started).

A typical use case for this property would be if data received from two RTSI synchronized CAN cards is to be correlated. For that use case, this property must be set to 1 for all of the CAN cards being synchronized. Setting this property on one port of a 2-port card will also reset the timestamp of the second port, since resetting the timestamp on the CAN port involves resets the on-board timer.

This property should be set prior to starting any tasks on the CAN card.

#### u32 nctPropIntfBaudRate

Sets the baud rate in use by the `Interface`.

This property applies to all tasks initialized with the interface.

You can specify the following basic baud rates as the numeric rate: 33333, 83333, 100000, 125000, 200000, 250000, 400000, 500000, 800000, and 1000000.

You can specify advanced baud rates as 8000XXYY hex, where YY is the value of Bit Timing Register 0 (BTR0), and XX is the value of Bit Timing Register 1 (BTR1). For more information, refer to the **Port Properties** dialog in MAX.

The value of this property is originally set within MAX, but it can be changed using [nct SetProperty](#).

## u32 nctPropIntfListenOnly

Sets a Boolean value that indicates whether the listen only feature of the Philips SJA1000 CAN controller is enabled (1) or disabled (0).

This property applies to all tasks initialized with the `Interface`.

If `nctPropIntfListenOnly` is 0, the `Interface` can transmit CAN messages; therefore the `nctWrite` function operates normally. When CAN messages are received by the `Interface`, those messages are acknowledged. Because disabled (0) is the behavior specified in the CAN specification, it is the default value of `nctPropIntfListenOnly`.

If `nctPropIntfListenOnly` is 1, the `Interface` cannot transmit CAN messages; therefore the `nctWrite` function returns an error. When CAN messages are received by the `Interface`, those messages are not acknowledged. The Philips SJA1000 CAN controller enters error passive state when listen only is enabled (but no error-passive warning is returned). The enabled (1) value of `nctPropIntfListenOnly` enables passive monitoring of network traffic, which can be useful for debugging scenarios in which only one device exists on the network.

Since the listen only feature requires the Philips STA1000 CAN controller, this property is supported on Series 2 NI CAN hardware only. If you are using Series 1 NI CAN hardware, an attempt to set this property returns error code `CanErrRequiresSeries2`.

## u32 nctPropIntfSelfReception

Specifies whether to echo successfully transmitted CAN frames as received frames. Each reception occurs just as if the frame were received from another CAN device. This enables you to initialize the same channels for both input and output.

For self reception to operate properly, another CAN node must receive and acknowledge each transmit.

False disables self reception mode (default), and True enables self reception mode.

The self reception mode is not available on the Intel 82527 CAN controller used by Series 1 CAN hardware. For Series 1 hardware, this property must be left at its default (False).

## u32 nctPropIntfSeries2Comp

Specifies the filter comparator for the Philips SJA1000 CAN controller on all Series 2 CAN hardware. This property is not supported for Series 1 hardware (returns error).

This property specifies a comparator value that is checked against the ID, RTR, and data bits. The `nctPropIntfSeries2Mask` determines the applicable bits for comparison.

The default value of this property is zero.

The mapping of bits in this property to the ID, RTR, and data bits of incoming frames is determined by the value of the `nctPropIntfSeries2FilterMode` property. The Series 2 filter mode determines the format of this property as well as the Series 2 mask.

#### u32 `nctPropIntfSeries2FilterMode`

All Series 2 hardware uses the Philips SJA1000 CAN controller. The Philips SJA1000 CAN controller provides sophisticated filtering of received frames. This property specifies the filtering mode, which is used in conjunction with the `nctPropIntfSeries2Mask` and `nctPropIntfSeries2Comp` properties.

This property is not supported for Series 1 hardware (returns error).

Since the format of the Series 2 filters is very specific to the Philips SJA1000 CAN controller, National Instruments cannot guarantee compatibility for this property on future hardware series. When using this property in the application, it is best to get the `nctPropHwSeries` property to verify that the CAN hardware is Series 2.

The filtering specified by the Series 2 filter properties applies to all input tasks for that interface. For example, if you specify filters that discard ID 5, then open an Input task to receive channels of ID 5, the task will not receive data. The default value for this property is `nctFilterSingleStandard`.

The values for this property are summarized below. For detailed information on each value, including the format of the `nctPropIntfSeries2Mask` and `nctPropIntfSeries2Comp` properties for each mode, refer to the `NC_ATTR_SERIES2_FILTER_MODE` attribute in the `ncConfig` function of the Frame API.

#### `nctFilterSingleStandard` (Single Standard)

Filter all standard (11-bit) frames using a single mask/comparator filter.

#### `nctFilterSingleExtended` (Single Extended)

Filter all extended (29-bit) frames using a single mask/comparator filter.

`nctFilterDualStandard` (Dual Standard)

Filter all standard (11-bit) frames using a two separate mask/comparator filters. If either filter matches the frame, it is received. The frame is discarded only when neither filter detects a match.

`nctFilterDualExtended` (Dual Extended)

Filter all extended (29-bit) frames using a two separate mask/comparator filters. If either filter matches the frame, it is received. The frame is discarded only when neither filter detects a match.

`u32 nctPropIntfSeries2Mask`

Specifies the filter mask for the Philips SJA1000 CAN controller on all Series 2 CAN hardware. This property is not supported for Series 1 hardware (returns error).

This property specifies a bit mask that determines the ID, RTR, and data bits that are compared. If a bit is clear in the mask, the corresponding bit in the `nctPropIntfSeries2Comp` is checked. If a bit in the mask is set, that bit is ignored for the purpose of filtering (don't care).

The default value of this property is hex FFFFFFFF, which means that all messages are received.

The mapping of bits in this property to the ID, RTR, and data bits of incoming frames is determined by the value of the `nctPropIntfSeries2FilterMode` property. The Series 2 filter mode determines the format of this property as well as the Series 2 comparator.

`u32 nctPropIntfSingleShotTx`

Specifies whether to retry failed CAN frame transmissions (Series 2 only).

If `nctPropIntfSingleShotTx` is 0 (default), failed transmissions retry as defined in the CAN specification. If a CAN frame is not transmitted successfully, the CAN controller will immediately retry.

If `nctPropIntfSingleShotTx` is 1, all transmissions are single shot. If a CAN frame is not transmitted successfully, the CAN controller will not retry.

The single-shot transmit feature is not available on the Intel 82527 CAN controller used by Series 1 CAN hardware (returns error).

u32 `nctPropIntfTransceiverExternalOut`

Sets the transceiver external outputs for the interface that was initialized for the task.

Series 2 XS cards enable connection of an external transceiver. For an external transceiver, this property allows you to set the output voltage on the MODE0 and MODE1 pins of the CAN port, and it allows you control the sleep mode of the on-board CAN controller chip.

For many models of CAN transceiver, EN and NSTB pins control the transceiver mode, such as whether the transceiver is sleeping, or communicating normally. For such transceivers, you can wire the EN and NSTB pins to the MODE0 and MODE1 pins of the CAN port.

The default value of this property is 00000003 hex. For many models of transceiver, this specifies normal communication mode for the transceiver and CAN controller chip. If the transceiver requires a different MODE0/MODE1 combination for normal mode, you can use external inverters to change the default 5 V to 0 V.

This property is supported for Series 2 XS cards only. This property is not supported when the `nctPropIntfTransceiverType` property is any value other than External. To control the mode of an internal transceiver, use the `nctPropIntfTransceiverMode` property.

This property uses a bit mask. Use bitwise OR operations to set multiple values.

`nctTransceiverOutMode0` (00000001 hex, MODE0 pin)

Set this bit to drive 5 V on the MODE0 pin. This is the default value. This bit is set automatically when a remote wakeup is detected.

Clear this bit to drive 0 V on the MODE0 pin.

`nctTransceiverOutMode1` (00000001 hex, MODE1 pin)

Set this bit to drive 5 V on the MODE1 pin. This is the default value. This bit is set automatically when a remote wakeup is detected.

Clear this bit to drive 0 V on the MODE1 pin.

`nctTransceiverOutSleep` (00000100 hex, Sleep CAN controller chip)

Set this bit to place the CAN controller chip into sleep mode. This bit controls the mode of the CAN controller chip (sleep or normal), and the independent MODE0/MODE1 bits control the mode of the external transceiver. When you set this bit to place the CAN controller into sleep mode, you

typically specify MODE0/MODE1 bits that place the external transceiver into sleep mode as well.

When the CAN controller is asleep, a remote wakeup will automatically place the CAN controller into its normal mode of communication. In addition, the MODE0/MODE1 pins are restored to their default values of 5 V. Therefore, a remote wakeup causes this property to change from the value that you set for sleep mode, back to its default 00000003 hex. You can determine when this has occurred by getting `nctPropIntfTransceiverExternalOut` using `nctGetProperty`. For more information on remote wakeup, refer to the `nctPropIntfTransceiverMode` property for internal transceivers.

Clear this bit to place the CAN controller chip into normal communication mode. If the CAN controller was previously in sleep mode, this performs a local wakeup to restore communication.

u32 `nctPropIntfTransceiverMode`

Sets the transceiver mode for the interface that was initialized for the task. The transceiver mode controls whether the transceiver is asleep or communicating, as well as other special modes.

This property is supported on Series 2 cards only.

For Series 2 cards for the PCMCIA form factor, this property requires a corresponding Series 2 cable (dongle). For information on how to identify the series of the PCMCIA cable, refer to the [Series 2 Vs. Series 1](#) section of Chapter 1, [Introduction](#).

For Series 2 XS cards, this property is not supported when the `nctPropIntfTransceiverType` property is External. To control the mode of an external transceiver, use the `nctPropIntfTransceiverExternalOut` property.

The default value for this property is Normal.

This property uses the following values:

`nctTransceiverModeNormal`

Set transceiver to normal communication mode. If you set Sleep mode previously, this performs a local wakeup of the transceiver and CAN controller chip.

`nctTransceiverModeSleep`

Set transceiver and the CAN controller chip to sleep (or standby) mode.

If the transceiver supports multiple sleep/standby modes, the NI CAN hardware implementation ensures that all of those modes are equivalent with regard to the behavior of the transceiver on the network. For more information on the physical specifications for the normal and sleep modes of each transceiver, refer to Chapter 3, *NI CAN and LIN Hardware*.

You can set Sleep mode only while the interface is communicating. If at least one task for the interface has not been started (such as with `nctStart`), setting the transceiver mode to Sleep will return an error.

When the interface enters sleep mode, communication is not possible until a wakeup occurs. All pending frame transmissions are deferred until the wakeup occurs. The transceiver and CAN controller wake from sleep mode when either a local wakeup or remote wakeup occurs.

If you set Sleep mode when the CAN controller is actively transmitting a frame (that is, won arbitration), the interface will not enter Sleep mode until the frame is transmitted successfully (acknowledgement detected).

A *local wakeup* occurs when the application sets the transceiver mode to Normal (or some other communication mode).

A *remote wakeup* occurs when a remote node transmits a CAN frame (referred to as the wakeup frame). The wakeup frame wakes up the transceiver and CAN controller chip of the NI CAN interface. The wakeup frame is not received or acknowledged by the CAN controller chip. When the wakeup frame ends, the NI CAN interface enters Normal mode, and again receives and transmits CAN frames. If the node that transmitted the wakeup frame did not detect an acknowledgement (such as if other nodes were also waking), it will retry the transmission, and the retry will be received by the NI CAN interface.

For a remote wakeup to occur for Single Wire transceivers, the node that transmits the wakeup frame must first place the network into the Single Wire Wakeup Transmission mode by asserting a higher voltage (typically 12 V). For more information, refer to the `nctTransceiverModeSwwakeup` mode.

When the local or remote wakeup occurs, frame transmissions resume from the point at which the original Sleep was set.

You can detect when a remote wakeup occurs by using `nctGetProperty` with the `nctPropIntfTransceiverMode` property.



`nctTransceiverModeSWWakeup`

Set Single Wire transceiver to Wakeup Transmission mode.

This mode is supported on Single Wire (SW) ports only.

The Single Wire Wakeup Transmission mode drives a higher voltage level on the network to wakeup all sleeping nodes. Other than this higher voltage, this mode is similar to Normal mode. CAN frames can be received and transmitted normally.

Since you use the Single Wire Wakeup mode to wakeup other nodes on the network, it is not typically used in combination with Sleep mode for a given interface.

The timing of how long the wakeup voltage is driven is controlled entirely by the application. The application will typically change to Single Wire Wakeup mode, transmit a wakeup frame, then return to Normal mode.

The following sequence demonstrates a typical sequence of steps for sleep and wakeup between two Single Wire NI CAN interfaces. The sequence assumes that CAN0 is the sleeping node, and CAN1 originates the wakeup.

1. Start both CAN0 and CAN1. Both use the default Normal mode.
2. Set `nctPropIntfTransceiverMode` of CAN0 to Sleep.
3. Set `nctPropIntfTransceiverMode` of CAN1 to Single Wire Wakeup.
4. Write data to CAN1 to transmit a wakeup frame to CAN0.
5. Set `nctPropIntfTransceiverMode` of CAN1 to Normal.
6. Now both CAN0 and CAN1 are in Normal mode again.

`nctTransceiverModeSWHighSpeed`

Set Single Wire transceiver to High-Speed Transmission mode.

This mode is supported on Single Wire (SW) ports only.

The Single Wire High-Speed Transmission mode disables the internal waveshaping function of the transceiver, which allows baud rates up to 100 kbytes/s to be used. The disadvantage versus Normal (which allows up to 40 kbytes/s baud) is degraded EMC performance. Other than the disabled waveshaping, this mode is similar to Normal mode. CAN frames can be received and transmitted normally.

This mode has no relationship to High-Speed (HS) transceivers. It is merely a higher speed mode of the Single Wire (SW) transceiver, typically used for downloading large amounts of data to a node.

The Single Wire transceiver does not support use of this mode in conjunction with Sleep mode. For example, a remote wakeup cannot transition from Sleep to this Single Wire High-Speed mode.

#### u32 nctPropIntfTransceiverType

For XS software selectable physical layer cards that provide a software-switchable transceiver, the `nctPropIntfTransceiverType` property sets the type of transceiver. When the transceiver is switched from one type to another, NI-CAN ensures that the switch is undetectable from the perspective of other nodes on the network.

The default value for this property is specified within MAX. If you change the transceiver type in MAX to correspond to the network in use, you can avoid setting this property within the application.

This property applies to all tasks initialized with the same interface.

You cannot set this property for Series 1 hardware, or for Series 2 hardware other than XS (fixed HS, LS, or SW cards).

This property uses the following values:

`nctTransceiverTypeHS`

Switch the transceiver to High-Speed (HS).

`nctTransceiverTypeLS`

Switch the transceiver to Low-Speed/Fault-Tolerant (LS).

`nctTransceiverTypeSW`

Switch the transceiver to Single Wire (SW).

`nctTransceiverTypeExternal`

Switch the transceiver to External. The External type allows you to connect a transceiver externally to the interface. For more information on connecting transceivers externally, refer to Chapter 3, *NI CAN and LIN Hardware*.

When this transceiver type is selected, you can use the `nctPropIntfTransceiverExternalOut` and `nctPropIntfTransceiverExternalIn` properties to access the external mode and status pins of the connector.

nctTransceiverTypeDisconnect

Disconnect the CAN controller chip from the connector. This value is used when you physically switch an external transceiver. You first set `nctPropIntfTransceiverType` to `nctTransceiverTypeDisconnect`, then switch from one external transceiver to another, then set `nctPropIntfTransceiverType` to `nctTransceiverTypeExternal`. For more information on connecting transceivers externally, refer to Chapter 3, *NI CAN and LIN Hardware*.

u32 nctPropIntfVirtualBusTiming

Sets the Virtual Bus Timing of the virtual device.

The values for this property are:

FALSE (0)

Virtual Bus Timing is turned off. By turning Virtual Bus Timing off, the CAN bus simulation is disabled and CAN frames are copied from the write queue of one virtual interface to the read queue of the second virtual interface. This setting is useful if you desire to only convert frames to channels or vice versa and not simulate actual CAN bus communication.

TRUE (1)

Virtual Bus Timing is turned on (default). By turning Virtual Bus Timing on, frame timestamps are recalculated as they transfer across the virtual bus. This mode is useful when you want the virtual bus to behave as much like a real bus as possible.

If this property is set on real hardware, an error will be returned.

The Virtual Bus Timing has to be set to the same value on both virtual interfaces. This property must be set prior to starting the virtual interface.

Refer to the *Frame to Channel Conversion* section of Chapter 6, *Using the Channel API* for more information.

u32 nctPropMsgDistribution

Sets the `nctPropMsgDistribution` property which is used to determine if the CAN frames associated with a group of mode dependent channels are sent even-spaced or in burst mode.

nctDistrUniform

Transmits mode dependent messages uniformly (evenly spaced) on the network.

`nctDistrBurst`

Transmits mode dependent messages back to back on the network.

This property applies only to mode dependent channels that are transmitted periodically. For more information, refer to the *Mode Dependent Channels* section of Chapter 6, *Using the Channel API*.

f64 `nctPropNoValue`

Sets the value that is returned on timestamped read for mode dependent channels that have not been received with the most recent CAN frame associated with the CAN message. This property applies only to mode dependent channels that are read with the timestamped read operation. For more information, refer to the *Mode Dependent Channels* section of Chapter 6, *Using the Channel API*.

f64 `nctPropTimeout`

Sets a time in milliseconds to wait for samples. The default value is zero.

For all task configurations, `nctPropTimeout` specifies the time that Read will wait for the start trigger. If the application does not use `nctConnectTerminals`, the start trigger occurs when the task starts (`nctStart`). If you connect a start trigger from a RTSI line or other source, `nctPropTimeout` specifies the number of milliseconds to wait. `nctPropTimeout` of zero means to wait up to 10 seconds for the start trigger.

Usage of the `nctPropTimeout` property depends on the initialized mode of the task:

- `NctModeOutput`: For each `NctModeOutput` task, NI-CAN uses a buffer to store samples for transmit. If the number of samples you provide to `nctWrite` exceeds the size of the underlying buffer, NI-CAN waits for sufficient space to become available (due to successful transmits). The `nctPropTimeout` specifies the number of milliseconds to wait for available buffer space. Timeout of zero means to wait up to 10 seconds.
- `NctModeInput`: The timeout value does *not* apply. For `NctModeInput` tasks initialized with `SampleRate` greater than zero, the `NumberOfSamplesToRead` input to `nctRead` implicitly specifies the time to wait. For `NctModeInput` tasks initialized with `SampleRate` equal to zero, the `nctRead` function always returns available samples immediately, without waiting.

- `NctModeTimestampedInput`: A timeout of zero means to return available samples immediately. A timeout greater than zero means `nctRead` will wait a maximum of `nctPropTimeout` milliseconds for `NumberOfSamplesToRead` samples to become available before returning.
- `NctModeOutputRecent`: The timeout value does not apply.

## nctStart

---

### Purpose

Start communication for the specified task.

### Format

```
nctTypeStatus nctStart (
    nctTypeTaskRef TaskRef,
```

### Inputs

TaskRef

Task reference from the previous NI-CAN function. The task reference is originally returned from functions such as [nctInitialize](#) or [nctCreateMessage](#).

### Outputs

#### Return Value

The return value indicates the status of the function call as a signed 32-bit integer. Zero means the function executed successfully. A negative value specifies an error, which means the function did not perform the expected behavior. A positive value specifies a warning, which means the function performed as expected, but a condition arose that may require attention.

Use the [ncStatusToString](#) function of the Frame API to obtain a descriptive string for the return value. The [ncStatusToString](#) and [ncGetHardwareInfo](#) functions are the only Frame API functions that can be called within a Channel API application.

### Description

You must start communication for a task to use [nctRead](#) or [nctWrite](#). After you start communication, you can no longer change the configuration of the task with [nctSetProperty](#) or [nctConnectTerminals](#).

## nctStop

---

### Purpose

Stop communication for the specified task.

### Format

```
nctTypeStatus nctStop(
    nctTypeTaskRef TaskRef,
```

### Inputs

TaskRef

Task reference from the previous NI-CAN function. The task reference is originally returned from [nctInitStart](#), [nctInitialize](#), or [nctCreateMessage](#).

### Outputs

#### Return Value

The return value indicates the status of the function call as a signed 32-bit integer. Zero means the function executed successfully. A negative value specifies an error, which means the function did not perform the expected behavior. A positive value specifies a warning, which means the function performed as expected, but a condition arose that may require attention.

Use the [ncStatusToString](#) function of the Frame API to obtain a descriptive string for the return value. The [ncStatusToString](#) and [ncGetHardwareInfo](#) functions are the only Frame API functions that can be called within a Channel API application.

### Description

This function stops communication so you can change the configuration of the task, such as by using [nctSetProperty](#) or [nctConnectTerminals](#). After you change the configuration, use [nctStart](#) to start again.

This function does not clear the configuration for the task; therefore, do *not* use it as the last NI-CAN function in the application. The [nctClear](#) function must always be used as the last NI-CAN function for each task.

## nctWrite

---

### Purpose

Write samples to a CAN task initialized as `NctModeOutput`. Samples are placed into transmitted CAN messages. For an overview of `nctWrite`, refer to the [Write](#) section of Chapter 6, *Using the Channel API*.

### Format

```
nctTypeStatus  nctWrite(
                nctTypeTaskRef  TaskRef,
                u32               NumberOfSamplesToWrite,
                f64               *SampleArray);
```

### Inputs

`TaskRef`

Task reference from the previous NI-CAN function. The task reference is originally returned from `nctInitStart`, `nctInitialize`, or `nctCreateMessage`.

The Mode initialized for the task must be `NctModeOutput`.

`NumberOfSamplesToWrite`

Specifies the number of samples to write for the task.

For single-sample output, pass 1 to this parameter.

`SampleArray`

Provides an array of arrays (2D array), one array for each channel initialized in the task. The array of each channel must have `NumberOfSamplesToWrite` samples.

For example, if you call `nctInitStart` with `ChannelList` of `mych1, mych2, mych3`, then call `nctWrite` with `NumberOfSamplesToWrite` of 10, `SampleArray` must be allocated as:

```
f64 SampleArray[3][10];
```

You must provide a valid sample value in each entry of the arrays.

The order of channel entries in `SampleArray` is the same as the order in the original channel list.



To determine the number of channels in the task after initialization, get the `nctPropNumChannels` property for the task reference.

## Outputs

### Return Value

The return value indicates the status of the function call as a signed 32-bit integer. Zero means the function executed successfully. A negative value specifies an error, which means the function did not perform the expected behavior. A positive value specifies a warning, which means the function performed as expected, but a condition arose that may require attention.

Use the `ncStatusToString` function of the Frame API to obtain a descriptive string for the return value. The `ncStatusToString` and `ncGetHardwareInfo` functions are the only Frame API functions that can be called within a Channel API application.

## Description

The associated `ChannelList` determines the messages transmitted by `nctWrite`. If all channels are contained in a single message, only that message is transmitted. If a few channels are contained in one message, and the remaining channels are contained in a second message, then two messages are transmitted.

If the initialized sample rate is greater than zero, the task transmits associated CAN messages periodically at the specified rate. The first `nctWrite` transmits associated messages immediately using the first sample in the array of each channel, and then begins a periodic timer at the specified rate. Each subsequent transmission of messages is based on the timer, and uses the next sample in the array of each channel. After the final sample in the array of each channel has been transmitted, subsequent behavior is determined by the `nctPropBehavAfterFinalOut` property. The default `nctPropBehavAfterFinalOut` behavior is to retransmit the final sample each period until `nctWrite` is called again.

If the initialized `SampleRate` is zero, the task transmits associated messages immediately for each entry in the array of each channel, with as little delay as possible between messages. After the message for the final sample is transmitted, no further transmissions occur until `nctWrite` is called again, regardless of the `nctPropBehavAfterFinalOut` property.

Because all channels of a message are transmitted on the network as a unit, `nctWrite` enforces the following rules:

- You *cannot* write the same message in more than one `NctModeOutput` task.
- You *can* write more than one message in a single `NctModeOutput` task.
- You *can* write a subset of channels for a message in a single `NctModeOutput` task. For channels that are not included in the task, the channel default value (`nctPropChanDefaultValue`) is transmitted in the CAN message.

For many applications, the most straightforward technique is to assign a single `NctModeOutput` task for each message you want to transmit. In each task, include all channels of that message in the `ChannelList`. This ensures you can provide new samples for the entire message with each `nctWrite`.

---

# Using the Frame API

This chapter provides information to help you get started with the Frame API.

## Choose Which Objects To Use

---

An application written for the NI-CAN Frame API communicates on the network by using various objects. Which Frame API objects to use depends largely on the needs of the application. The following sections discuss the objects provided by the Frame API, and reasons why you might use each class of object.

### Using CAN Network Interface Objects

The CAN Network Interface Object encapsulates a physical interface to a CAN network, usually a CAN port on an AT, PCI, PCMCIA, PXI, or USB card.

You use the CAN Network Interface Object to read and write complete CAN frames. As a CAN frame arrives from over the network, it can be placed into the read queue of the CAN Network Interface Object. You can retrieve CAN frames from this read queue using the `ncRead` or `ncReadMult` function. The read functions provide a timestamp of when the frame was received, the arbitration ID of the frame, the type of frame (data, remote, or RTSI), the data length, and the data bytes. You also can use the CAN Network Interface Object to write CAN frames using the `ncWrite` function.

Some possible uses for the CAN Network Interface Object include the following:

- You can use the read queue to log all CAN frames transferred across the network. This log is useful when you need to view CAN traffic to verify that all CAN devices are functioning properly.
- You can use the write queue to transmit a sequence of CAN frames in quick succession.

- You can read and write CAN frames for access to configuration settings within a device. Because such settings generally are not accessed during normal device operation, a dedicated CAN Object is not appropriate.
- For higher level protocols based on CAN, you can use sequences of write/read transactions to initialize communication with a device. In these protocols, specific sequences of CAN frames often need to be exchanged before you can access the data from a device. In such cases, you can use the CAN Network Interface Object to set up communication, then use CAN Objects for actual data transfer with the device.
- The USB-847x hardware uses only the Network Interface Objects for communication.

In general, you use CAN Network Interface Objects for situations in which you need to transfer arbitrary CAN frames.

## Using LIN Network Interface Objects

The LIN Network Interface Object encapsulates a physical interface to a LIN network, such as a LIN port on a USB-LIN device. You use the LIN Network Interface Object to read and write NI LIN frame types. As a LIN frame arrives from over the network, it can be placed into the read queue of the LIN Network Interface Object.

You can retrieve LIN frames from this read queue using the **ncRead** or **ncReadMult** function. The read functions provide a timestamp of when the frame was received, the arbitration ID of the frame, the type of frame (full, bus inactive, wakeup received, or bus error), the data length, and the data bytes. You also can use the LIN Network Interface Object to write any of three NI LIN frame types (response entry, header, or full), using the **ncWrite** or **ncWriteMult** function.

Some possible uses for the LIN Network Interface Object include the following:

- You can use the read queue and the LIN device in slave mode, to log all LIN frames transferred across the network. This log is useful when you need to view LIN traffic to verify that all LIN devices are functioning properly.
- You can use the write and read queues and the LIN device in slave mode, to emulate one or more slave nodes.
- You can use the write queue and the LIN device in master mode, to transmit a sequence of LIN frames in quick succession.

- You can loop individual writes with a variable delay between each, and the LIN device in master mode, to emulate LIN descriptor file (LDF) control of scheduling of LIN traffic.

## Using CAN Objects

The CAN Object encapsulates a specific CAN arbitration ID and its associated data.

Every CAN Object is always associated with a specific CAN Network Interface Object, used to identify the physical interface on which the CAN Object is located. The application can use multiple CAN Objects in conjunction with their associated CAN Network Interface Object.

The CAN Object provides high-level access to a specific arbitration ID. You can configure each CAN Object for different forms of background access. For example, you can configure a CAN Object to transmit a data frame every 100 milliseconds, or to periodically poll for data by transmitting a remote frame and receiving the data frame response. The arbitration ID, direction of data transfer, data length, and when data transfer occurs (periodic or unsolicited) are all preconfigured for the CAN Object. When you have configured and opened the CAN Object, data transfer is handled in the background using read and write queues. For example, if the CAN Object periodically polls for data, the NI-CAN driver automatically handles the periodic transmission of remote frames, and stores incoming data in the read queue of the CAN Object for later retrieval by the `ncRead` function. For CAN Objects that receive data frames, the `ncRead` function provides a timestamp of when the data frame arrived, and the data bytes of the frame. For CAN Objects that transmit data frames, the `ncWrite` function provides the outgoing data bytes.

Some possible uses for CAN Objects include the following:

- You can configure a CAN Object to periodically transmit a data frame for a specific arbitration ID. The CAN Object transmits the same data bytes repetitively until different data is provided using `ncWrite`.
- You can configure a CAN Object to watch for unsolicited data frames received for its arbitration ID, then store that data in the read queue of the CAN Object. A watchdog timeout is provided to ensure that incoming data is received periodically. This configuration is useful when you want to apply a timeout to data received for a specific arbitration ID and store that data in a dedicated queue. If you do not need to apply a timeout for a given arbitration ID, it is preferable to use the CAN Network Interface Object to receive that data.

- You can configure a CAN Object to periodically poll for data by transmitting a remote frame and receiving the data frame response. This configuration is useful for communication with devices that require a remote frame to transmit their data.
- You can configure a CAN Object to transmit a data frame whenever it receives a remote frame for its arbitration ID. You can use this configuration to simulate a device which responds to remote frames.

In general, you use CAN Objects for data transfer for a specific arbitration ID, especially when that data transfer needs to occur periodically.

## Frame API Basic Programming Model for CAN

---

The following steps demonstrate how to use the Frame API functions in an application. The steps are shown in Figure 9-1, [Programming Model for NI-CAN Frame API](#).

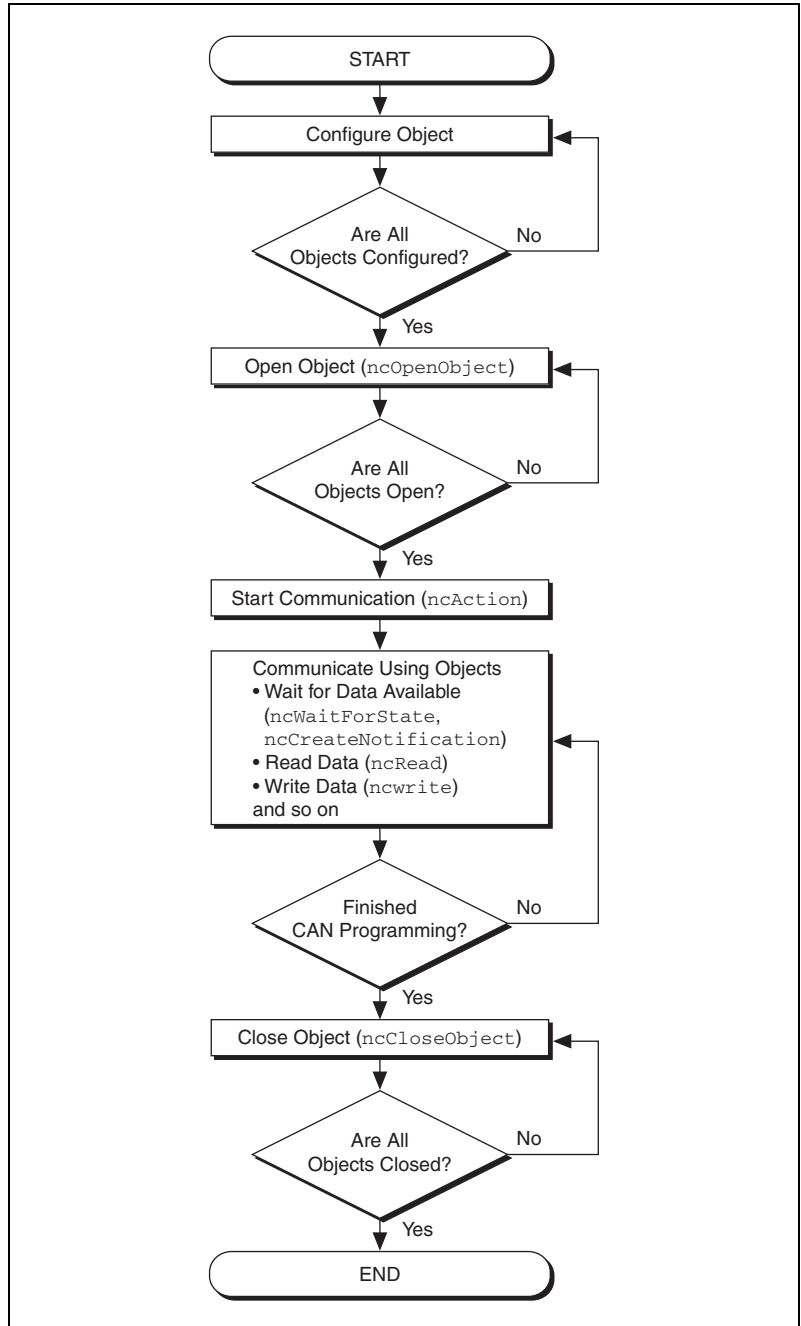

**Figure 9-1.** Programming Model for NI-CAN Frame API

1. Configure Objects.

Prior to opening the objects used in the application, you must configure the objects with their initial attribute settings. Each object is configured within the application by calling the `ncConfig` function. This function takes the name of the object to configure, along with a list of configuration attribute settings.

2. Open Objects.

You must call the `ncOpen` function to open each object you use within the application.

The `ncOpen` function returns a handle for use in all subsequent Frame API calls for that object. When you are using the LabVIEW function library, this handle is passed through the upper left and right terminals of each Frame API function used after the open.

3. Start Communication.

You must start communication on the CAN network before you can use the objects to transfer data.

If you configured the CAN Network Interface Object to start on open, that object and all of its higher level CAN Objects are started automatically by the `ncOpen` function, so nothing special is required for this step.

If you disabled the start-on-open attribute, when the application is ready to start communication, use the CAN Network Interface Object to call the `ncAction` function with the `OpCode` parameter set to `NC_OP_START`. This call is often useful when you want to use `ncWrite` to place outgoing data in write queues prior to starting communication. This call is also useful in high bus load situations, because it is more efficient to start communication after all objects have been opened.

4. Communicate Using Objects

After you open the objects and start communication, you are ready to transfer data on the CAN network. The manner in which data is transferred depends on the configuration of the objects you are using. For this example, assume that you are communicating with a CAN device that periodically transmits a data frame. To receive this data, assume that a CAN Object is configured to watch for data frames received for its arbitration ID and store that data in its read queue.

#### **4a. Wait for Available Data**

To wait for the arrival of a data frame from the device, you can call `ncWaitForState` with the `DesiredState` parameter set to `NC_ST_READ_AVAIL`. The `NC_ST_READ_AVAIL` state tells you that



data for the CAN Object has been received from the network and placed into the read queue of the object.

When receiving data from the device, if the only requirement is to obtain the most recent data, you are not required to wait for the `NC_ST_READ_AVAIL` state. If this is the case, you can set the read queue length of the CAN Object to zero during configuration, so that it only holds the most recent data bytes. Then you can use the `ncRead` function as needed to obtain the most recent data bytes received.

#### 4b. Read Data

Read the data bytes using `ncRead`. For CAN Objects that receive data frames, `ncRead` returns a timestamp of when the data was received, followed by the actual data bytes (the number of which you configured in step 1).

Steps 4a and 4b should be repeated for each data value you want to read from the CAN device.

#### 5. Close Objects.

When you are finished accessing the CAN devices, close all objects using the `ncClose` function before you exit the application.

## Frame API Basic Programming Model for LIN

---

This section describes the Frame API programming model for LIN.

### LIN Interface as Bus Monitor

The following steps demonstrate how to use the Frame API functions with a LIN application in which the LIN interface is acting as a bus monitor. The steps are shown in the flowchart in Figure 9-2, *Frame API with LIN Interface as Bus Monitor*.

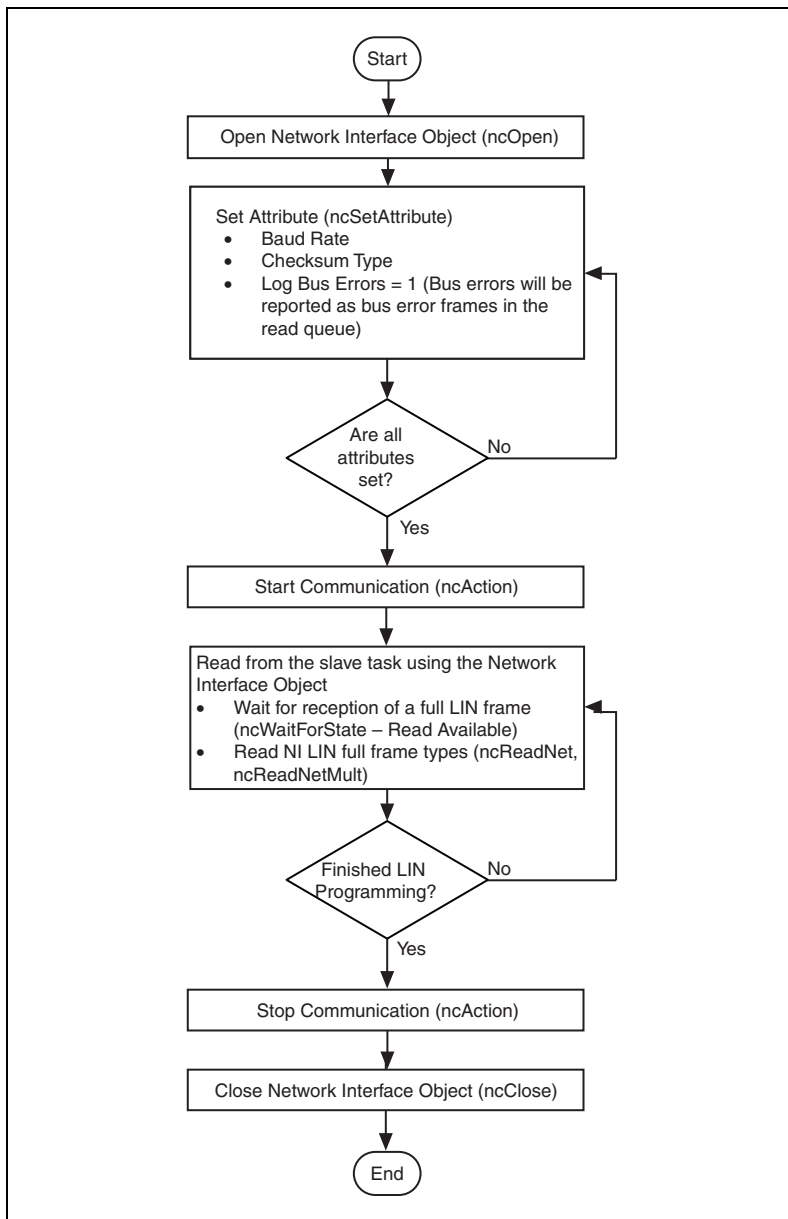

Figure 9-2. Frame API with LIN Interface as Bus Monitor

1. Open a Network Interface Object.

You must call the `ncOpenObject` function to open the Network Interface Object used in this example.

The `ncOpenObject` function returns a handle for use in all subsequent Frame API calls for that object. When you are using the LabVIEW function library, this handle is passed through the upper left and right terminals of each Frame API function used after the open.

2. Set attribute(s) for the Network Interface Object.

Prior to starting the Network Interface Object, you must configure it with its initial attribute settings. These are configured by calling the `ncSetAttribute` function with each desired attribute ID and value. This function takes the name of the object to configure, along with the attribute ID and value.

For this example, the baud rate and checksum type should be configured to match those of the LIN. Logging of bus errors is useful for troubleshooting, in the event any of the devices attached to the LIN do not behave as expected.

3. Start communication.

You must start communication on the LIN bus before you can use the Network Interface Object to transfer data.

4. Read from the slave task using the Network Interface Object.

By default, the NI LIN interface will subscribe to data in response to all headers received from the bus. Upon successful reception of response data and checksum for a header, the slave task will combine the header and response data into a single full frame and load it into the read queue. If log bus errors is enabled, then the first bus error that occurs within the header or response portion of each LIN frame will be placed into a bus error frame and loaded into the read queue. The LIN interface slave task will ignore the remainder of the frame transaction on the bus and prepare for the reception of the next header. The loading of the full or bus error frame into the read queue will set a read available flag in the interface. `ncWaitForState` should be used to wait for read available before executing the `ncRead` or `ncReadMult` function. Step 4 should be repeated for monitoring situations, as the read queue is being continuously filled with LIN frame data resulting from bus transactions initiated by an external master.

5. Stop communication.

Stop communication on the LIN bus before closing the Network Interface Object.

6. Close the Network Interface Object.

When you are finished accessing the LIN bus, close the Network Interface Object using the `ncCloseObject` function before you exit the application.

## LIN Interface as Master

The following steps demonstrate how to use the Frame API functions in a LIN application in which the LIN interface is emulating a master device executing the behavior specified in an LDF. The steps are shown in Figure 9-3, *Frame API – LIN interface emulating a master executing the behavior specified in an LDF*.

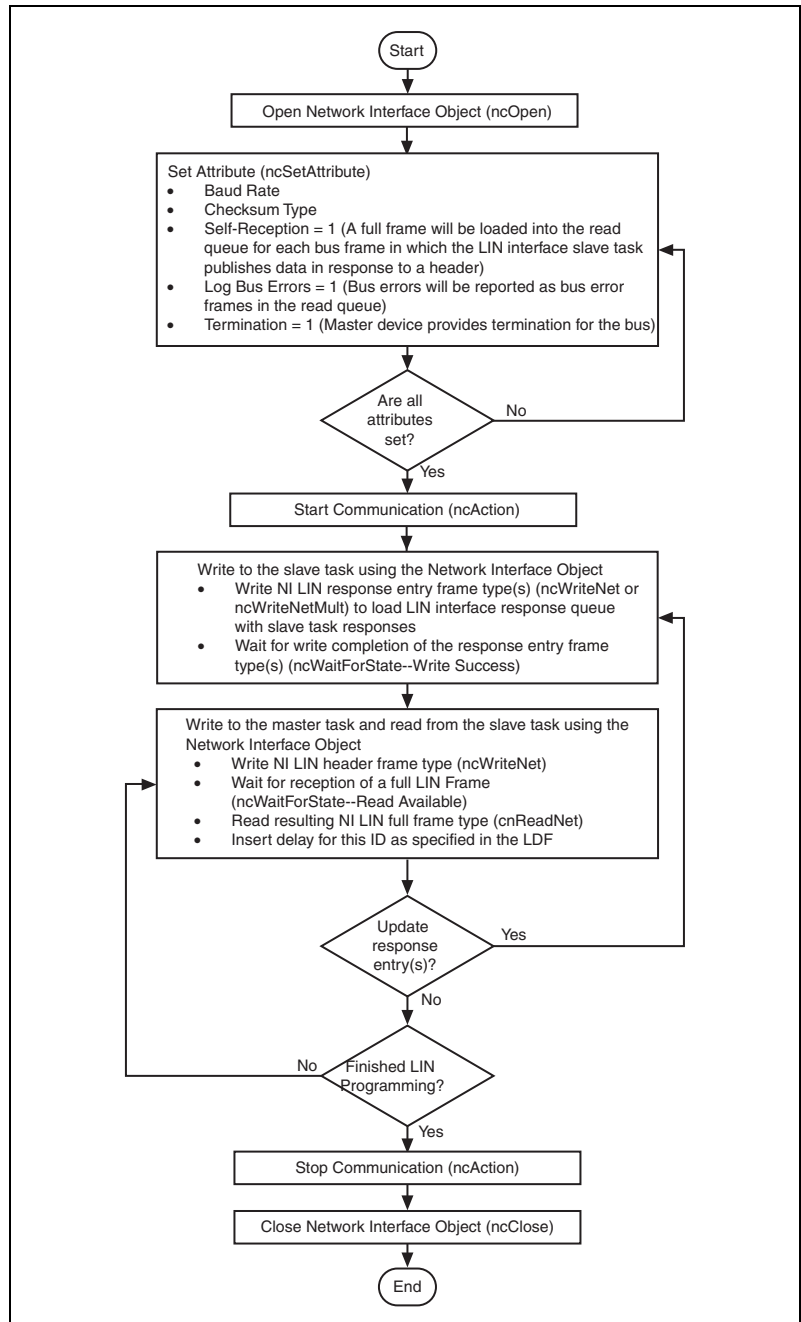

**Figure 9-3.** Frame API – LIN interface emulating a master executing the behavior specified in an LDF

1. Open a Network Interface Object.

You must call the `ncOpenObject` function to open the Network Interface Object used in this example.

The `ncOpenObject` function returns a handle for use in all subsequent Frame API calls for that object. When you are using the LabVIEW function library, this handle is passed through the upper left and right terminals of each Frame API function used after the open.

2. Set attributes for the Network Interface Object.

Prior to starting the Network Interface Object, you must configure it with its initial attribute settings. These are configured by calling the `ncSetAttribute` function with each desired attribute ID and value. This function takes the name of the object to configure, along with the attribute ID and value.

For this example, the baud rate and checksum type should be configured to match those of the LIN being accessed. Self-reception is shown as enabled but it is optional. When the slave task publishes data, the resulting full frame is logged into the read queue only if self-reception is enabled. In other words, if the response queue is loaded with three entries that publish in response and two entries that subscribe in response, then only the resulting full frames for the IDs of the two subscribing entries will be logged if self-reception is disabled. If self-reception is enabled, then the resulting full frames for the IDs of all five entries will be logged. Logging of bus errors is useful for troubleshooting, in the event the slave device does not behave as expected. Since the LIN interface is emulating the master device, termination should be enabled.

3. Start Communication.

You must start communication on the LIN bus before you can use the Network Interface Object to transfer data.

4. Write to the slave task using the Network Interface Object.

Write response entry frames to the LIN interface slave task in order to configure how it will respond to the ID in each header transmitted by the master task. If it should subscribe to data in response to a header ID, then the DLC should be set to 0 and the data bytes don't care. If it should publish in response to a header ID, then the DLC should be in the range of one to eight with the data bytes containing the actual data to publish. If you are using an LDF, then it will define the behavior of each slave task (including the slave task in the master node), regarding its response to each header. Write completion of the response entry frame types will set a write success flag in the interface.

`ncWaitForState` should be used to wait for write success following the write.

5. Write to the master task and read from the slave task using the Network Interface Object.

In this example, the NI LIN interface is acting as a master node. Thus, after the initial response entries have been loaded into the slave task response queue (step 4), you can issue the first header on the bus by writing a header frame type to the LIN interface. Per the *LIN 2.0 Specification*, the LIN interface master task handles processing of the header frame type and subsequent transmission of the header onto the LIN.

As a result of the LIN interface master task transmitting a header, the LIN interface slave task will either subscribe to data or publish data in response. Each time the slave task subscribes to data in response, it will combine the header and response into a single full frame type which is placed into the read queue. If self-reception is enabled, then each time the slave task publishes data in response, it will combine the header and response into a single full frame type which is placed into the read queue. If log bus errors is enabled, then the first bus error that occurs within the header or response portion of each LIN frame will be placed into a bus error frame and loaded into the read queue. The LIN interface slave task will ignore the remainder of the frame transaction on the bus and prepare for the reception of the next header. The loading of the full or bus error frame into the read queue will set a read available flag in the interface. `ncWaitForState` should be used to wait for read available before executing the `ncRead` or `ncReadMult` function. You may choose to insert a time delay after processing one complete frame. The LDF will specify the delay for each ID.

Typically, data that is published by a slave task (including the slave task in a master node, as is the case in this example), is updated as a result of a change in one or more inputs. Response entries within the LIN interface slave task response queue may be updated at any point to emulate this behavior. Steps 4 and 5 should be repeated as necessary to create the desired master behavior.

6. Stop communication.

Stop communication on the LIN bus before closing the Network Interface Object.

7. Close the Network Interface Object.

When you are finished accessing the LIN bus, close the Network Interface Object using the `ncCloseObject` function before you exit the application.

## LIN Interface as Slave Device

The following steps demonstrate how to use the Frame API functions in a LIN application in which the LIN interface is acting as a slave device. The steps are shown in the Figure 9-4, *Frame API – LIN interface acting as slave*.



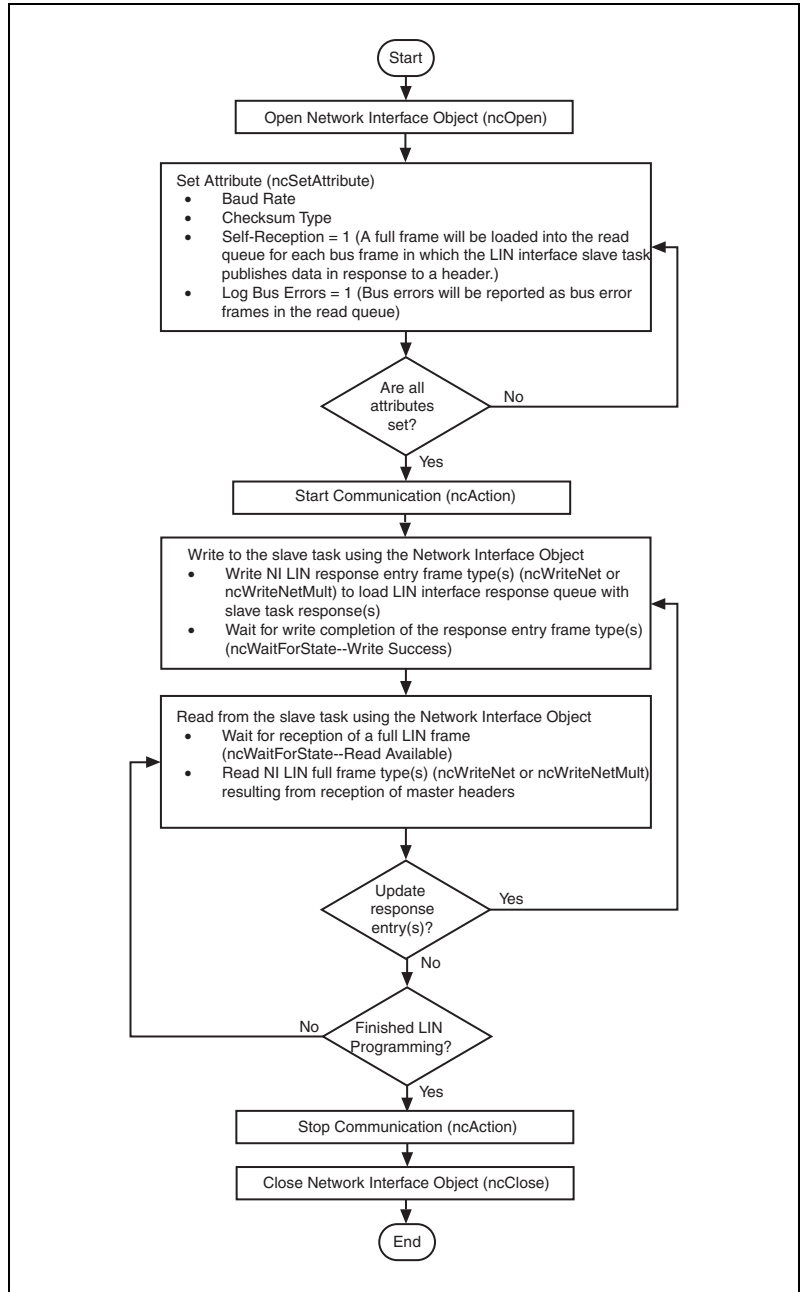

**Figure 9-4.** Frame API – LIN interface acting as slave

1. Open a Network Interface Object

You must call the `ncOpenObject` function to open the Network Interface Object used in this example.

The `ncOpenObject` function returns a handle for use in all subsequent Frame API calls for that object. When you are using the LabVIEW function library, this handle is passed through the upper left and right terminals of each Frame API function used after the open.

2. Set attributes for the Network Interface Object.

Prior to starting the Network Interface Object, you must configure it with its initial attribute settings. These are configured by calling the `ncSetAttribute` function with each desired attribute ID and value. This function takes the name of the object to configure, along with the attribute ID and value.

For this example, the baud rate and checksum type should be configured to match those of the LIN being accessed. Self-reception is shown as enabled but it is optional. When the slave task publishes data, the resulting full frame is logged into the read queue only if self-reception is enabled. In other words, if the response queue is loaded with three entries that publish in response and two entries that subscribe in response, then only the resulting full frames for the IDs of the two subscribing entries will be logged, if self-reception is disabled. If self-reception is enabled, then the resulting full frames for the IDs of all five entries will be logged. Logging of bus errors is useful for troubleshooting, in the event the slave device does not behave as expected.

3. Start Communication.

You must start communication on the LIN bus before you can use the Network Interface Object to transfer data.

4. Write to the slave task using the Network Interface Object.

Write response entry frames to the LIN interface slave task in order to configure how it will respond to the ID in each header received by the master. If it should subscribe to data in response to a header ID, then the DLC should be set to 0 and the data bytes are don't care. If it should publish in response to a header ID, then the DLC should be in the range of one to eight with the data bytes containing the actual data to publish. Write completion of the response entry frame types will set a write success flag in the interface. `ncWaitForState` should be used to wait for write success following the write.

### 5. Read from the slave task using the Network Interface Object

As the external master issues headers, the LIN interface slave task will either subscribe to data or publish data in response to each. Each time the slave task subscribes to data in response, it will combine the header and response into a single full frame type which is placed into the read queue. If self-reception is enabled, then each time the slave task publishes data in response, it will combine the header and response into a single full frame type which is placed into the read queue. If log bus errors is enabled, then the first bus error that occurs within the header or response portion of each LIN frame will be placed into a bus error frame and loaded into the read queue. The LIN interface slave task will ignore the remainder of the frame transaction on the bus and prepare for the reception of the next header. The loading of the full or bus error frame into the read queue will set a read available flag in the interface. `ncWaitForState` should be used to wait for read available before executing the `ncRead` or `ncReadMult` function.

Typically, slave devices that publish data update it as a result of a change in one or more inputs. Response entries within the LIN interface slave task response queue may be updated at any point to emulate this behavior. Steps 4 and 5 should be repeated as necessary to create the desired slave behavior.

### 6. Stop communication.

Stop communication on the LIN bus before closing the Network Interface Object.

### 7. Close the Network Interface Object.

When you are finished accessing the LIN bus, close the Network Interface Object using the `ncCloseObject` function before you exit the application.

## LIN Interface Accesses Single Subscribing Slave Device

The following steps demonstrate how to use the Frame API functions in a LIN application in which the LIN interface is to provide simple access to a single slave device that subscribes to data. The steps are shown in Figure 9-5, *Frame API – LIN interface provides simple access to a single slave device that subscribes to data*.

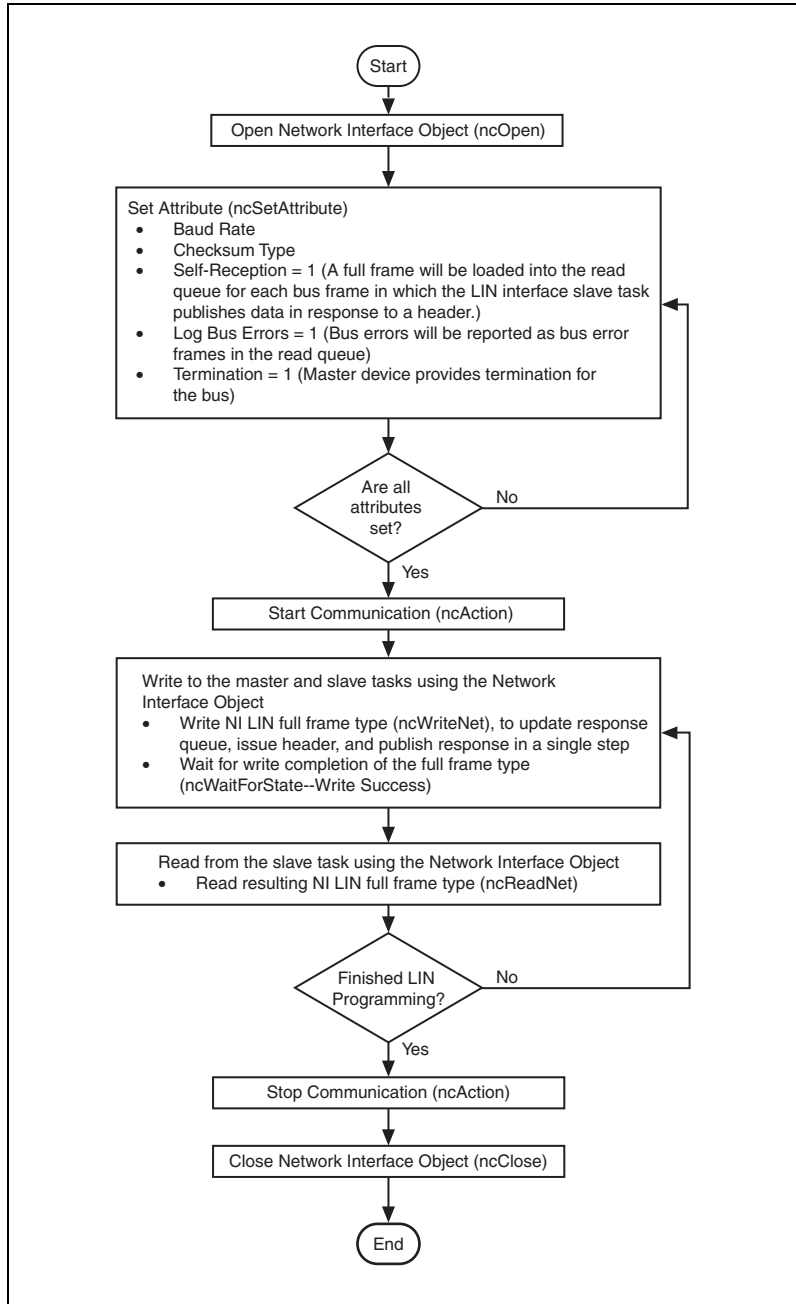

**Figure 9-5.** Frame API – LIN interface provides simple access to a single slave device that subscribes to data

1. Open a Network Interface Object.

You must call the `ncOpenObject` function to open the Network Interface Object used in this example.

The `ncOpenObject` function returns a handle for use in all subsequent Frame API calls for that object. When you are using the LabVIEW function library, this handle is passed through the upper left and right terminals of each Frame API function used after the open.

2. Set attributes for the Network Interface Object.

Prior to starting the Network Interface Object, you must configure it with its initial attribute settings. These are configured by calling the `ncSetAttribute` function with each desired attribute ID and value. This function takes the name of the object to configure, along with the attribute ID and value.

For this example, the baud rate and checksum type should be configured to match those of the slave device. Self-reception is shown as enabled but it is optional. In this example the NI LIN interface slave task is publishing data in response to a master task header. When the slave task publishes data, the resulting full frame is logged into the read queue only if self-reception is enabled. Logging of bus errors is useful for troubleshooting, in the event the slave device does not behave as expected.

3. Start Communication.

You must start communication on the LIN bus before you can use the Network Interface Object to transfer data.

4. Write to the master and slave tasks using the Network Interface Object

Writing a full frame type containing the ID of the slave device to the LIN interface combines three tasks into a single step. First, the LIN interface slave task response queue is updated with the ID and data transferred in the full frame, and the response type is set to publish. Second, the LIN interface master task transmits a header containing the ID onto the bus.

Finally, the LIN interface slave task publishes the data in response to the header (because its response queue has been updated to publish data in response to a header containing this ID). The net effect is that the LIN interface writes data to the slave device (the LIN interface slave task publishes data in response to the header ID while the slave device subscribes to data in response to the header ID). Write completion of the full frame type will set a write success flag in the interface. `ncWaitForState` should be used to wait for write success following the write.

5. Read from the slave task using the Network Interface Object.

If the slave device is working as expected, it will subscribe to data in response to the header transmitted in step 4. The NI LIN interface slave task will publish data in response and, if self-reception is enabled, combine the header and response data into a full frame type to be logged in the read queue. If the slave device is not working as expected (perhaps it publishes in response to the header, in which case there is a collision on the LIN), the resulting bus error frame will be placed into the read queue, since logging of bus errors has been enabled. Steps 4 and 5 should be repeated for each data set you want to write to the slave device.

6. Stop communication.

Stop communication on the LIN bus before closing the Network Interface Object.

7. Close the Network Interface Object.

When you are finished accessing the LIN bus, close the Network Interface Object using the `ncCloseObject` function before you exit the application.

## LIN Interface Accesses Single Publishing Slave Device

The following steps demonstrate how to use the Frame API functions in a LIN application in which the LIN interface is to provide simple access to a single slave device that publishes data. The steps are shown in Figure 9-6, *Frame API – LIN interface provides simple access to a single slave device that publishes data*.

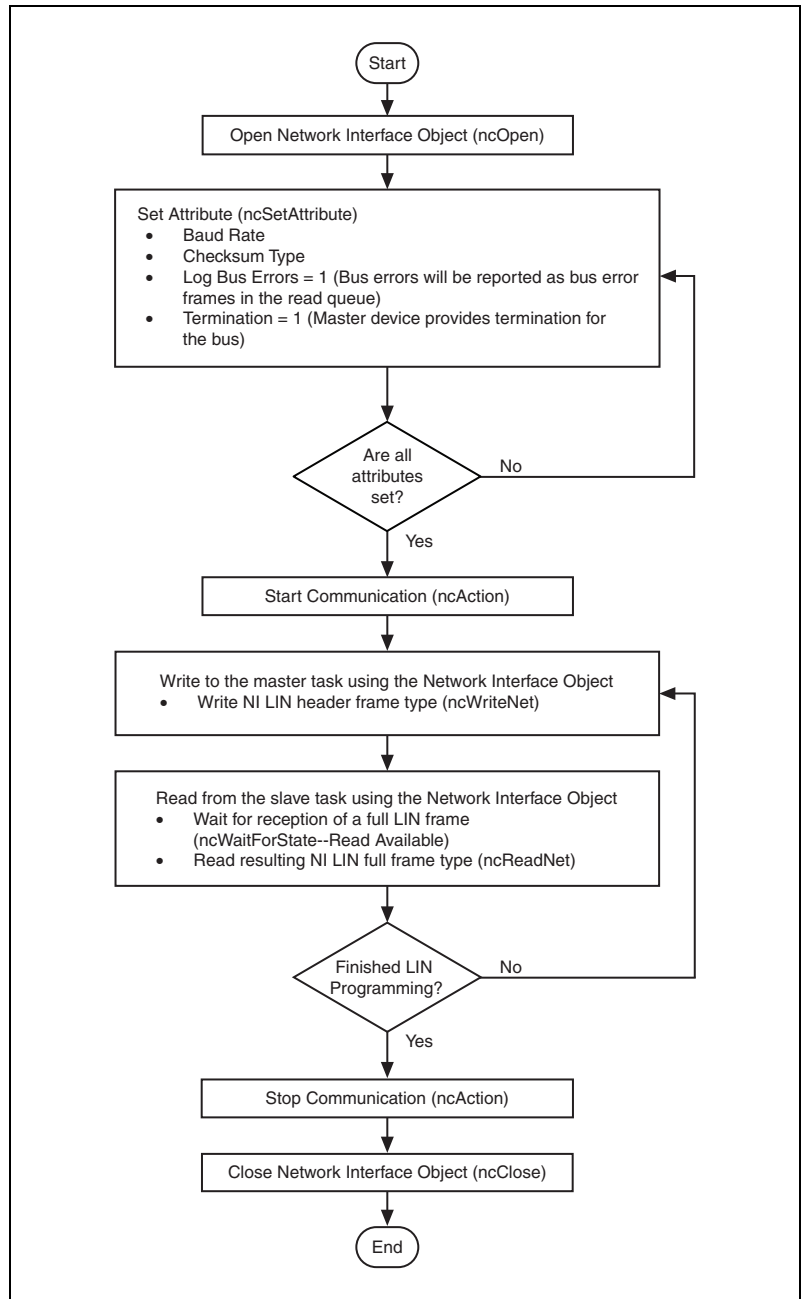

**Figure 9-6.** Frame API – LIN interface provides simple access to a single slave device that publishes data

1. Open a Network Interface Object.

You must call the `ncOpenObject` function to open the Network Interface Object used in this example.

The `ncOpenObject` function returns a handle for use in all subsequent Frame API calls for that object. When you are using the LabVIEW function library, this handle is passed through the upper left and right terminals of each Frame API function used after the open.

2. Set attributes for the Network Interface Object.

Prior to starting the Network Interface Object, you must configure it with its initial attribute settings. These are configured by calling the `ncSetAttribute` function with each desired attribute ID and value. This function takes the name of the object to configure, along with the attribute ID and value.

For this example, the baud rate and checksum type should be configured to match those of the slave device. Logging of bus errors is useful for troubleshooting, in the event the device does not behave as expected.

3. Start Communication.

You must start communication on the LIN bus before you can use the Network Interface Object to transfer data.

4. Write to the master task using the Network Interface Object.

Writing a header frame type containing the ID of the slave device to the LIN interface causes a break-sync-id sequence to be transmitted on the LIN.

5. Read from the slave task using the Network Interface Object.

If the slave device is working as expected, it will publish data in response to the header transmitted in step 4. The NI LIN interface slave task will subscribe to this data by default and consequently log it and the header as a full frame type in the read queue. If the slave device is not working as expected, the resulting bus error frame will be placed into the read queue, since logging of bus errors has been enabled. The loading of the full or bus error frame into the read queue will set a read available flag in the interface. `ncWaitForState` should be used to wait for read available before executing the `ncRead` or `ncReadMult` function. Steps 4 and 5 should be repeated for each data set you want to read from the slave device.



6. Stop communication.

Stop communication on the LIN bus before closing the Network Interface Object.

7. Close the Network Interface Object.

When you are finished accessing the LIN bus, close the Network Interface Object using the `ncCloseObject` function before you exit the application.

## LIN Interface Sleep and Wakeup Behavior

Regardless of whether the LIN interface is acting as a master or slave device, a bus inactive frame will always be loaded into the read queue after four seconds of bus inactivity. An external device may also request that the bus go to sleep, which the LIN interface will return as a full frame containing the sleep request message. The NI-CAN Frame API for LIN provides the option of ignoring the bus inactive frame or sleep request, or placing the interface into sleep mode by setting the sleep attribute to true. Keep in mind that if the bus inactive frame or sleep request is ignored and the other devices on the bus go to sleep, then the interface will ignore all bus activity (wakeup breaks) until a valid break-sync sequence is received. This behavior may be desirable in instances where you simply want to log complete frames transmitted over the bus or act as a slave device. If the interface is placed into sleep mode upon receiving the bus inactive frame or sleep request, it may either wake or be awakened by, the bus.

Figure 9-7, *Frame API – LIN interface sleep and wakeup behavior*, shows how to implement sleep and wakeup behavior when the interface is acting as either a master or slave device. The flowchart assumes that an interface has been opened, the desired attribute values have been initialized, it has been started, and `ncWaitForState` (to check for read available) combined with `ncReadNet` or `ncReadNetMult`, are being used to read frames from the bus.

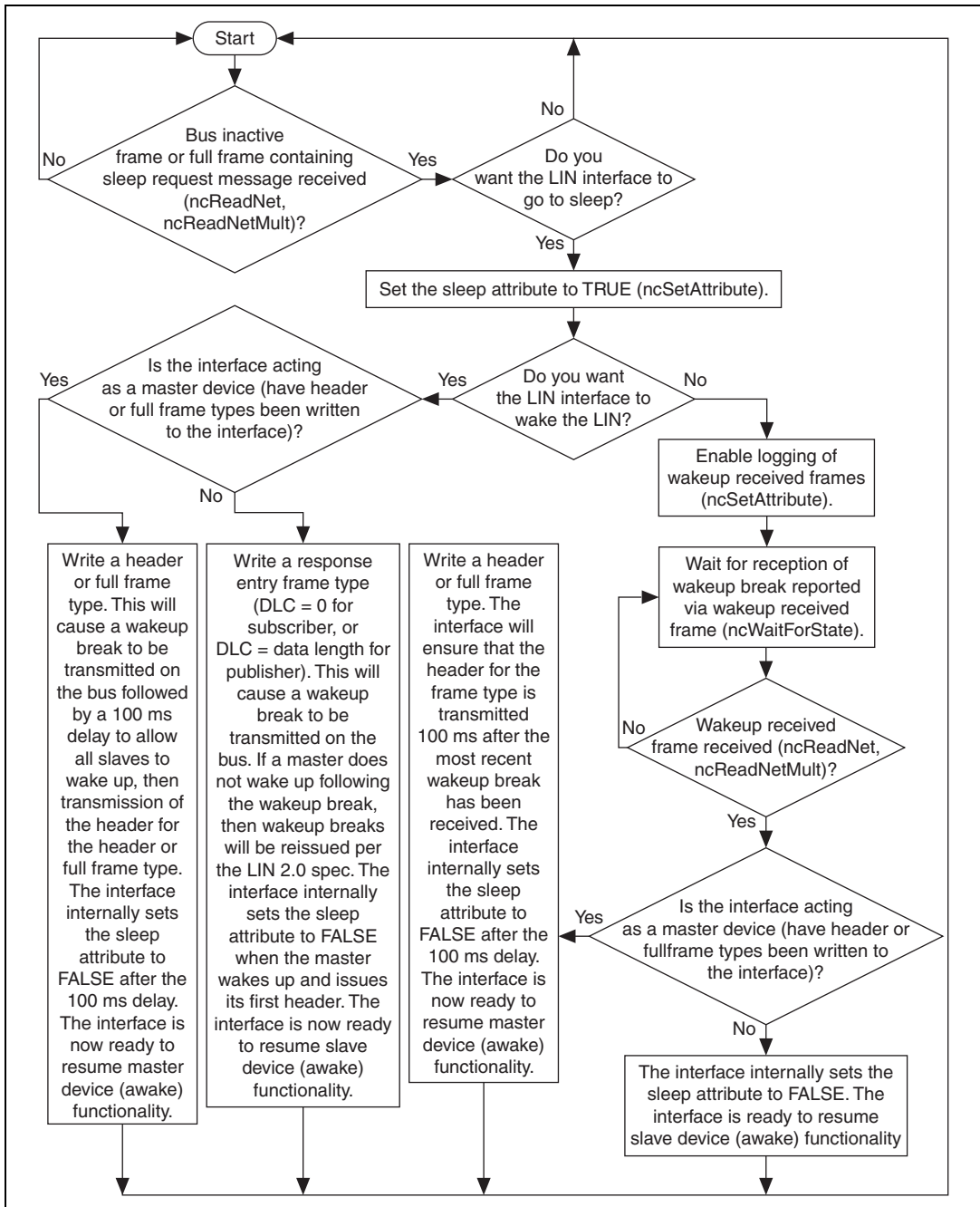

Figure 9-7. Frame API – LIN interface sleep and wakeup behavior

# Frame API Additional Programming Topics

---

The following sections include information you can use to extend the basic programming model.

## RTSI

The Frame API provides RTSI features that are lower level than the synchronization features of the Channel API. The following list describes some of the more commonly used RTSI features in the Frame API.

- You can configure the CAN Network Interface Object to log a special RTSI frame into the read queue when a RTSI input transitions from low to high. This RTSI frame is timestamped, so you can use it to analyze the time of the RTSI pulse relative to the CAN frames on the network.
- You can configure the CAN Object to generate a RTSI output pulse when its ID is received. This allows you to trigger other products based on the reception of a specific CAN frame.
- You can configure the CAN Object to transmit a CAN frame when a RTSI input transitions from low to high. This allows you to transmit based on a functional unit in another product, such as a counter in an NI-DAQ or NI-DAQmx E Series MIO product.
- You can use `ncConnectTerminals` and the **Timestamp Format** attribute to synchronize multiple CAN cards by connecting timebases and start triggers. The `ncConnectTerminals` function provides additional RTSI features that can be used in conjunction with the object-based RTSI features described above.

For more information on RTSI configuration, refer to the `ncConfig` and `ncConnectTerminals` functions in this manual.

## Remote Frames

The Frame API has extensive features to transmit and receive remote frames. The following list describes some of the more commonly used remote frame features in the Frame API.

- The CAN Network Interface Object can transmit arbitrary remote frames.
- If you are using Series 2 hardware or later, the CAN Network Interface Object can receive remote frames, such as to monitor bus traffic. Series 1 hardware uses the Intel 82527 CAN controller, which cannot receive arbitrary remote frames.

- You can configure a CAN Object to transmit a remote frame and receive the corresponding data frame. The remote frame can be transmitted periodically, based on a RTSI input, or each time you call `ncWrite`.
- You can configure a CAN Object to transmit a data frame in response to reception of the corresponding remote frame.

## Using Queues

To maintain an ordered history of data transfers, NI-CAN supports the use of queues, also known as FIFO (first-in-first-out) buffers. The basic behavior of such queues is common to all NI-CAN objects.

There are two basic types of NI-CAN queues: the read queue and the write queue. NI-CAN uses the read queue to store incoming network data items in the order they arrive. You access the read queue using `ncRead` to obtain the data. NI-CAN uses the write queue to transmit network frames one at a time using the network interface hardware. You access the write queue using `ncWrite` to store network data items for transmission.

## State Transitions

The `NC_ST_READ_AVAIL` state transitions from false to true when NI-CAN places a new data item into an empty read queue, and remains true until you read the last data item from the queue and the queue is empty.

The `NC_ST_READ_MULT` state transitions from false to true when the number of items in a queue exceeds a threshold. The threshold is set using the `NC_ATTR_NOTIFY_MULT_LEN` attribute. The `NC_ST_READ_MULT` state and `ncReadMult` function are useful in high-traffic networks in which data items arrive quickly.

The `NC_ST_WRITE_SUCCESS` state transitions from false to true when the write queue is empty and NI-CAN has successfully transmitted the last data item onto the network. The `NC_ST_WRITE_SUCCESS` state remains true until you write another data item into the write queue. When communication starts, the `NC_ST_WRITE_SUCCESS` state is true by default.

## Empty Queues

For both read and write queues, the behavior for reading an empty queue is similar. When you read an empty queue, the previous data item is returned again. For example, if you call `ncRead` when `NC_ST_READ_AVAIL` is false, the data from the previous call to `ncRead` is returned again, along with the

CanWarnOldData warning. If no data item has yet arrived for the read queue, a default data item is returned, which consists of all zeros. You should generally wait for `NC_ST_READ_AVAIL` prior to the first call to `ncRead`.

## Full Queues

For both read and write queues, the behavior for writing a full queue is similar. When you write a full queue, NI-CAN returns the `CanErrOverflowWrite` error code. For example, if you write too many data items to a write queue, the `ncWrite` function eventually returns the overflow error.

## Disabling Queues

If you do not need a complete history of all data items, you can disable the read queue and/or write queue by setting its length to zero. Zero length queues are typically used only with CAN objects, not the CAN Network Interface Object. Using zero length queues generally saves memory, and often results in better performance. When a new data item arrives for a zero length queue, it overwrites the previous item without indicating an overflow. The `NC_ST_READ_AVAIL` and `NC_ST_WRITE_SUCCESS` states still behave as usual, but you can ignore them if you want only the most recent data. For example, when NI-CAN writes a new data item to the read buffer, the `NC_ST_READ_AVAIL` state becomes true until the data item is read. If you only want the most recent data, you can ignore the `NC_ST_READ_AVAIL` state, as well as the `CanWarnOldData` warning returned by `ncRead`.

## Using the CAN Network Interface Object with CAN Objects

For many applications, it is desirable to use a CAN Network Interface Object in conjunction with higher level CAN Objects. For example, you can use CAN objects to transmit data or remote frames periodically, and use the CAN Network Interface Object to receive all incoming frames.

When one or more CAN Objects are open, the CAN Network Interface Object cannot receive frames which would normally be handled by the CAN Objects. The following flowchart shows the steps performed by the Frame API when a CAN frame is received.

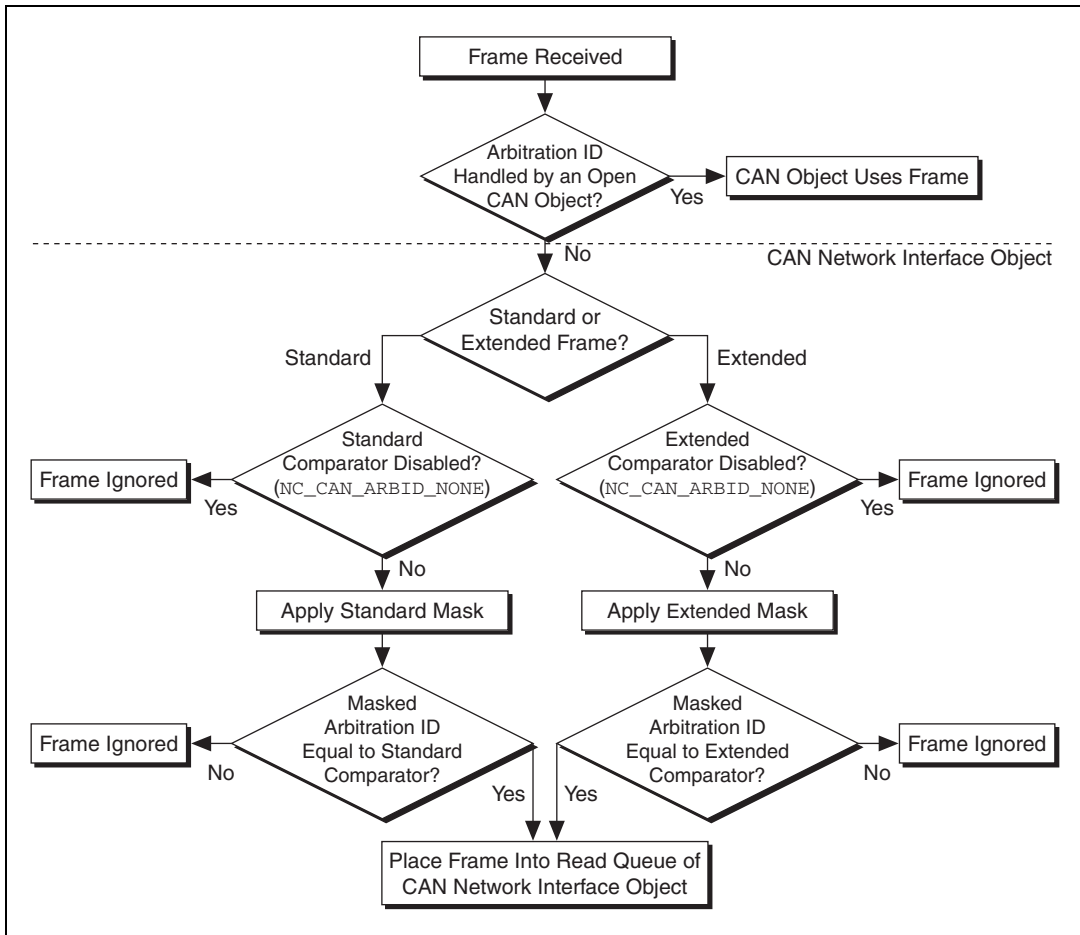

**Figure 9-8.** Flowchart for CAN Frame Reception

The decisions outlined in Figure 9-8 are generally performed by the onboard CAN communications controller chip. Nevertheless, if you intend to use CAN Objects as the sole means of accessing the CAN bus, it is best to disable all frame reception in the CAN Network Interface Object by setting the comparator attributes to `NC_CAN_ARBID_NONE` (hex `CFFFFFFF`). By doing this, the CAN communications controller chip is best able to filter out all incoming frames except those handled by CAN Objects.

## Detecting State Changes

You can detect state changes for an object using one of the following schemes:

- Call `ncWaitForState` to wait for one or more states to occur.
- Use `ncCreateNotification` in C/C++ to register a callback for one or more states.
- Use `ncCreateOccurrence` in LabVIEW to create an occurrence for one or more states. The `ncCreateOccurrence` function is not supported by the 847x and 847x with Sync series CAN and LIN interfaces.
- Call `ncGetAttribute` to get the `NC_ATTR_STATE` attribute.

Use the `ncWaitForState` function when the application must wait for a specific state before proceeding. For example, if you call `ncWrite` to write a frame, and the application cannot proceed until the frame is successfully transmitted, you can call `ncWaitForState` to wait for `NC_ST_WRITE_SUCCESS`.

Use the `ncCreateNotification` function in C/C++ when the application must handle a specific state, but can perform other processing while waiting for that state to occur. The `ncCreateNotification` function registers a callback function, which is invoked when the desired state occurs. For example, a callback function for `NC_ST_READ_AVAIL` can call `ncRead` and place the resulting data in a buffer. The application can then perform any tasks desired, and process the CAN data only as needed.

Use the `ncCreateOccurrence` function in LabVIEW when the application must handle a specific state, but can perform other processing while waiting for that state to occur. The `ncCreateOccurrence` function creates a LabVIEW occurrence, which is set when the desired state occurs. Occurrences are the mechanism used in LabVIEW to provide multithreaded execution.

Use the `ncGetAttribute` function when you need to determine the current state of an object.

## Frame to Channel Conversion

Many applications require the ability to convert CAN data between a CAN frame and a CAN channel. For information on frame to channel conversion, channel to frame conversion, and virtual interfaces, refer to the [Frame to Channel Conversion](#) section of Chapter 6, *Using the Channel API*.

## Differences between CAN and LIN

When transitioning from CAN to LIN programming, it is helpful to note some differences between the two networks. Unlike CAN, there is no prioritization of LIN frames based on ID. Since LIN is a polled bus with the master initiating all frame transfers, there is no need for frame prioritization. Also unlike CAN, the number of data bytes in a LIN frame may not be zero, but is limited to the range of one to eight bytes. A LIN frame contains neither a data length code nor an end-of-frame delimiter. This means that when a slave task is receiving response data, it has either been configured with the number of bytes expected to be received for the current ID, or has no knowledge of how many bytes it will receive, which means it must use frame slot timeout or reception of next break to determine end-of-current-frame. Although CAN may operate somewhat similarly to a polled bus when using remote frames, its normal operational behavior does not fit that mode.

There is no concept of master and slave in CAN. Any device may transmit data or remote frames at any time. Collisions are acceptable and resolved by ID prioritization. When a data or remote frame is transmitted, the full frame is transmitted by the sender. In contrast, a single LIN master task is responsible for initiating all frame transfers. The master task only sends the first part of the frame (the header) with the expectation that a slave task will complete the frame (by publishing a response). CAN provides advanced mechanisms for reporting multiple errors within a single frame, incrementing or decrementing error counters, and entering various error states (bus off, for example). In contrast, LIN error handling is a single-shot process. Upon encountering the first error in a frame, the LIN slave device reports the error, ignores the remainder of the frame, and prepares for reception of the next header from the master task.



---

## Frame API for LabVIEW

This chapter lists the LabVIEW VIs for the NI-CAN Frame API and describes the format, purpose, and parameters for each VI. The VIs in this chapter are listed alphabetically.

Unless otherwise stated, each NI-CAN VI suspends execution of the calling thread until it completes.

### Section Headings

---

The following are section headings found in the Frame API for LabVIEW VIs.

#### **Purpose**

Each VI description includes a brief statement of the purpose of the VI.

#### **Format**

The format section describes the format of each VI.

#### **Input and Output**

The input and output parameters for each VI are listed.

#### **Description**

The description section gives details about the purpose and effect of each VI.

#### **Network Interface Object**

The Network Interface Object section gives details about using the VI with the Network Interface Object.

#### **CAN Object**

The CAN Object section gives details about using the VI with the CAN Object.

## List of VIs

Table 10-1 is an alphabetical list of the NI-CAN VIs for the Frame API.

**Table 10-1.** Frame API for LabVIEW VIs

<b>Function</b>	<b>Purpose</b>
<b>ncAction.vi</b>	Perform an action on an object.
<b>ncClose.vi</b>	Close an object.
<b>ncConfigCANNet.vi</b>	Configure a CAN Network Interface Object before opening it.
<b>ncConfigCANNetRTSI.vi</b>	Configure a CAN Network Interface Object with RTSI features.
<b>ncConfigCANObj.vi</b>	Configure a CAN Object before using it.
<b>ncConfigCANObjRTSI.vi</b>	Configure a CAN Object with RTSI features.
<b>ncConnectTerminals.vi</b>	Connect terminals in the CAN or LIN hardware.
<b>ncDisconnectTerminals.vi</b>	Disconnect terminals in the CAN or LIN hardware.
<b>ncGetAttr.vi</b>	Get the value of an object attribute.
<b>ncGetHardwareInfo.vi</b>	Get NI-CAN hardware information.
<b>ncGetTimer.vi</b>	Get the absolute timestamp attribute.
<b>ncOpen.vi</b>	Open an object.
<b>ncReadNet.vi</b>	Read single frame from a CAN or LIN Network Interface Object.
<b>ncReadNetMult.vi</b>	Read multiple frames from a CAN or LIN Network Interface Object.
<b>ncReadObj.vi</b>	Read single frame from a CAN Object.
<b>ncReadObjMult.vi</b>	Read multiple frames from a CAN Object.
<b>ncSetAttr.vi</b>	Set the value of an object attribute.
<b>ncWaitForState.vi</b>	Wait for one or more states to occur in an object.
<b>ncWriteNet.vi</b>	Write a single frame to a CAN or LIN Network Interface Object.

**Table 10-1.** Frame API for LabVIEW VIs (Continued)

<b>Function</b>	<b>Purpose</b>
<a href="#">ncWriteNetMult.vi</a>	Write multiple frames to a CAN or LIN Network Interface Object.
<a href="#">ncWriteObj.vi</a>	Write a single frame to a CAN Object.

## ncAction.vi

---

### Purpose

Perform an action on an object.

### Format

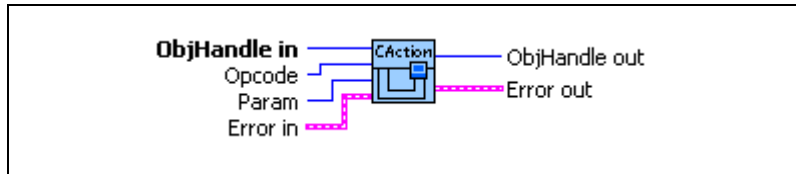

### Input



**ObjHandle in** is the object handle from the previous NI-CAN VI. The handle originates from **ncOpen.vi**.



**Opcode** is the operation code indicating which action to perform. Refer to Table 10-2, *Actions Supported By A CAN or LIN Network Interface Object*, and Table 10-3, *Actions Supported By A CAN Object*.



**Param** is an optional parameter whose meaning is defined by **Opcode**.



**Error in** describes error conditions occurring before the VI executes. If an error has already occurred, the VI returns the value of the **Error in** cluster in **Error out**.



**status** is True if an error occurred. If **status** is True, the VI does not perform any operations.



**code** is the error code number identifying an error. A value of 0 means success. A negative value means error: VI did not execute the intended operation. A positive value means warning: VI executed intended operation, but an informational warning is returned. For a description of the **code**, wire the error cluster to a LabVIEW error-handling VI, such as the Simple Error Handler.



**source** identifies the VI where the error occurred.

## Output



**ObjHandle out** is the object handle for the next NI-CAN VI.

**Error out** describes error conditions. If the **Error in** cluster indicated an error, the **Error out** cluster contains the same information. Otherwise, **Error out** describes the error status of this VI.



**status** is True if an error occurred.

**code** is the error code number identifying an error. A value of 0 means success. A negative value means error: VI did not execute the intended operation. A positive value means warning: VI executed intended operation, but an informational warning is returned. For a description of the **code**, wire the error cluster to a LabVIEW error-handling VI, such as the Simple Error Handler.



**source** identifies the VI where the error occurred.

## Description

**ncAction.vi** is a general purpose VI you can use to perform an action on the object specified by **ObjHandle in**. Its normal use is to start and stop network communication on a CAN Network Interface Object.

NI-CAN provides VIs such as **ncOpen.vi** and **ncReadNet.vi** for the most frequently used and/or complex actions. **ncAction.vi** provides an easy, general purpose way to perform actions that are used less frequently or are relatively simple.

## Network Interface Object

NI-CAN propagates all actions on the CAN Network Interface Object up to all open Objects when CAN Objects are supported.

Table 10-2, *Actions Supported By A CAN or LIN Network Interface Object*, describes the actions supported by the CAN or LIN Network Interface Object.

**Table 10-2.** Actions Supported By A CAN or LIN Network Interface Object

Opcode	Param	Description
Start	N/A (ignored)	Transitions network interface from stopped (idle) state to started (running) state. If network interface is already started, this operation has no effect. When a network interface is started, it is communicating on the network. When you execute the Start action on a stopped CAN Network Interface Object, NI-CAN propagates it upward to all open higher-level CAN Objects. Thus, you can use it to start all higher-level network communication simultaneously.
Stop	N/A (ignored)	Transitions network interface from started state to stopped state. If network interface is already stopped, this operation has no effect. When a network interface is stopped, it is not communicating on the network. The Stop action clears all entries from the read queue of the Network Interface. When you execute the Stop action on a running CAN Network Interface Object, NI-CAN propagates it upward to all open higher-level CAN Objects.
Reset	N/A (ignored)	Resets network interface. The Reset action first issues the Stop action, then clears all entries from the write queue, then resets the CAN or LIN hardware. Resetting the CAN hardware sets the CAN error counters to zero, returning the CAN controller to error active state. Resetting the LIN hardware returns the interface to slave mode and resets all slave task response queue entries so that the slave task subscribes to all LIN IDs. The reset action is propagated up to all open higher-level CAN Objects.
Output on RTSI line	N/A (ignored)	Output a pulse or toggle on the RTSI line depending upon the <b>RTSI Behavior</b> attribute. The <b>Output on RTSI line</b> action is not supported on the 847x or 847x with Sync series hardware.

## CAN Object

All actions performed on a CAN Object affect that CAN Object alone, and do not affect other CAN Objects or communication as a whole. Table 10-3, *Actions Supported By A CAN Object*, describes the actions supported by the CAN Object.

**Table 10-3.** Actions Supported By A CAN Object

Opcode	Param	Description
Start	N/A (ignored)	Transitions the CAN object from stopped (idle) state to started (running) state. If the CAN object is already started, this operation has no effect.
Stop	N/A (ignored)	Stops the CAN Object. For example, if the CAN Object is configured to transmit data frames periodically, this action stops the periodic transmissions. This action will also clear all entries from the read queue.
Reset	N/A (ignored)	Resets the CAN Object. Stops the CAN Object, then clears all entries from read and write queues.
Output on RTSI line	N/A (ignored)	Output a pulse or toggle on the RTSI line depending upon the <b>RTSI Behavior</b> attribute.

## ncClose.vi

---

### Purpose

Close an object.

### Format

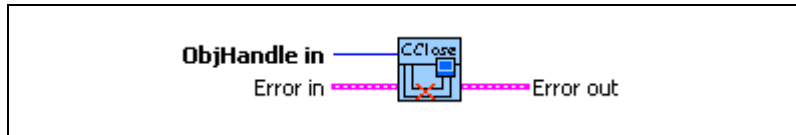

### Input



**ObjHandle in** is the object handle from the previous NI-CAN VI. The handle originates from **ncOpen.vi**.



**Error in** describes error conditions occurring before the VI executes. If an error has already occurred, the VI returns the value of the **Error in** cluster in **Error out**.



**status** is True if an error occurred. Unlike other NI-CAN VIs, this VI always closes the object, regardless of the value of **status**.



**code** is the error code number identifying an error. A value of 0 means success. A negative value means error: VI did not execute the intended operation. A positive value means warning: VI executed intended operation, but an informational warning is returned. For a description of the **code**, wire the error cluster to a LabVIEW error-handling VI, such as the Simple Error Handler.



**source** identifies the VI where the error occurred.

### Output



**Error out** describes error conditions. If the **Error in** cluster indicated an error, the **Error out** cluster contains the same information. Otherwise, **Error out** describes the error status of this VI.



**status** is True if an error occurred.



**code** is the error code number identifying an error. A value of 0 means success. A negative value means error: VI did not execute the intended operation. A positive value means warning: VI executed intended operation, but an informational warning is



returned. For a description of the **code**, wire the error cluster to a LabVIEW error-handling VI, such as the Simple Error Handler.



**source** identifies the VI where the error occurred.

## Description

**ncClose.vi** closes an object when it no longer needs to be in use, such as when the application is about to exit. When an object is closed, NI-CAN stops all pending operations and clears all configuration for the object (including RTSI). The application can no longer use that specific **ObjHandle in**.

Unlike other NI-CAN VIs, this VI always closes the object, regardless of the **Status in Error In**.

## Network Interface Object

**ObjHandle in** refers to an open CAN or LIN Network Interface Object.

## CAN Object

**ObjHandle in** refers to an open CAN Object.

## ncConfigCANNet.vi

### Purpose

Configure a CAN Network Interface Object before opening it.

### Format



### Input



**ObjName** is the name of the CAN Network Interface Object to configure. This name uses the syntax “CAN $x$ ”, where  $x$  is a decimal number starting at zero that indicates the CAN network interface (CAN0, CAN1, up to CAN63). CAN network interface names are associated with physical CAN ports using the Measurement and Automation Explorer (MAX).

The Frame API and Channel API cannot use the same CAN network interface simultaneously. If the CAN network interface is already initialized in the Channel API, this function returns an error.

The special interface values 256 and 257 refer to virtual interfaces. For virtual interfaces, the only valid attribute is **Start On Open**. All other attributes in the config cluster are ignored. The mask and comparator attributes are always zero for virtual interfaces (receive all frames).

For more information on usage of virtual interfaces, refer to the [Frame to Channel Conversion](#) section of Chapter 6, [Using the Channel API](#).

The 847 $x$  and 847 $x$  with Sync series LIN interfaces do not support **ncConfigCANNet.vi**.



**CAN Network Interface Config** provides the core configuration attributes of the CAN Network Interface Object. This cluster uses the typedef **ncNetAttr.ctl**. You can wire in the cluster by first placing it on the front panel from the NI-CAN Controls palette, or you can right-click the VI input and select **Create Constant** or **Create Control**.

For the 847 $x$  and 847 $x$  with Sync series CAN interfaces, only **Start on Open** and **Baud Rate** are valid configuration attributes. All other configuration attributes are ignored.

U32

**Start On Open** indicates whether communication starts for the CAN Network Interface Object (and all applicable CAN Objects) immediately upon opening the object with **ncOpen.vi**. The default is True, which starts communication when **ncOpen.vi** is called. If you set **Start On Open** to False, you can call **ncSetAttr.vi** after opening the interface, then **ncAction.vi** to start communication. **ncSetAttr.vi** can be used to set attributes that are not contained within **ncConfigCANNet.vi**.

U32

**Baud Rate** is the baud rate to use for communication. Basic baud rates are supported, including 33333, 83333, 100000, 125000, 250000, 500000, and 1000000. If you are familiar with the Bit Timing registers used in CAN controllers, you can use a special hexadecimal baud rate of 0x8000zzyy, where yy is the desired value for register 0 (BTR0), and zz is the desired value for register 1 (BTR1) of the CAN controller.

For the Frame API, the **Baud Rate** has no relationship with the baud rate property in MAX. You must always configure the **Baud Rate** with **ncConfigCANNet.vi**.

U32

**Read Queue Length** is the maximum number of unread frames for the read queue of the CAN Network Interface Object. A typical value is 100. For more information, refer to **ncReadNetMult.vi**.

The internal read queue exists between the CAN hardware and the NI-CAN device driver. This internal read queue holds frames temporarily prior to transfer a larger queue in the NI-CAN device driver. The larger NI-CAN device driver queue grows as needed in order to accommodate high bus loads.

For more information on reading from the CAN Network Interface Object, refer to **ncReadNetMult.vi**.

U32

**Write Queue Length** is the maximum number of frames for the internal write queue of the CAN Network Interface Object awaiting transmission. A typical value is 10.

The internal write queue exists between the CAN hardware and the NI-CAN driver. This internal write queue holds frames temporarily prior to transfer to CAN hardware from a larger queue in the NI-CAN device driver.

For more information on writing to the CAN Network Interface object, refer to **ncWriteNetMult.vi**.



**Standard Comparator** is the CAN arbitration ID for the standard (11-bit) frame comparator. For information on how this attribute is used to filter received frames for the Network Interface, refer to the following **Standard Comparator** attribute.

If you intend to open the Network Interface, most applications can set this attribute and the **Standard Comparator** to 0 in order to receive all standard frames.

If you intend to use CAN Objects as the sole means of receiving standard frames from the network, you should disable all standard frame reception in the Network Interface by setting this attribute to the special value CFFFFFFF hex. With this setting, the Network Interface is best able to filter out incoming standard frames except those handled by CAN Objects.



**Standard Mask** is the bit mask used in conjunction with the **Standard Comparator** attribute for filtration of incoming standard (11-bit) CAN frames. For each bit set in the mask, NI-CAN compares the corresponding bit in the **Standard Comparator** to the arbitration ID of the received frame. If the mask/comparator matches, the frame is stored in the Network Interface queue, otherwise it is discarded. Bits in the mask that are clear are treated as don't-cares. For example, hex 00000700 means to compare only the three upper bits of the 11-bit standard ID.

If you set the **Standard Comparator** to CFFFFFFF hex, this attribute is ignored, because all standard frame reception is disabled for the Network Interface.

Most applications can set this attribute and the **Standard Comparator** to 0 to receive all standard frames. This is particularly advisable for Series 2 hardware, because the Philips SJA1000 CAN controller does not support distinct filters for standard and extended IDs. For Series 2, nonzero values for this attribute are implemented in software, as an additional filter applied after the **Series 2 Filter Mode**. When you set this attribute to zero for Series 2, filtering is optimized to use only the **Series 2 Filter Mode** attribute for the SJA1000.



**Extended Comparator** is the CAN arbitration ID for the extended (29-bit) frame comparator. For information on how this attribute is used to filter extended frames for the Network Interface, refer to the following **Extended Mask** attribute.

If you intend to open the Network Interface, most applications can set this attribute and the Extended Mask to 0 in order to receive all extended frames.

If you intend to use CAN Objects as the sole means of receiving extended frames from the network, you should disable all extended frame reception in the Network Interface by setting this attribute to the special value CFFFFFFF hex. With this setting, the Network Interface is best able to filter out incoming extended frames except those handled by CAN Objects.



**Extended Mask** is the bit mask used in conjunction with the **Extended Comparator** attribute for filtration of incoming extended (29-bit) CAN frames. For each bit set in the mask, NI-CAN compares the corresponding bit in the **Extended Comparator** to the arbitration ID of the received frame. If the mask/comparator matches, the frame is stored in the Network Interface queue, otherwise it is discarded. Bits in the mask that are clear are treated as don't-cares. For example, hex 1F000000 means to compare only the five upper bits of the 29-bit extended ID.

If you set the **Extended Comparator** to CFFFFFFF hex, this attribute is ignored, because all extended frame reception is disabled for the Network Interface.

Most applications can set this attribute and the **Extended Comparator** to 0 to receive all extended frames. This is particularly advisable for Series 2 hardware, because the Philips SJA1000 CAN controller does not support distinct filters for standard and extended IDs. For Series 2, nonzero values for this attribute are implemented in software, as an additional filter applied after the **Series 2 Filter Mode**. When you set this attribute to zero for Series 2, filtering is optimized to use only the **Series 2 Filter Mode** attribute for the SJA1000.



**Error in** describes error conditions occurring before the VI executes. If an error has already occurred, the VI returns the value of the **Error in** cluster in **Error out**.



**status** is True if an error occurred. If **status** is True, the VI does not perform any operations.



**code** is the error code number identifying an error. A value of 0 means success. A negative value means error: VI did not execute the intended operation. A positive value means warning: VI

executed intended operation, but an informational warning is returned. For a description of the **code**, wire the error cluster to a LabVIEW error-handling VI, such as the Simple Error Handler.



**source** identifies the VI where the error occurred.

## Output



**Error out** describes error conditions. If the **Error in** cluster indicated an error, the **Error out** cluster contains the same information. Otherwise, **Error out** describes the error status of this VI.



**status** is True if an error occurred.



**code** is the error code number identifying an error. A value of 0 means success. A negative value means error: VI did not execute the intended operation. A positive value means warning: VI executed intended operation, but an informational warning is returned. For a description of the **code**, wire the error cluster to a LabVIEW error-handling VI, such as the Simple Error Handler.



**source** identifies the VI where the error occurred.

## Description

The Network Interface provides read/write access to all IDs on the network.

If you intend to use RTSI features to synchronize the Network Interface with other National Instruments cards, refer to [ncConfigCANNetRTSI.vi](#).

If you need to log transceiver fault indications to the Network Interface read queue, refer to the **Log Comm Warnings** attribute of [ncSetAttr.vi](#)

The first NI-CAN VI in the application will normally be [ncConfigCANNet.vi](#).

For the 847x and 847x with Sync series CAN interfaces, only **Start On Open** and **Baud Rate** are valid configuration attributes.

The 847x and 847x with Sync series LIN interfaces do not support [ncConfigCANNet.vi](#).

## ncConfigCANNetRTSI.vi

### Purpose

Configure a CAN Network Interface Object with RTSI features.

### Format

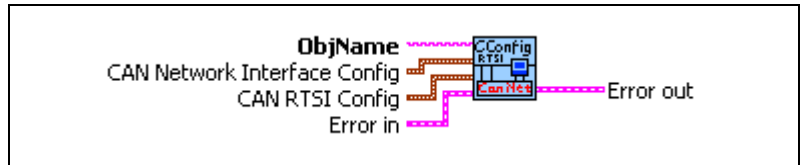

### Input



**ObjName** is the name of the CAN Network Interface Object to configure. This name uses the syntax “CAN $x$ ”, where  $x$  is a decimal number starting at zero that indicates the CAN network interface (CAN0, CAN1, up to CAN63). CAN network interface names are associated with physical CAN ports using the Measurement and Automation Explorer (MAX).

The 847 $x$  and 847 $x$  with Sync series CAN and LIN interfaces do not support **ncConfigCANNetRTSI.vi**.



**CAN Network Interface Config** provides the core configuration attributes of the CAN Network Interface Object. This cluster uses the typedef **ncNetAttr.ctl**. You can wire in the cluster by first placing it on the front panel from the NI-CAN Controls palette, or you can right-click the VI input and select **Create Constant** or **Create Control**. (For more information, refer to [ncConfigCANNet.vi](#).)



**CAN RTSI Config** provides RTSI configuration attributes for the CAN Network Interface Object. This cluster uses the typedef **ncCANRtsiAttr.ctl**. You can wire in the cluster by first placing it on the front panel from the NI-CAN Controls palette, or you can right-click the VI input and select **Create Constant** or **Create Control**.



**RTSI Mode** specifies the behavior of the Network Interface with respect to RTSI, including whether the RTSI signal is an input or output.

### Disable RTSI

Disables RTSI behavior for the Network Interface. All other RTSI attributes are ignored. Using this mode is equivalent to calling [ncConfigCANNet.vi](#).

### On RTSI Input - Transmit CAN Frame

The Network Interface will transmit a frame from its write queue when the RTSI input transitions from low to high. To begin transmission, at least one data frame must be written using [ncWriteNet.vi](#). If the write queue becomes empty due to frame transmissions, the last frame will be transmitted on each RTSI pulse until another frame is provided using [ncWriteNet.vi](#).

### On RTSI Input - Timestamp RTSI event

When the RTSI input transitions from low to high, a timestamp is measured and stored in the read queue of the Network Interface. The special RTSI frame uses the following format:

Arbitration ID:	40000001 hex
Timestamp:	Time when RTSI input transitioned from low to high
IsRemote:	3
DataLength:	RTSI signal detected ( <b>RTSI Signal</b> )
Data:	N/A (ignore)

When calling [ncReadNet.vi](#) or [ncReadNetMult.vi](#) to read frames from the Network Interface, you typically use the IsRemote field to differentiate RTSI timestamps from CAN frames. Refer to [ncReadNetMult.vi](#) for more information.



**Note** When you configure a DAQ card to pulse the RTSI signal periodically, do not exceed 1000 Hertz (pulse every millisecond). If the RTSI input is pulsed faster than 1kHz on a consistent basis, CAN performance will be adversely affected (for example, lost data frames).

### RTSI Output on Receiving CAN Frame

The Network Interface will output the RTSI signal whenever a CAN frame is stored in the read queue.

If the hardware is Series 2, NI-CAN connects a special pin of the Philips SJA1000 CAN controller to the RTSI output. This hardware connection provides jitter in the nanoseconds range, enabling triggering of external oscilloscopes and so on.



### RTSI Output on Transmitting CAN Frame

The Network Interface will output the RTSI signal whenever a CAN frame is successfully transmitted from the write queue.

### RTSI Output on ncAction call

The Network Interface will output the RTSI signal whenever **ncAction.vi** is called with **Opcode** Output on RTSI line. This RTSI mode can be used to manually toggle/pulse a RTSI output within the application.



**RTSI Signal** defines the RTSI signal associated with the **RTSI Mode**. Valid values are 0 to 6, corresponding to RTSI 0 to RTSI 6 on other National Instruments cards.

Series 1 and 2 CAN cards each have limitations regarding RTSI. For information on these limitations, refer to the [Valid Combinations of Source/Destination](#) section in the [ncConnectTerminals.vi](#) function reference.



**RTSI Behavior** specifies whether to pulse or toggle a RTSI output. This attribute is ignored when **RTSI Mode** specifies input (which are always detected low to high):

Output RTSI Pulse:	Pulse the RTSI output. For Series 1 CAN cards, the pulse is at least 100 $\mu$ s. For Series 2 CAN cards, the pulse is at least 100 ns.
Toggle RTSI Line:	If the previous state was high, the output toggles low, then vice-versa.



**RTSI Skip** specifies the number of RTSI inputs (low-to-high transitions) to skip for **RTSI Mode** On RTSI Input - Timestamp RTSI event, and On RTSI Input - Transmit CAN Frame. It is ignored for all other **RTSI Mode** values. For example, if the RTSI input transitions every 1 ms, **RTSI Skip** of 9 means that a timestamp will be stored in the read queue every 10 ms.



**Error in** describes error conditions occurring before the VI executes. If an error has already occurred, the VI returns the value of the **Error in** cluster in **Error out**.



**status** is True if an error occurred. If **status** is True, the VI does not perform any operations.



**code** is the error code number identifying an error. A value of 0 means success. A negative value means error: VI did not execute

the intended operation. A positive value means warning: VI executed intended operation, but an informational warning is returned. For a description of the **code**, wire the error cluster to a LabVIEW error-handling VI, such as the Simple Error Handler.



**source** identifies the VI where the error occurred.

## Output



**Error out** describes error conditions. If the **Error in** cluster indicated an error, the **Error out** cluster contains the same information. Otherwise, **Error out** describes the error status of this VI.



**status** is True if an error occurred.



**code** is the error code number identifying an error. A value of 0 means success. A negative value means error: VI did not execute the intended operation. A positive value means warning: VI executed intended operation, but an informational warning is returned. For a description of the **code**, wire the error cluster to a LabVIEW error-handling VI, such as the Simple Error Handler.



**source** identifies the VI where the error occurred.

## Description

RTSI is a bus that interconnects National Instruments DAQ, IMAQ, Motion, and CAN boards. This feature allows synchronization of DAQ, IMAQ, Motion, and CAN boards by allowing exchange of timing signals. Using RTSI, a device (board) can control one or more slave devices.

If you are not using RTSI features to synchronize the Network Interface with other National Instruments cards, refer to [ncConfigCANNET.vi](#).

The 847x and 847x with Sync series LIN interfaces do not support [ncConfigCANNETRTSI.vi](#).

## ncConfigCANObj.vi

### Purpose

Configure a CAN Object before using it.

### Format

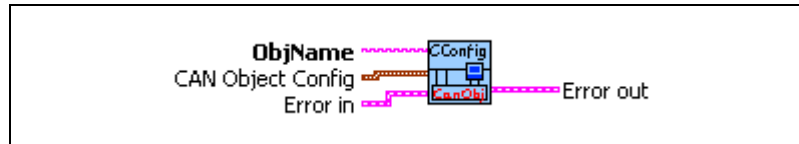

### Input



**ObjName** is the name of the CAN Object to configure. This name uses the syntax “CANx::STDy” or “CANx::XTDy”. CANx is the name of the CAN network interface that you used for the preceding [ncConfigCANNet.vi](#). STD indicates that the CAN Object uses a standard (11-bit) arbitration ID. XTD indicates that the CAN Object uses an extended (29-bit) arbitration ID. The number y specifies the actual arbitration ID of the CAN Object. The number y is decimal by default, but you also can use hexadecimal by adding **0x** to the beginning of the number. For example, “CAN0::STD25” indicates standard ID 25 decimal on CAN0, and “CAN1::XTD0x0000F652” indicates extended ID F652 hexadecimal on CAN1.

The special virtual interface names “CAN256” and “CAN257” are not supported for CAN Objects.

The 847x and 847x with Sync series CAN and LIN interfaces do not support **ncConfigCANObj.vi**.



**CAN Object Config** provides the core configuration attributes of the CAN Object. This cluster uses the typedef **ncObjAttr.ctl**. You can wire in the cluster by first placing it on the front panel from the NI-CAN Controls palette, or you can right-click the VI input and select **Create Constant** or **Create Control**.



**Period** specifies the rate of periodic behavior in milliseconds.

The behavior depends on the **Communication Type** as follows:

**Transmit Data Periodically, Transmit Periodic Waveform,  
Receive Periodic Using Remote**

**Period** specifies the time between subsequent transmissions, and must be set greater than zero.

#### Receive Unsolicited, Transmit by Response Only

**Period** specifies a watchdog timeout. If a frame is not received at least once every period, a timeout error is returned. Setting **Period** to zero disables the watchdog timer.

#### Transmit Data by Call, Receive by Call Using Remote

**Period** specifies a minimum interval between subsequent transmissions. Even if **ncWriteObj.vi** is called very frequently, frames are transmitted on the network at a rate no more than **Period**. Setting **Period** to zero disables the minimum interval timer.



**Read Queue Length** is the maximum number of unread frames for the read queue of the CAN Object. For more information, refer to **ncReadObj.vi**.

If **Communication Type** is set to receive data, a typical value is 10. If **Communication Type** is set to transmit data, a typical value is 0.



**Write Queue Length** is the maximum number of frames for the write queue of the CAN Object awaiting transmission. For more information, refer to **ncWriteObj.vi**.

If **Communication Type** is set to receive data, a typical value is 0. If **Communication Type** is set to transmit data, a typical value is 10.



**Receive Changes Only** applies only to **Communication Type** selections in which the CAN Object receives data frames (ignored for other types). For those configurations, **Receive Changes Only** specifies whether duplicated data should be placed in the read queue. When set to False (default), all data frames for the CAN Object ID are placed in the read queue. When set to True, data frames are placed into the read queue only if the data bytes differ from the previously received data bytes in the read queue.

This attribute has no effect on the usage of a watchdog timeout for the CAN Object. For example, if this attribute is True and you also specify a watchdog timeout, NI-CAN restarts the watchdog timer every time it receives a data frame for the ID of the CAN Object, regardless of whether the data differs from the previous frame.



**Communication Type** specifies the behavior of the CAN Object with respect to its ID, including the direction of data transfer:

#### Receive Unsolicited

Receive data frames for a specific ID.

This type is useful for receiving a few IDs (1-10) into dedicated read queues. For high performance applications (more IDs, fast frame rates), the Network Interface is recommended to receive all IDs.

**Period** specifies a watchdog timeout, and **Receive Changes Only** specifies whether to place duplicate data frames into the read queue. **Transmit by Response** is ignored.

#### Receive Periodic Using Remote

Periodically transmit remote frame for a specific ID in order to receive the associated data frame. Every **Period**, the CAN Object transmits a remote frame, and then places the resulting data frame response in the read queue.

If the data frame is not received in response to the transmit remote frame, the periodic transmission is put on hold.

**Period** specifies the periodic rate, and **Receive Changes Only** specifies whether to place duplicate data frames into the read queue. **Transmit by Response** is ignored.

#### Receive by Call Using Remote

Transmit remote frame for a specific ID by calling [ncWriteObj.vi](#). The CAN Object places the resulting data frame response in the read queue.

**Period** specifies a minimum interval, and **Receive Changes Only** specifies whether to place duplicate data frames into the read queue. **Transmit by Response** is ignored.

#### Transmit Data Periodically

Periodically transmit data frame for a specific ID. When the CAN Object transmits the last entry from the write queue, that entry is used every period until you provide a new data frame using [ncWriteObj.vi](#). If you keep the write queue filled with unique data, this behavior allows you to ensure that each period transmits a unique data frame.

If the write queue is empty when communication starts, the first periodic transmit does not occur until you provide the first data frame with [ncWriteObj.vi](#).

**Period** specifies the periodic rate, and **Transmit by Response** specifies whether to transmit the data of the previous period in response to a remote frame. If **Transmit by Response** is true, the data from the previous (periodic) transmit will be retransmitted in case a remote frame is received, even if there are frames pending in the write buffer. **Receive Changes Only** is ignored.

#### Transmit by Response Only

Transmit data frame for a specific ID only in response to a received remote frame. When you call **ncWriteObj.vi**, the data is placed in the write queue, and remains there until a remote frame is received. The number of objects for the communication type usable at the same time is limited to 12.

**Period** specifies a watchdog timeout. **Transmit by Response** is assumed as True regardless of the attribute setting. **Receive Changes Only** is ignored.

#### Transmit Data by Call

Transmit data frame when **ncWriteObj.vi** is called. When **ncWriteObj.vi** is called quickly, data frames are placed in the write queue for back to back transmit.

**Period** specifies a minimum interval, and **Transmit by Response** specifies whether to transmit the previous data frame in response to a remote frame. **Receive Changes Only** is ignored.

#### Transmit Periodic Waveform

Transmit a fixed sequence of data frames over and over, one data frame every **Period**.

The following steps describe typical usage of this type.

1. Configure CAN Network Interface Object with **Start On Open** False, then open the Network Interface.
2. Configure the CAN Object as Transmit Periodic Waveform and a nonzero **Write Queue Length**, then open the CAN Object.
3. Call **ncWriteObj.vi** for the CAN Object, once for every entry specified for the **Write Queue Length**.
4. Use **ncAction.vi** to start the Network Interface (not the CAN Object). The CAN Object transmits the first frame in the write queue, then waits the specified period, then transmits the second frame, and so on. After the last frame is transmitted, the CAN Objects waits the specified period, then transmits the first frame again.

If you need to change the waveform contents at runtime, or if you need to transmit very large waveforms (more than 100 frames), we recommend using the Transmit Data Periodically type. Using that type, you can write frames to the Write Queue until full (overflow error), then wait some time for a few frames to transmit, then continue writing new frames.

This communication type has the following limitations:

- **Write Queue Length** must be greater than zero.
- You must write exactly **Write Queue Length** values before starting communication (no less).
- Once communication is started, you cannot write additional values.

**Period** specifies the periodic rate. **Transmit by Response** and **Receive Changes Only** are ignored.



**Transmit By Response** applies only to **Communication Type** of Transmit Data by Call and Transmit Data Periodically (ignored for other types). For those configurations, **Transmit By Response** specifies whether the CAN Object should automatically respond with the previously transmitted data frame when it receives a remote frame. When set to False (default), the CAN Object transmits data frames only as configured, and ignores all remote frames for its ID. When set to True, the CAN Object responds to incoming remote frames.



**Data Length** specifies the number of bytes in the data frames for the ID of the CAN Object. This number is placed in the Data Length Code (DLC) of all transmitted data frames and remote frames for the CAN Object. This is also the number of data bytes returned from **ncReadObj.vi** when the communication type indicates receive.

## Examples of Different Communication Types

Figure 10-1, Figure 10-2, and Figure 10-3, demonstrate how you can use the Communication Type attribute for actual network data transfer. Each figure shows two separate NI-CAN applications that are physically connected across a CAN network.

Figure 10-1 shows a CAN Object that periodically transmits data to another CAN Object. The receiving CAN Object can queue up to five data values.

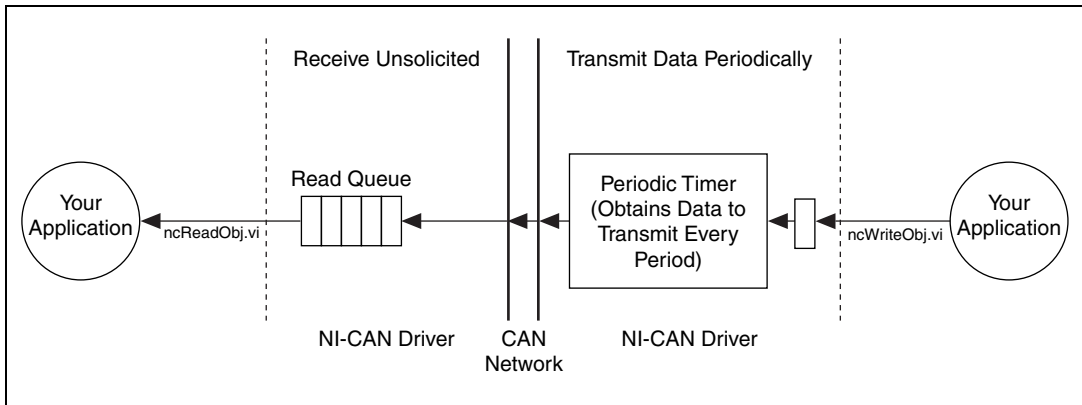

Figure 10-1. Example of Periodic Transmission

### Example of Periodic Transmission

Figure 10-2 shows a CAN Object that polls data from another CAN Object. NI-CAN transmits the CAN remote frame when you call **ncWriteObj.vi**.

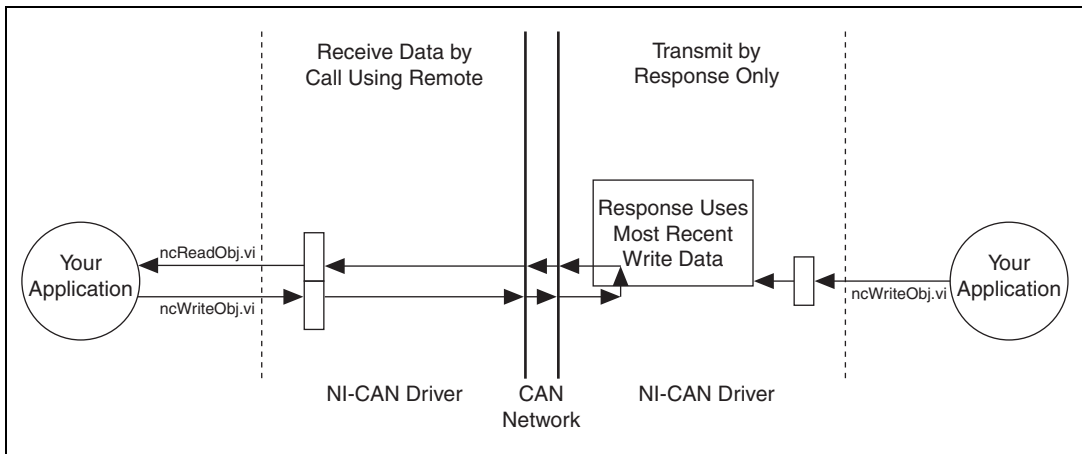
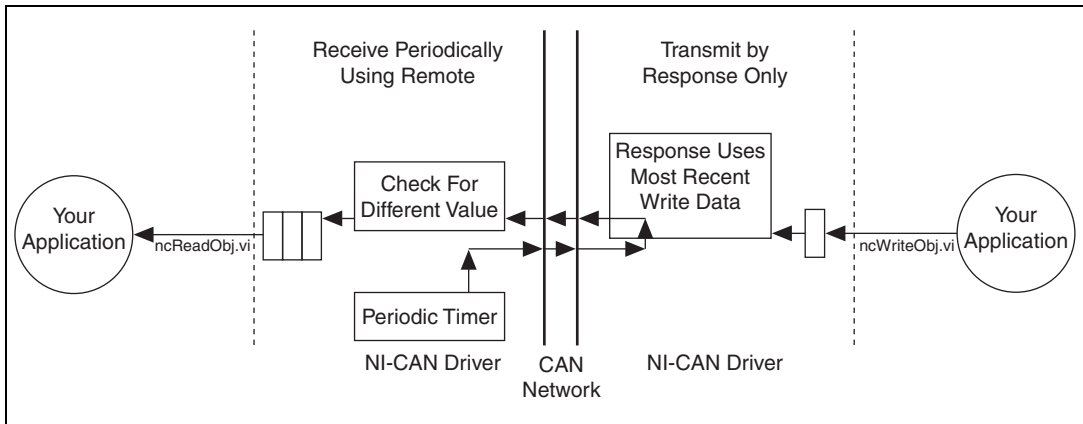

Figure 10-2. Example of Polling Remote Data Using ncWriteObj.vi



Figure 10-3 shows a CAN Object that polls data from another CAN Object. NI-CAN transmits the remote frame periodically and places only changed data into the read queue.



**Figure 10-3.** Example of Periodic Polling of Remote Data



**Error in** describes error conditions occurring before the VI executes. If an error has already occurred, the VI returns the value of the **Error in** cluster in **Error out**.



**status** is True if an error occurred. If **status** is True, the VI does not perform any operations.



**code** is the error code number identifying an error. A value of 0 means success. A negative value means error: VI did not execute the intended operation. A positive value means warning: VI executed intended operation, but an informational warning is returned. For a description of the **code**, wire the error cluster to a LabVIEW error-handling VI, such as the Simple Error Handler.



**source** identifies the VI where the error occurred.

## Output



**Error out** describes error conditions. If the **Error in** cluster indicated an error, the **Error out** cluster contains the same information. Otherwise, **Error out** describes the error status of this VI.



**status** is True if an error occurred.



**code** is the error code number identifying an error. A value of 0 means success. A negative value means error: VI did not execute the intended operation. A positive value means warning: VI

executed intended operation, but an informational warning is returned. For a description of the **code**, wire the error cluster to a LabVIEW error-handling VI, such as the Simple Error Handler.



**source** identifies the VI where the error occurred.

## Description

The CAN Object provides read/write access to a specific ID on the network.

You normally call **ncConfigCANNet.vi** before this VI in order to configure the Network Interface attributes, then call **ncConfigCANObj.vi** for each CAN Object desired.

If you intend to use RTSI features to synchronize the CAN Object with other National Instruments cards, refer to **ncConfigCANObjRTSI.vi**.

When a network frame is transmitted on a CAN-based network, it always begins with the arbitration ID. This arbitration ID is primarily used for collision resolution when more than one frame is transmitted simultaneously, but often is also used as a simple mechanism to identify data. The CAN arbitration ID, along with its associated data, is referred to as a CAN Object.

The NI-CAN implementation of CAN provides high-level access to CAN Objects on an individual basis. You can configure each CAN Object for different forms of communication (such as periodic polling, receiving unsolicited CAN data frames, and so on). After you configure a CAN Object and open it for communication, use the **ncReadObj.vi** and **ncWriteObj.vi** VIs to access the data of the CAN Object. The NI-CAN driver performs all other details regarding the object.

## ncConfigCANObjRTSI.vi

### Purpose

Configure a CAN Object with RTSI features.

### Format

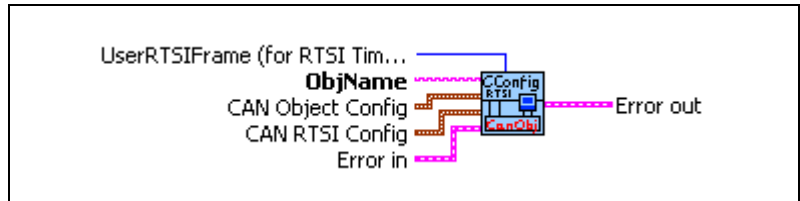

### Input



**ObjName** is the name of the CAN Object to configure. This name uses the syntax “CANx::STDy” or “CANx::XTDy”. CANx is the name of the CAN network interface that you used for the preceding [ncConfigCANNET.vi](#) VI. STD indicates that the CAN Object uses a standard (11-bit) arbitration ID. XTD indicates that the CAN Object uses an extended (29-bit) arbitration ID. The number y specifies the actual arbitration ID of the CAN Object. The number y is decimal by default, but you also can use hexadecimal by adding “0x” to the beginning of the number. For example, “CAN0::STD25” indicates standard ID 25 decimal on CAN0, and “CAN1::XTD0x0000F652” indicates extended ID F652 hexadecimal on CAN1.

The 847x and 847x with Sync series CAN and LIN interfaces do not support [ncConfigCANObjRTSI.vi](#).



**CAN Object Config** provides the core configuration attributes of the CAN Object. This cluster uses the typedef [ncObjAttr.ctl](#). You can wire in the cluster by first placing it on the front panel from the NI-CAN Controls palette, or you can right-click the VI input and select **Create Constant** or **Create Control**. (For more information, refer to [ncConfigCANObj.vi](#).)



**CAN RTSI Config** provides RTSI configuration attributes for the CAN Object. This cluster uses the typedef [ncCANRtsiAttr.ctl](#). You can wire in the cluster by first placing it on the front panel from the NI-CAN Controls palette, or you can right-click the VI input and select **Create Constant** or **Create Control**.



**RTSI Mode** specifies the behavior of the CAN Object with respect to RTSI, including whether the RTSI signal is an input or output.

### Disable RTSI

Disables RTSI behavior for the CAN Object. All other RTSI attributes are ignored. Using this mode is equivalent to calling [ncConfigCANObj.vi](#).

### On RTSI Input - Transmit CAN Frame

The CAN Object will transmit a frame from its write queue when the RTSI input transitions from low to high. To begin transmission, at least one data frame must be written using [ncWriteObj.vi](#). If the write queue becomes empty due to frame transmissions, the last frame will be transmitted on each RTSI pulse until another frame is provided using [ncWriteObj.vi](#).

In order to use this **RTSI Mode**, you must configure the **Communication Type** of the CAN Object to either Transmit Data by Call, Transmit Data Periodically, or Transmit Periodic Waveform. The **Period** attribute is ignored when this RTSI mode is selected.

### On RTSI Input - Timestamp RTSI event

When the RTSI input transitions from low to high, a timestamp is measured and stored in the read queue of the CAN Object. The special RTSI frame uses the following format:

Timestamp:	Time when RTSI input transitioned from low to high
Data:	User-defined 4 byte data pattern (refer to <b>UserRTSIFrame</b> for details)



**Note** When you configure a DAQ card to pulse the RTSI signal periodically, do not exceed 1000 Hertz (pulse every millisecond). If the RTSI input is pulsed faster than 1kHz on a consistent basis, CAN performance will be adversely affected (for example, lost data frames).

### RTSI Output on Receiving CAN Frame

The CAN Object will output the RTSI signal whenever a CAN frame is stored in the read queue.

In order to use this **RTSI Mode**, you must configure the **Communication Type** of the CAN Object to Receive Unsolicited.

### RTSI Output on Transmitting CAN Frame

The CAN Object will output the RTSI signal whenever a CAN frame is successfully transmitted.

In order to use this **RTSI Mode**, you must configure the **Communication Type** of the CAN Object to either Transmit Data by Call, Transmit Data Periodically, or Transmit Periodic Waveform.

### RTSI Output on ncAction.vi call

The CAN Object will output the RTSI signal whenever **ncAction.vi** is called with Opcode Output on RTSI line. This RTSI mode can be used to manually toggle/pulse a RTSI output within the application.



**RTSI Signal** defines the RTSI signal associated with the **RTSI Mode**. Valid values are 0 to 6, corresponding to RTSI 0 to RTSI 6 on other National Instruments cards.

Series 1 and 2 CAN cards each have limitations regarding RTSI. For information on these limitations, refer to the [Valid Combinations of Source/Destination](#) section in the [ncConnectTerminals.vi](#) function reference.



**RTSI Behavior** specifies whether to pulse or toggle a RTSI output. This attribute is ignored when **RTSI Mode** specifies input (always detected low to high):

**Output RTSI Pulse:** Pulse the RTSI output. For Series 1 CAN cards, the pulse is at least 100  $\mu$ s. For Series 2 CAN cards, the pulse is at least 100 ns.

**Toggle RTSI Line:** If the previous state was high, the output toggles low, then vice-versa.



**RTSI Skip** specifies the number of RTSI inputs (low-to-high transitions) to skip for **RTSI Mode** On RTSI Input - Timestamp RTSI event, and On RTSI Input - Transmit CAN Frame. It is ignored for all other **RTSI Mode** values. For example, if the RTSI input transitions from low to high every 1 ms, **RTSI Skip** of 9 means that a timestamp will be stored in the read queue every 10 ms.



**UserRTSIFrame** specifies a 4-byte pattern used to differentiate RTSI timestamps from CAN data frames. It is provided as a U32, and the high byte is stored as byte 0 from **ncReadObj.vi**. For example, **AABBCCDD** hexadecimal is returned as **AA** in byte 0, **BB** in byte 1, and so on.

This attribute is used only for **RTSI Mode** On RTSI Input - Timestamp RTSI event. It is ignored for all other **RTSI Mode** values.



**Error in** describes error conditions occurring before the VI executes. If an error has already occurred, the VI returns the value of the **Error in** cluster in **Error out**.



**status** is True if an error occurred. If **status** is True, the VI does not perform any operations.



**code** is the error code number identifying an error. A value of 0 means success. A negative value means error: VI did not execute the intended operation. A positive value means warning: VI executed intended operation, but an informational warning is returned. For a description of the **code**, wire the error cluster to a LabVIEW error-handling VI, such as the Simple Error Handler.



**source** identifies the VI where the error occurred.

## Output



**Error out** describes error conditions. If the **Error in** cluster indicated an error, the **Error out** cluster contains the same information. Otherwise, **Error out** describes the error status of this VI.



**status** is True if an error occurred.



**code** is the error code number identifying an error. A value of 0 means success. A negative value means error: VI did not execute the intended operation. A positive value means warning: VI executed intended operation, but an informational warning is returned. For a description of the **code**, wire the error cluster to a LabVIEW error-handling VI, such as the Simple Error Handler.



**source** identifies the VI where the error occurred.

## Description

RTSI is a bus that interconnects National Instruments DAQ, IMAQ, Motion, and CAN boards. This feature allows synchronization of DAQ, IMAQ, Motion, and CAN boards by allowing exchange of timing signals. Using RTSI, a device (board) can control one or more slave devices.

If you are not using RTSI features to synchronize the CAN Object with other National Instruments cards, refer to [ncConfigCANObj.vi](#).

## ncConnectTerminals.vi

### Purpose

Connect a terminal in the CAN or LIN hardware.

### Format

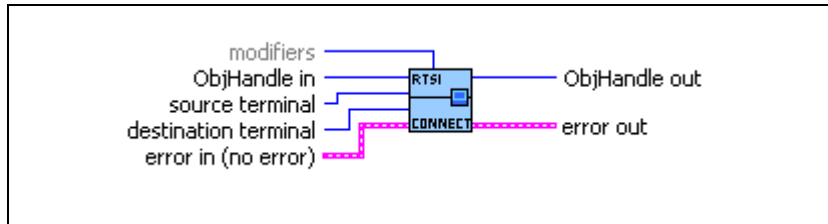

### Inputs



**ObjHandle in** is the object handle from the previous NI-CAN VI. The handle reference originated from [ncOpen.vi](#).



**source terminal** specifies the source of the connection. Once the connection is successfully created, behavior flows from **source terminal** to **destination terminal**.

For a list of valid source/destination pairs, refer to the [Valid Combinations of Source/Destination](#) section at the end of this function.

The following list describes each value of **source terminal**:

#### RTSI0 ... RTSI6

Selects a general-purpose RTSI line as source (input) of the connection.

#### RTSI7/RTSI Clock

Selects RTSI line 7 as source (input) of the connection. **RTSI7** is dedicated for routing of a timebase. **RTSI7** is also known as **RTSI Clock** in some National Instruments software products, such as NI-DAQ.

For PCI and PXI form factors, this receives a 20 MHz (default) timebase from another CAN or DAQ card. For example, you can synchronize a CAN and DAQ E Series MIO card by connecting the 20 MHz oscillator (board clock) of the DAQ card to **RTSI7/RTSI**



**Clock**, and then connecting **RTSI7/RTSI Clock** to **Master Timebase** on the CAN card.

For PCMCIA form factor, a 10 MHz timebase is required on **RTSI7/RTSI Clock**. For synchronization with a PCMCIA DAQ card, this is done by programming **FREQOUT** signal of the DAQ card to 10 MHz, then wiring **FREQOUT** to the **RTSI7/RTSI Clock** of the CAN card.

For the 847x with Sync series CAN and LIN interfaces, 1 MHz, 10 MHz, and 20 MHz are valid timebases. Refer to Appendix E, [Specifications](#), for details on synchronization triggers.

This value does not apply to Series 1.

### **PXI\_Star**

**PXI\_Star** selects the PXI star trigger signal.

Within a PXI chassis, some PXI products can source a star trigger from Slot 2 to all higher-numbered slots. **PXI\_Star** enables the PXI CAN card to receive the star trigger when it is in Slot 3 or higher.

This value applies to Series 2 PXI CAN cards only.

### **PXI\_Clk10**

**PXI\_Clk10** selects the PXI 10 MHz backplane clock.

This routes the 10 MHz PXI backplane clock for use as the timebase of the CAN card. When you use **PXI\_Clk10** as the timebase for the CAN card, you must also use **PXI\_Clk10** as the timebase for other PXI cards to perform synchronized input/output.

This value applies to Series 2 PXI CAN cards only.

### **20 MHz Timebase**

**20 MHz Timebase** selects the local oscillator of the CAN or LIN hardware.

The only valid **destination terminal** for this source is **RTSI7/RTSI Clock**. This routes the local clock of the hardware for use as a timebase by other NI cards. For example, you can synchronize two CAN cards by connecting **20 MHz Timebase** to **RTSI7/RTSI Clock** on one CAN card and then connecting **RTSI7/RTSI Clock** to **Master Timebase** on the other CAN card.

**20 MHz Timebase** applies to the entire CAN or LIN hardware, including both interfaces of a 2-port CAN card.

This value applies to Series 2 PXI or PCI CAN cards and 847x with Sync interfaces only.

For 847x with Sync series CAN and LIN interfaces the internal oscillator runs at 1 MHz.

### 10 Hz Resync Clock

**10 Hz Resync Clock** selects a 10 Hz, 50 percent duty cycle clock. This slow rate is required for resynchronization of Series 1 CAN cards. On each pulse of the resync clock, the other CAN card brings its clock into sync.

By selecting **RTSI0** to **RTSI6** as the **destination terminal**, you route the 10 Hz clock to synchronize with other Series 1 CAN cards. NI-DAQ or NI-DAQmx cards cannot use the 10 Hz resync clock, so this selection is limited to synchronization of two or more CAN cards.

**10 Hz Resync Clock** applies to the entire CAN card, including both interfaces of a 2-port CAN card.

This value applies to Series 1 and Series 2 CAN cards, but is typically used with Series 1 CAN cards only. If all of the CAN cards are Series 2, the 20 MHz timebase is preferable due to the lack of drift. If you are using a mix of Series 1 and Series 2 CAN cards, you must use the **10 Hz Resync Clock**.

### Interface Receive Event

**Interface Receive Event** selects the dedicated receive interrupt output on the Philips SJA1000 CAN controller. When a received frame successfully passes the acceptance filter, a pulse with the width of one bit time is output during the last bit of the end of frame position of the CAN frame. Incoming CAN frames can be filtered using the **Series 2 Filter Mode** attribute.

The CAN controller is specified by the **ObjName** input to [ncOpen.vi](#).

The **Interface Receive Event** can be used as the start trigger for other NI cards, or for external instruments.

This value applies to Series 2 cards only.

### Interface Transceiver Event

**Interface Transceiver Event** selects the NERR signal from the CAN transceiver. The Low-Speed/Fault-Tolerant transceiver and the High-Speed transceiver provide the NERR signal. This signal asserts when the transceiver detects a fault. The default value of NERR is logic-high, which indicates no error.

The CAN controller is specified by the **ObjName** input to [ncOpen.vi](#).

This value applies to Series 2 CAN cards only.

## Start Trigger

**Start Trigger** selects the start trigger, the event that starts objects.

The start trigger is the same for all tasks using a given interface, as specified by the **ObjName** input to **ncOpen.vi**.

In the default (disconnected) state of the **Start Trigger** destination, the start trigger occurs when communication begins on the interface.

By selecting **RTSI0** to **RTSI6** as the **destination terminal**, you route the start trigger of this CAN or LIN hardware to the start trigger of other CAN, LIN, or DAQ hardware. This ensures that sampling begins at the same time on both cards. For example, you can synchronize two CAN cards by routing **Start Trigger** as the **source terminal** on one CAN card and then routing **Start Trigger** as the **destination terminal** on the other CAN card, with both cards using the same RTSI line for the connections.



**destination terminal** specifies the destination of the connection.

The following list describes each value of **destination terminal**:

### RTSI0 ... RTSI6

Selects a general-purpose RTSI line as destination (output) of the connection.

### RTSI7/RTSI Clock

Selects RTSI line 7 as destination (output) of the connection. **RTSI7** is dedicated for routing of a timebase. **RTSI7** is also known as **RTSI Clock** in some National Instruments software products, such as NI-DAQ or NI-DAQmx. Series 2 CAN cards can import a 10 MHz or 20 MHz timebase, but can export only a 20 MHz timebase. 847x with Sync cards can import 1 MHz, 10 MHz, or 20 MHz timebases, but can export only a 1 MHz timebase.

### Master Timebase

**Master Timebase** instructs the CAN or LIN hardware to use the source of the connection as the master timebase. The CAN or LIN hardware uses this master timebase for input sampling (including timestamps of received messages) as well as periodic output sampling.

For PCI and PXI form factors, you can use **RTSI7/RTSI Clock** as the **source terminal**. By default this receives a 20 MHz timebase from another CAN or DAQ card. For example, you can synchronize a CAN and DAQ E Series MIO card by connecting the 20 MHz oscillator (board clock) of the DAQ card to **RTSI7/RTSI Clock**, and then connecting **RTSI7/RTSI Clock** to **Master Timebase** on the CAN

card. To change the **Master Timebase Rate** to 10 MHz, use **ncSetAttr.vi** to change the **Master Timebase Rate** attribute.

For PXI form factor, you also can use **PXI\_Clk10** as the **source terminal**. This receives the PXI 10 MHz backplane clock for use as the master timebase.

For PCMCIA form factor, you can use **RTSI7/RTSI Clock** as the **source terminal**. Unlike PCI and PXI, the PCMCIA CAN card requires a 10 MHz timebase on **RTSI7/RTSI Clock**. For synchronization with a PCMCIA DAQ card, this is done by programming the **FREQOUT** signal of the DAQ card to 10 MHz, then wiring **FREQOUT** to the **RTSI7/RTSI Clock** of the CAN card.

For the USB form factor, you can use **RTSI7/RTSI Clock** as the source terminal. The USB hardware automatically senses the incoming clock rate of 1 MHz, 10 MHz, or 20 MHz, so no further configuration is required.

**Master Timebase** applies to the entire CAN or LIN hardware, including both interfaces of a 2-port CAN card.

The default (disconnected) state of this destination means the CAN or LIN hardware uses its local timebase as the master timebase.

### 10 Hz Resync Clock

**10 Hz Resync Clock** instructs the CAN card to use a 10 Hz, 50 percent duty cycle clock to resynchronize its local timebase. This slow rate is required for resynchronization of CAN cards. On each low-to-high transition of the resync clock, this CAN card brings its local timebase into sync.

When synchronizing to an E Series MIO card, a typical use of this value is to use **RTSI0** to **RTSI6** as the **source terminal**, then use NI-DAQ or NI-DAQmx functions to program the Counter 0 of the MIO card to generate a 10 Hz 50 percent duty cycle clock on the RTSI line.

When synchronizing to a CAN card, a typical use of this value is to use **RTSI0** to **RTSI6** as the **source terminal**, then route the **10 Hz Resync Clock** of the other CAN card as the **source terminal** to the same RTSI line.

**10 Hz Resync Clock** applies to the entire CAN card, including both interfaces of a 2-port CAN card. The CAN card is specified by the **ObjName** input to **ncOpen.vi**.

The default (disconnected) state of this destination means the CAN card does not resynchronize its local timebase.

This value applies to Series 1 and Series 2 CAN cards, but is typically used with Series 1 CAN cards only. If all of the CAN cards are Series 2, the 20 MHz timebase is preferable due to the lack of drift. If you are using a mix of Series 1 and Series 2 CAN cards, you must use the **10 Hz Resync Clock**.

### Start Trigger

Start Trigger selects the start trigger, the event that starts communication for all CAN objects on the same port. The start trigger occurs on the first low-to-high transition of the source terminal.

The start trigger is the same for all CAN Objects using a given interface, as specified by the **ObjName** input to **ncOpen.vi**.

By selecting **RTSI0** to **RTSI6**, or **PXI\_Star** for PXI hardware, as the **source terminal**, you route the start trigger from another CAN, LIN, or DAQ card. This ensures that sampling begins at the same time on both cards. For example, you can synchronize with an E Series DAQ MIO card by routing the AI start trigger of the MIO card to a RTSI line and then routing the same RTSI line with **Start Trigger** as the **destination terminal** on the CAN card.

The default (disconnected) state of this destination means the start trigger occurs when communication begins on the interface.



**modifiers** provides optional connection information for certain source/destination pairs. The current release of NI-CAN does not use this information for any source/destination pair, so **modifiers** must be left unwired.



**Error in** describes error conditions occurring before the VI executes. If an error has already occurred, the VI returns the value of the **Error in** cluster in **Error out**.



**status** is True if an error occurred. If **status** is True, the VI does not perform any operations.



**code** is the error code number identifying an error. A value of 0 means success. A negative value means error: VI did not execute the intended operation. A positive value means warning: VI executed intended operation, but an informational warning is returned. For a description of the **code**, wire the error cluster to a LabVIEW error-handling VI, such as the Simple Error Handler.



**source** identifies the VI where the error occurred.

## Outputs



**ObjHandle out** is the object handle for the next VI.



**Error out** describes error conditions. If the **Error in** cluster indicated an error, the **Error out** cluster contains the same information. Otherwise, **Error out** describes the error status of this VI.



**status** is True if an error occurred.



**code** is the error code number identifying an error. A value of 0 means success. A negative value means error: VI did not execute the intended operation. A positive value means warning: VI executed intended operation, but an informational warning is returned. For a description of the **code**, wire the error cluster to a LabVIEW error-handling VI, such as the Simple Error Handler.



**source** identifies the VI where the error occurred.

## Description

This VI connects a specific pair of source/destination terminals. One of the terminals is typically a RTSI signal, and the other terminal is an internal terminal in the CAN or LIN hardware. By connecting internal terminals to RTSI, you can synchronize the CAN or LIN hardware with another hardware product such as an NI-DAQ or NI-DAQmx card.

When the final CAN object for a given port is cleared with **ncClose.vi**, NI-CAN disconnects all terminal connections for that port. Therefore, **ncDisconnectTerminals.vi** is not required for most applications. NI-DAQ and NI-DAQmx terminals remain connected after the CAN objects are cleared, so you must disconnect NI-DAQ and NI-DAQmx terminals manually at the end of the application.

For a list of valid source/destination pairs, refer to the following section.

### Valid Combinations of Source/Destination

The series of the NI CAN hardware determines what combinations of **source terminal** to **destination terminal** are valid. Within the table, 1 indicates Series 1 hardware, 2 indicates Series 2 hardware, and 3 indicates 847x with Sync hardware. You can determine the series of the NI CAN hardware by selecting the name of the card within the **Devices and Interfaces» NI-CAN Devices** view in the left pane of MAX.

Series 1 hardware has the following limitations.

- PXI cards do not support **RTSI6**.
- Signals received from a RTSI source cannot occur faster than 1 kHz. This prevents the card from receiving a 10 MHz or 20 MHz timebase, such as NI E Series MIO hardware provides.

- Signals received from a RTSI source must be at least 100  $\mu$ s in length to be detected. This prevents the card from receiving triggers in the nanoseconds range, such as the AI trigger that E Series MIO hardware provides. Series 2 CAN cards also send RTSI pulses in the nanoseconds range, so Series 1 CAN cards cannot receive RTSI input from Series 2 CAN cards.
- For CAN cards with High-Speed (HS) ports only, four RTSI signals are available for input (source), and four RTSI signals are available for output (destination). This limitation applies to the number of signals per direction, not the RTSI signal number. For example, if you connect **RTSI0**, **RTSI1**, **RTSI3**, and **RTSI5** as input, connecting **RTSI4** as input will return an error.
- For CAN cards with one or more Low-Speed (LS) ports, two RTSI signals are available for input (source), and three RTSI signals are available for output (destination).

Series 2 hardware has the following limitations.

- For all form factors (PCI, PXI, PCMCIA), the connection of **Interface Transceiver Event** to a RTSI destination depends on the physical port location. If the interface is on Port 1, you can connect to only even-numbered RTSI lines (**RTSI0**, **RTSI2**, **RTSI4**, **RTSI6**). If the interface is on Port 2, you can connect to only odd-numbered RTSI lines (**RTSI1**, **RTSI3**, **RTSI5**). You can determine the location by selecting the name of the interface in MAX.
- PCI cards do not support the **PXI\_Star** and **PXI\_Clk10** terminals, as those signals exist on the PXI backplane.
- PCMCIA cards do not support the **20 MHz Timebase**, **PXI\_Star**, and **PXI\_Clk10** terminals. Because **20 MHz Timebase** is not supported, you cannot synchronize the timebases of two PCMCIA CAN cards.
- On PCMCIA cards, **RTSI4**, **RTSI5** and **RTSI6** are not available.

847x with Sync series hardware has the following limitations:

- No support for **RTSI1–RTSI6**.
- Because 20 MHz timebase only outputs a 1 MHz signal, you cannot source a timebase to a PCI-CAN device. It can, however, receive a 20 MHz signal from a PCI-CAN device.
- **RTSI0** must be connected to the TRIG terminal and **RTSI7** must be connected to the CLK terminal. Refer to the [USB-LIN](#) section of Chapter 3, *NI CAN and LIN Hardware*, for more information on the pinout of the USB-847x with Sync series hardware.

Table 10-4 lists all valid combinations of **source terminal** and **destination terminal**.

**Table 10-4.** Valid Combinations of Source/Destination

Source	Destination				
	RTSI0 to RTSI6	RTSI_CLO CK	Master Timebase	10 Hz Resync Clock	Start Trigger
RTSI0 to RTSI6	—	—	—	1,2	1,2,3
RTSI7/RTSI Clock	—	—	2,3	—	—
PXI_Star	—	—	—	—	2
PXI_Clk10	—	—	2	—	—
20 MHz Timebase	—	2,3	—	—	—
10 Hz Resync Clock	1,2	—	—	—	1,2
Interface Receive Event	2	—	—	—	2
Interface Transceiver Event	2	—	—	—	—
Start Trigger Event	1,2,3	—	—	—	—

1—Valid connection for Series 1 hardware

2—Valid connection for Series 2 hardware

3—Valid connection for 847x with Sync series hardware



## ncDisconnectTerminals.vi

### Purpose

Disconnect terminals in the CAN or LIN hardware.

### Format

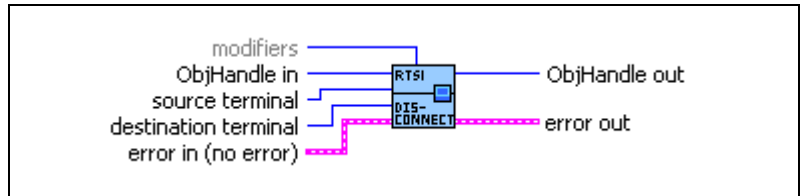

### Inputs



**ObjHandle in** is the object handle from the previous NI-CAN VI. The handle reference originated from [ncOpen.vi](#).



**source terminal** specifies the connection source. For a description of values for **source terminal**, refer to [ncConnectTerminals.vi](#).



**destination terminal** specifies the connection destination.

For a description of values for **destination terminal**, refer to [ncConnectTerminals.vi](#).



**modifiers** provides optional connection information for certain source/destination pairs. The current release of NI-CAN does not use this information for any source/destination pair, so **modifiers** must be left unwired.



**Error in** describes error conditions occurring before the VI executes. If an error has already occurred, the VI returns the value of the **Error in** cluster in **Error out**.



**status** is True if an error occurred. If **status** is True, the VI does not perform any operations.



**code** is the error code number identifying an error. A value of 0 means success. A negative value means error: VI did not execute the intended operation. A positive value means warning: VI executed intended operation, but an informational warning is returned. For a description of the **code**, wire the error cluster to a LabVIEW error-handling VI, such as the Simple Error Handler.



**source** identifies the VI where the error occurred.

## Outputs



**ObjHandle out** is the object handle for the next VI.



**Error out** describes error conditions. If the **Error in** cluster indicated an error, the **Error out** cluster contains the same information. Otherwise, **Error out** describes the error status of this VI.



**status** is True if an error occurred.



**code** is the error code number identifying an error. A value of 0 means success. A negative value means error: VI did not execute the intended operation. A positive value means warning: VI executed intended operation, but an informational warning is returned. For a description of the **code**, wire the error cluster to a LabVIEW error-handling VI, such as the Simple Error Handler.



**source** identifies the VI where the error occurred.

## Description

This VI disconnects a specific pair of source/destination terminals that were previously connected with [ncConnectTerminals.vi](#).

When the final task for a given interface is cleared with [ncClose.vi](#), NI-CAN disconnects all terminal connections for that interface. Therefore, [ncDisconnectTerminals.vi](#) is not required for most applications. This VI is typically used to change RTSI connections dynamically while an application is running. First, use [ncAction.vi](#) to stop all tasks for the interface, then use [ncDisconnectTerminals.vi](#) and [ncConnectTerminals.vi](#) to adjust RTSI connections. Then use [ncAction.vi](#) with the opcode to start the network interface and higher-level CAN Objects to restart communication.

## ncGetAttr.vi

### Purpose

Get the value of an object attribute.

### Format

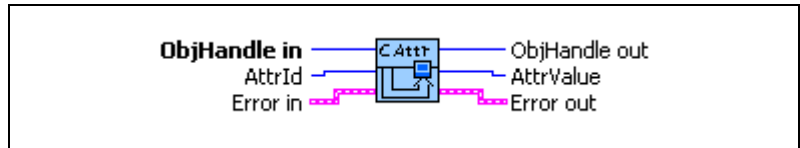

### Input



**ObjHandle in** is the object handle from the previous NI-CAN VI. The handle originates from **ncOpen.vi**.



**AttrId** specifies the attribute to get.

#### Baud Rate

Returns the value of the **Baud Rate** as configured with **ncSetAttr.vi**.

#### Form Factor

Returns the form factor of the card on which the Network Interface or CAN Object is located.

The returned **Form Factor** is an enumeration.

0	PCI
1	PXI
2	PCMCIA
3	AT
4	USB

#### Interface Number

Returns the **Interface Number** of the port on which the Network Interface or CAN Object is located.

This is the same number that you used in the **ObjName** string of the previous Config and Open VIs.

**LIN Checksum Type**

Returns the value of the **LIN Checksum Type** attribute as configured with [ncSetAttr.vi](#).

**LIN Enable DLC Check**

Returns the value of the **LIN Enable DLC Check** as configured with [ncSetAttr.vi](#).

**LIN Log Wakeup**

Returns the value of the **LIN Log Wakeup** attribute as configured with [ncSetAttr.vi](#).

0	FALSE (default)
1	TRUE

**LIN Response Timeout**

Returns the value of the **LIN Response Timeout** attribute as configured with [ncSetAttr.vi](#).

**LIN Sleep**

Returns the value of the **LIN Sleep** attribute. This attribute may be updated by the user with [ncSetAttr.vi](#) or by the reception of a wakeup signal on the LIN bus.

**Listen Only?**

Returns the **Listen Only?** attribute as configured with [ncSetAttr.vi](#).

**Log Bus Errors?**

Returns the value of the **Log Bus Errors?** attribute as configured with [ncSetAttr.vi](#).

**Log Comm Warnings**

Returns TRUE or FALSE depending on whether communication warnings (including transceiver faults) were logged to the Network Interface read queue. For more information, refer to this attribute in [ncSetAttr.vi](#).

**Log Start Trigger?**

Returns the value of the **Log Start Trigger?** attribute as configured with [ncSetAttr.vi](#).

**Log Transceiver Faults?**

Returns the value of the **Log Transceiver Faults?** attribute as configured with [ncSetAttr.vi](#).

**Master Timebase Rate**

Returns the present **Master Timebase Rate** in MHz, programmed into the CAN Series 1 or Series 2 hardware. For PCMCIA, this attribute will always return 10 MHz.

For the 847x with Sync series CAN and LIN interfaces, this attribute returns the value that was automatically detected.

**Object State**

Returns the current state bit mask of the object. Polling with [ncGetAttr.vi](#) provides an alternative method of state detection than [ncWaitForState.vi](#). For more information on the states returned from this attribute, refer to the **DesiredState** input of [ncWaitForState.vi](#).

**Protocol Version**

For NI-CAN, this returns 02000200 hex, which corresponds to version 2.0B of the Bosch CAN specification and 2.0 of the LIN specification. For more information on the encoding of the version, refer to the **Software Version** attribute.

This attribute is available only from the Network Interface, not CAN Objects.

**Read Entries Pending**

Returns the number of frames available in the read queue. Polling the available frames with this attribute can be used as an alternative to [ncWaitForState](#).

**ReadMult Size for Notification**

Returns the number of frames used as a threshold for the Read Multiple state. For more information, refer to this attribute in [ncSetAttr.vi](#).

**Receive Error Counter**

Returns the **Receive Error Counter** from the SJA1000 CAN controller. This Receive Error Counter is specified in the Bosch CAN standard as well as ISO CAN standards.

This attribute is unsupported for Series 1 hardware (returns error). This attribute is available only from the Network Interface, not CAN Objects.

**Self Reception?**

Returns the Self Reception attribute as configured with [ncSetAttr.vi](#).

**Serial Number**

Returns the **Serial Number** of the card on which the Network Interface or CAN Object is located.

**Series**

Returns the **Series** of the card on which the Network Interface or CAN Object is located.

Series 1 hardware products use the Intel 82527 CAN controller.

Series 2 hardware products use the Philips SJA1000 CAN controller, plus improved RTSI synchronization features.

The 847x and 847x with Sync series CAN hardware products use the Philips SJA1000 CAN controller. The 847x and 847x with Sync series LIN hardware products use the AMTEL ATA6625 LIN controller.

The 847x with Sync series hardware products add synchronization features to the 847x hardware products.

The returned Series is an enumeration.

0	Series 1
1	Series 2
2	847x
3	847x with Sync

**Series 2 Comparator**

Returns the Series 2 Comparator attribute as configured with [ncSetAttr.vi](#).

This attribute is available only from the Network Interface, not CAN Objects.

This attribute is not supported for Series 1 CAN, 847x LIN, or 847x with Sync LIN interfaces (returns error).

**Series 2 Error/Arb Capture**

Returns the current values of the Error Code Capture register and Arbitration Lost Capture register from the Philips SJA1000 CAN controller chip.

The Error Code Capture register provides information on bus errors that occur according to the CAN standard. A bus error increments

either the **Transmit Error Counter** or the **Receive Error Counter**. When communication starts on the interface, the first bus error is captured into the Error Code Capture register, and retained until you get this attribute. After you get this attribute, the Error Code Capture register is again enabled to capture information for the next bus error.

The Arbitration Lost Capture register provides information on a loss of arbitration during transmits. Loss of arbitration is not considered an error. When communication starts on the interface, the first arbitration loss is captured into the Arbitration Lost Capture register, and retained until you get this attribute. After you get this attribute, the Arbitration Lost Capture register is again enabled to capture information for the next arbitration loss.

For each of the capture registers, a single-bit New flag indicates whether a new error has occurred since the last Get. If the New flag of a register is set, the associated fields contain new information. If the New flag of a register is clear, the associated fields are the same as the previous Get.

This attribute is commonly used with the **Single Shot Transmit?** attribute. When a Write function is used to transmit the single frame, you can get this attribute to determine if the transmit was successful. If the single shot transmit was not successful, this attribute provides detailed information for the failure.

This attribute is not supported for Series 1 CAN, 847x LIN, or 847x with Sync LIN interfaces (returns error). Since the information and bit format is very specific to the Philips SJA1000 CAN controller on Series 2 and 847x CAN hardware, National Instruments cannot guarantee compatibility for this attribute on future hardware series. When using this attribute in the application, it is best to get the **Series** to verify that the hardware is Series 2, 847x, or 847x with Sync.

Figure 10-4 and Table 10-5, Table 10-6, Table 10-7, Table 10-8, Table 10-9, and Table 10-10, describe the format of bit fields in this attribute. The lowest byte (bits 0–7) corresponds to the Error Code Capture register. The next byte (bits 8–15) corresponds to the Arbitration Lost Capture register. Bit 16 (00010000 hex) is the New flag for the Error Code Capture fields. Bit 17 (00020000 hex) is the New flag for the Arbitration Lost Capture field. Bits marked as X are reserved, and should be ignored by the application.

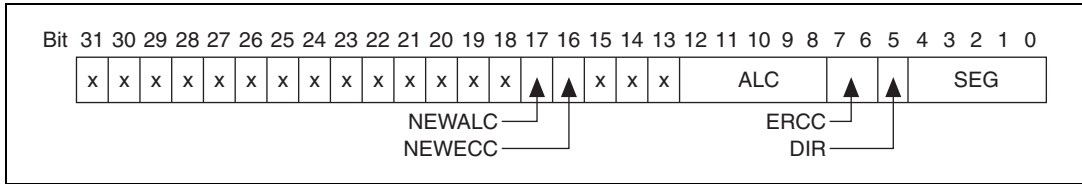

**Figure 10-4.** Series 2 Error/Arb Capture Format

**Table 10-5.** SEG Field of the Error Code Capture Register

Value in SEG Field	Meaning
0	No error (ignore DIR and ERRC as well)
2	ID.28 to ID.21 (most significant bits of identifier)
3	Start of frame
4	Bit SRTR (RTR for standard frames)
5	Bit IDE
6	ID.20 to ID.18
7	ID.17 to ID.13
8	CRC sequence
9	Reserved bit 0
10	Data field
11	Data length code
12	Bit RTR (RTR for extended frames)
13	Reserved bit 1
14	ID.4 to ID.0
15	ID.12 to ID.5
17	Active error flag
18	Intermission
19	Tolerate dominant bits
22	Passive error flag
23	Error delimiter



**Table 10-5.** SEG Field of the Error Code Capture Register (Continued)

<b>Value in SEG Field</b>	<b>Meaning</b>
24	CRC delimiter
25	Acknowledge slot
26	End of frame
27	Acknowledge delimiter
28	Overload flag

**Table 10-6.** DIR Field of the Error Code Capture Register

<b>Value in DIR Field</b>	<b>Meaning</b>
0	TX; error occurred during transmission
1	RX; error occurred during reception

**Table 10-7.** ERRC Field of the Error Code Capture Register

<b>Value in ERRC Field</b>	<b>Meaning</b>
0	Bit error
1	Form error
2	Stuff error
3	Other type of error

**Table 10-8.** ALC Field Contains the Arbitration Lost Capture Register

<b>Value in ALC Field</b>	<b>Meaning</b>
0	ID.28 (most significant bit of identifier; first ID bit in frame)
1	ID.27
2	ID.26

**Table 10-8.** ALC Field Contains the Arbitration Lost Capture Register (Continued)

<b>Value in ALC Field</b>	<b>Meaning</b>
3	ID.25
4	ID.24
5	ID.23
6	ID.22
7	ID.21
8	ID.20
9	ID.19
10	ID.18
11	SRTR (RTR for standard frames)
12	IDE
13	ID.17 (extended frames only)
14	ID.16 (extended frames only)
15	ID.15 (extended frames only)
16	ID.14 (extended frames only)
17	ID.13 (extended frames only)
18	ID.12 (extended frames only)
19	ID.11 (extended frames only)
20	ID.10 (extended frames only)
21	ID.9 (extended frames only)
22	ID.8 (extended frames only)
23	ID.7 (extended frames only)
24	ID.6 (extended frames only)
25	ID.5 (extended frames only)
26	ID.4 (extended frames only)
27	ID.3 (extended frames only)

**Table 10-8.** ALC Field Contains the Arbitration Lost Capture Register (Continued)

Value in ALC Field	Meaning
28	ID.2 (extended frames only)
29	ID.1 (extended frames only)
30	ID.0 (extended frames only)
31	SRTR (RTR for extended frames)

**Table 10-9.** NEWECC Field is the New Flag for the Error Code Capture Register

Value in NEWECC Field	Meaning
0	SEG, DIR, and ERRC fields contain the same value as the last Get of this attribute. If no error has occurred since the start of communication, all fields are zero.
1	SEG, DIR, and ERRC fields contain information for a new bus error.

**Table 10-10.** NEWALC Field is the New Flag for the Arbitration Lost Capture Register

Value in NEWALC Field	Meaning
0	ALC field contains the same value as the last Get of this attribute.
1	ALC field contains information for a new arbitration loss.

### Series 2 Filter Mode

Returns the Series 2 Filter Mode attribute as configured with [ncSetAttr.vi](#).

This attribute is available only from the Network Interface, not CAN Objects.

This attribute is not supported for Series 1 CAN, 847x LIN, or 847x with Sync LIN interfaces (returns error).

### Series 2 Mask

Returns the Series 2 Mask attribute as configured with [ncSetAttr.vi](#). This attribute is available only from the Network Interface, not CAN Objects.

This attribute is not supported for Series 1 CAN, 847x LIN, or 847x with Sync LIN interfaces (returns error).

### Single Shot Transmit?

Returns the Single Shot Transmit attribute as configured with [ncSetAttr.vi](#).

This attribute is not supported for Series 1 CAN, 847x LIN, or 847x with Sync LIN interfaces (returns error).

### Software Version

Version of the NI-CAN software, with major, minor, update, and beta build numbers encoded in the U32 from high to low bytes. For example, 2.0.1 would be 02000100 hex, and 2.1beta5 would be 02010005 hex.

This attribute is provided for backward compatibility. [ncGetHardwareInfo.vi](#) provides more complete version information.

### Termination

Returns the value of the **Termination** attribute as configured with [ncSetAttr.vi](#).

### Timeline Recovery

Returns the **Timeline Recovery** attribute for the CAN Network Interface Object.

### Timestamp Format

Returns the present Timestamp Format programmed into the CAN or LIN hardware. This attribute applies to the entire card.

### Transceiver External Inputs

Returns the **Transceiver External Inputs** for the Network Interface.

This attribute is available only for the Network Interface, not CAN Objects. Nevertheless, the attribute applies to communication by CAN Objects as well as the associated Network Interface.

Series 2 XS cards enable connection of an external transceiver. For an external transceiver, this attribute allows you to determine the input voltage on the STATUS pin of the CAN port.

For many models of CAN transceiver, an NERR pin is provided for detection of faults and other status. For such transceivers, you can wire the NERR pin to the STATUS pin of the CAN port.

This attribute is supported for Series 2 XS cards only (returns error for non-XS cards).

This attribute uses a bit mask. When using the attribute, use bitwise AND operations to check for values, not equality checks (equal, greater than, and so on).

#### **00000001 hex STATUS**

This bit is set when 5 V exists on the STATUS pin.

This bit is clear when 0 V exists on the STATUS pin.

### **Transceiver External Outputs**

Returns the **Transceiver External Outputs** for the Network Interface.

This attribute is available only for the Network Interface, not CAN Objects. Nevertheless, the attribute applies to communication by CAN Objects as well as the associated Network Interface.

Series 2 XS cards enable connection of an external transceiver. For an external transceiver, this attribute allows you to determine the output voltage on the MODE0 and MODE1 pins of the CAN port, and it allows you to determine if the CAN controller chip is sleeping.

For more information on the format of the value returned in this attribute, refer to the description of **Transceiver External Outputs** in [ncSetAttr.vi](#).

This attribute is supported for Series 2 XS cards only (returns error for non-XS cards).

### **Transceiver Mode**

Returns the **Transceiver Mode** for the Network Interface.

This attribute is available only for the Network Interface, not CAN Objects. Nevertheless, the attribute applies to communication by CAN Objects as well as the associated Network Interface.

This attribute is not supported for Series 1 CAN, 847x LIN, or 847x with Sync LIN interfaces (returns error).

For Series 2 cards for the PCMCIA form factor, this property requires a corresponding Series 2 cable (dongle). For information on how to identify the series of the PCMCIA cable, refer to the [Series 2 Vs. Series 1](#) section of Chapter 1, [Introduction](#).

The Transceiver Mode changes when you set the mode within the application, or when a remote wakeup transitions the interface from **Sleep** to **Normal** mode. For more information, refer to [ncSetAttr.vi](#).

This attribute uses the following values:

- |   |                        |  |
|---|------------------------|--|
| 0 | Normal                 | Transceiver is awake in normal communication mode.                 |
| 1 | Sleep                  | Transceiver and the CAN controller chip are both in sleep mode.    |
| 2 | Single Wire Wakeup     | Single Wire transceiver is in Wakeup Transmission mode.            |
| 3 | Single Wire High-Speed | Single Wire transceiver is in <b>High-Speed Transmission</b> mode. |

### Transceiver Type

Returns the type of transceiver for the Network Interface. For hardware other than Series 2 XS cards, the **Transceiver Type** is fixed. For Series 2 XS cards, the **Transceiver Type** reflects the most recent value specified by MAX or [ncSetAttr.vi](#).

This attribute is available only for the Network Interface, not CAN Objects. Nevertheless, the attribute applies to communication by CAN Objects as well as the associated Network Interface.

This attribute is not supported on the PCMCIA form factor.

This attribute uses the following values:

- |   |                          |  |
|---|--------------------------|--|
| 0 | High-Speed               | Transceiver type is High-Speed (HS).               |
| 1 | Low-Speed/Fault-Tolerant | Transceiver type is Low-Speed/Fault-Tolerant (LS). |
| 2 | Single Wire              | Transceiver type is Single Wire (SW).              |

## 3 External

Transceiver type is External. This transceiver type is available on Series 2 XS cards only. For more information, refer to [ncSetAttr.vi](#).

## 4 Disconnect

Transceiver type is Disconnect. This transceiver type is available on Series 2 XS cards only. For more information, refer to [ncSetAttr.vi](#).

## 5 LIN

Transceiver type is LIN.

### Transmit Error Counter

Returns the **Transmit Error Counter** from the Philips SJA1000 CAN controller. This **Transmit Error Counter** is specified in the Bosch CAN standard as well as ISO CAN standards.

This attribute is unsupported for Series 1 hardware (returns error). This attribute is available only from the Network Interface, not CAN Objects.

### Transmit Mode

Returns the **Transmit Mode** the CAN Network Interface Object is presently configured for.

The returned **Transmit Mode** is an enumeration.

0 Immediate Transmit

1 Timestamped Transmit

### User RTSI Frame

Returns the **User RTSI Frame** attribute as configured with [ncSetAttr.vi](#).

### Virtual Bus Timing

Returns a Boolean value of True or False to indicate whether **Virtual Bus Timing** has been set or not for the specified virtual interface. This attribute is applicable to all CAN Objects opened on the virtual interface.

### Write Entries Free

Returns the number of frames that can be accepted for a CAN or LIN Network Interface Object or CAN Object to write without causing overflow error.

### Write Entries Pending

Returns the number of frames pending transmission in the write queue. If the intent is to verify that all pending frames have been transmitted successfully, waiting for the Write Success state is preferable to this attribute.

The **Write Entries Pending** attribute for 847x and 847x with Sync series CAN and LIN interfaces does not return the number of frames pending transmission in the write queue because the number does not take into account the frames in transit over the USB or waiting to be transmitted to the interface over the USB.



**Error in** describes error conditions occurring before the VI executes. If an error has already occurred, the VI returns the value of the **Error in** cluster in **Error out**.



**status** is True if an error occurred. If **status** is True, the VI does not perform any operations.



**code** is the error code number identifying an error. A value of 0 means success. A negative value means error: VI did not execute the intended operation. A positive value means warning: VI executed intended operation, but an informational warning is returned. For a description of the **code**, wire the error cluster to a LabVIEW error-handling VI, such as the Simple Error Handler.



**source** identifies the VI where the error occurred.

## Output



**ObjHandle out** is the object handle for the next NI-CAN VI.



**AttrValue** returns the attribute value specified by **AttrId**.



**Error out** describes error conditions. If the **Error in** cluster indicated an error, the **Error out** cluster contains the same information. Otherwise, **Error out** describes the error status of this VI.



**status** is True if an error occurred.



**code** is the error code number identifying an error. A value of 0 means success. A negative value means error: VI did not execute



the intended operation. A positive value means warning: VI executed intended operation, but an informational warning is returned. For a description of the **code**, wire the error cluster to a LabVIEW error-handling VI, such as the Simple Error Handler.



**source** identifies the VI where the error occurred.

## Description

**ncGetAttr.vi** gets the value of the attribute specified by **AttrId** from the object specified by **ObjHandle**. Within NI-CAN objects, you use attributes to access configuration settings, status, and other information about the object, but not data.

## ncGetHardwareInfo.vi

### Purpose

Get CAN or LIN hardware information.

### Format

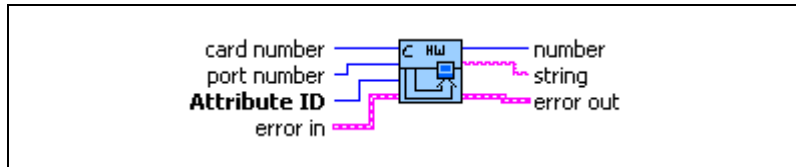

### Input



**card number** specifies the CAN or LIN card number from 1 to **Number of Cards**, where **Number of Cards** is the number of CAN and LIN cards in the system. You can determine the number of cards in the system by using this VI with **card number** = 1, **port number** = 1, and **attribute ID** = **Number of Cards**.



**port number** specifies the CAN or LIN port number from 1 to **Number of Ports**, where **Number of Ports** is the number of ports on this card. You can determine the number of ports on this card by using this VI with **port number** = 1, and **attribute ID** = **Number of Ports**.



**attribute ID** specifies the attribute to get.

#### Version Major

Returns the major version of the NI-CAN software in the **number** output. Use **card number** 1 and **port number** 1 as inputs.

The major version is the 'X' in X.Y.Z.

#### Version Minor

Returns the minor version of the NI-CAN software in the **number** output. Use **card number** 1 and **port number** 1 as inputs.

The minor version is the 'Y' in X.Y.Z.

#### Version Update

Returns the update version of the NI-CAN software in the **number** output. Use **card number** 1 and **port number** 1 as inputs.

The update version is the 'Z' in X.Y.Z.

**Version Phase**

Returns the phase of the NI-CAN software in the **number** output. Use **card number 1** and **port number 1** as inputs.

Phase 1 specifies Alpha, phase 2 specifies Beta, and phase 3 specifies Final release. Unless you are participating in an NI-CAN beta program, you will always see **3**.

**Version Build**

Returns the build of the NI-CAN software in the **number** output. Use **card number 1** and **port number 1** as inputs.

With each software development phase, subsequent NI-CAN builds are numbered sequentially. A given Final release version always uses the same build number, so unless you are participating in an NI-CAN beta program, this build number is not relevant.

**Version Comment**

Returns any special comment on the NI-CAN software in the **string** output. Use **card number 1** and **port number 1** as inputs.

This string is normally empty for a Final release. In rare circumstances, an NI-CAN prototype or patch may be released to a specific customer. For these special releases, the version comment describes the special features of the release.

**Number of Cards**

Returns the number of CAN and LIN cards in the system in the **number** output. Use **card number 1** and **port number 1** as inputs.

If you are displaying all hardware information, you get this attribute first, then iterate through all cards with a For loop. Inside the For loop, you get all card-wide attributes including **Number Of Ports**, then use another For loop to get port-wide attributes.

**Serial Number**

Card-wide attribute that returns the serial number of the card in the **number** output. Use the desired **card number**, and **port number 1** as inputs.

**Form Factor**

Card-wide attribute that returns the form factor of the card in the **number** output. Use the desired **card number**, and **port number 1** as inputs.

The returned Form Factor is an enumeration.

0	PCI
1	PXI
2	PCMCIA
3	AT
4	USB

### Series

Card-wide attribute that returns the series of the card in the **number** output. Use the desired **card number**, and **port number 1** as inputs.

Series 1 hardware products use the Intel 82527 CAN controller.

Series 2 hardware products use the Philips SJA1000 CAN controller, plus improved RTSI synchronization features.

The returned Series is an enumeration.

0	Series 1
1	Series 2
2	847x
3	847x with Sync
4	NI-XNET

### Number of Ports

Card-wide attribute that returns the number of ports on the card in the **number** output. Use the desired **card number**, and **port number 1** as inputs.

If you are displaying all hardware information, you get this attribute within the For loop for all cards, then iterate through all CAN ports to get port-wide attributes.

### Transceiver Type

This port-wide attribute returns the type of transceiver in the **number** output. Use the desired **card number** and **port number** as inputs.

For hardware other than Series 2 XS cards, the transceiver type is fixed. For Series 2 XS cards, the transceiver type reflects the most recent value specified by MAX or [ncSetAttr.vi](#).

This attribute is not supported on the PCMCIA form factor.

This attribute uses the following values:

**0** (High-Speed)

Transceiver type is High-Speed (HS).

**1** (Low-Speed/Fault-Tolerant)

Transceiver type is Low-Speed/Fault-Tolerant (LS).

**2** (Single Wire)

Transceiver type is Single Wire (SW).

**3** (External)

Transceiver type is External. This transceiver type is available on Series 2 XS cards only. For more information, refer to [ncSetAttr.vi](#).

**4** (Disconnect)

Transceiver type is Disconnect. This transceiver type is available on Series 2 XS cards only. For more information, refer to [ncSetAttr.vi](#).

**5** (LIN)

Transceiver type is **LIN**.

### Interface Number

Port-wide attribute that returns the interface number of the port in the **number** output. Use the desired **card number** and **port number** as inputs.

The interface number is assigned to a physical port using the Measurement and Automation Explorer (MAX). The interface number is used as a string in the Frame API (for example, “CAN0”). The interface number is used for the **interface** input in the Channel API.



**Error in** describes error conditions occurring before the VI executes. If an error has already occurred, the VI returns the value of the **Error in** cluster in **Error out**.



**status** is True if an error occurred. If **status** is True, the VI does not perform any operations.



**code** is the error code number identifying an error. A value of 0 means success. A negative value means error: VI did not execute the intended operation. A positive value means warning: VI executed intended operation, but an informational warning is returned. For a description of the **code**, wire the error cluster to a LabVIEW error-handling VI, such as the Simple Error Handler.



**source** identifies the VI where the error occurred.

## Output



If the attribute is a **number**, the value is returned in this output terminal.



If the attribute is a **string**, the value is returned in this output terminal.



**Error out** describes error conditions. If the **Error in** cluster indicated an error, the **Error out** cluster contains the same information. Otherwise, **Error out** describes the error status of this VI.



**status** is True if an error occurred.



**code** is the error code number identifying an error. A value of 0 means success. A negative value means error: VI did not execute the intended operation. A positive value means warning: VI executed intended operation, but an informational warning is returned. For a description of the **code**, wire the error cluster to a LabVIEW error-handling VI, such as the Simple Error Handler.



**source** identifies the VI where the error occurred.

## Description

This VI provides information about available CAN and LIN cards, but does not require you to open/start sessions. First get **Number of Cards**, then loop for each card. For each card, you can get card-wide attributes (such as **Form Factor**), and you also can get the **Number of Ports**. For each port, you can get port-wide attributes such as the **Transceiver**.

## ncGetTimer.vi

### Purpose

Get the absolute timestamp attribute.

### Format

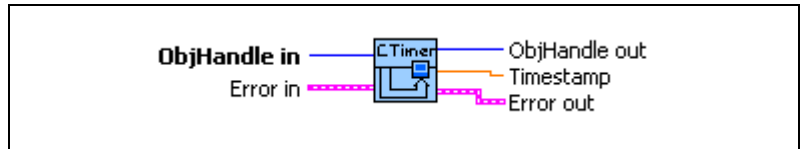

### Input



**ObjHandle in** is the object handle from the previous NI-CAN VI. The handle originates from **ncOpen.vi**.



**Error in** describes error conditions occurring before the VI executes. If an error has already occurred, the VI returns the value of the **Error in** cluster in **Error out**.



**status** is True if an error occurred. If **status** is True, the VI does not perform any operations.



**code** is the error code number identifying an error. A value of 0 means success. A negative value means error: VI did not execute the intended operation. A positive value means warning: VI executed intended operation, but an informational warning is returned. For a description of the **code**, wire the error cluster to a LabVIEW error-handling VI, such as the Simple Error Handler.



**source** identifies the VI where the error occurred.

### Output



**ObjHandle out** is the object handle for the next NI-CAN VI.



**Timestamp** returns the absolute timestamp value. The value matches the absolute timestamp format used within LabVIEW itself. LabVIEW time is a DBL representing the number of seconds elapsed since 12:00 a.m., Friday, January 1, 1904, Coordinated Universal Time (UTC). You can wire this **Timestamp** to LabVIEW time functions such as **Seconds To Date/Time**. You also can display the time in a numeric indicator of type DBL by using **Format & Precision** to select **Time & Date** format.



**Note** If you use **Time & Date** format, LabVIEW limits the **Seconds Precision** to 3, which shows only milliseconds. The NI-CAN timestamp provides microsecond precision. If you need to view microsecond precision, change the timestamp to decimal format, with six digits of precision.



**Error out** describes error conditions. If the **Error in** cluster indicated an error, the **Error out** cluster contains the same information. Otherwise, **Error out** describes the error status of this VI.



**status** is True if an error occurred.



**code** is the error code number identifying an error. A value of 0 means success. A negative value means error: VI did not execute the intended operation. A positive value means warning: VI executed intended operation, but an informational warning is returned. For a description of the **code**, wire the error cluster to a LabVIEW error-handling VI, such as the Simple Error Handler.



**source** identifies the VI where the error occurred.

## Description

This VI can be used only with the CAN or LIN Network Interface, and not with CAN Objects.



## ncOpen.vi

### Purpose

Open an object.

### Format

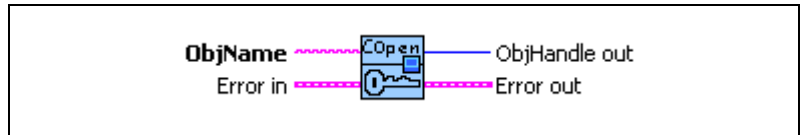

### Input



**ObjName** is the name of the object to open. For CAN interfaces, you must have already wired this name into a previous config VI.

#### CAN Network Interface Object

This name uses the syntax “CAN $x$ ”, where  $x$  is a decimal number starting at zero that indicates the CAN network interface (CAN0, CAN1, up to CAN63). CAN network interface names are associated with physical CAN ports using the Measurement and Automation Explorer (MAX).

The special interface values 256 and 257 refer to virtual interfaces. For more information on usage of virtual interfaces, refer to the [Frame to Channel Conversion](#) section of Chapter 6, *Using the Channel API*.

#### LIN Network Interface Object

This name uses the syntax LIN $x$ , where  $x$  is a decimal number starting at zero that indicates the LIN network interface (LIN0, LIN1, up to LIN63), where CAN and LIN share the same range. LIN network interface names are associated with physical LIN ports using the Measurement and Automation Explorer (MAX).

#### CAN Object

This name uses the syntax “CAN $x$ ::STD $y$ ” or “CAN $x$ ::XTD $y$ ”. CAN $x$  is the name of the CAN network interface that you used for the preceding [ncConfigCANNET.vi](#). STD indicates that the CAN Object uses a standard (11-bit) arbitration ID. XTD indicates that the CAN Object uses an extended (29-bit) arbitration ID. The number  $y$  specifies the actual arbitration ID of the CAN Object. The number  $y$  is decimal by default, but you also can use hexadecimal by adding **0x** to the beginning of the number.

For example, “CAN0::STD25” indicates standard ID 25 decimal on CAN0, and “CAN1::XTD0x0000F652” indicates extended ID F652 hexadecimal on CAN1.

The special virtual interface names “CAN256” and “CAN257” are not supported for CAN Objects.



**Error in** describes error conditions occurring before the VI executes. If an error has already occurred, the VI returns the value of the **Error in** cluster in **Error out**.



**status** is True if an error occurred. If **status** is True, the VI does not perform any operations.



**code** is the error code number identifying an error. A value of 0 means success. A negative value means error: VI did not execute the intended operation. A positive value means warning: VI executed intended operation, but an informational warning is returned. For a description of the **code**, wire the error cluster to a LabVIEW error-handling VI, such as the Simple Error Handler.



**source** identifies the VI where the error occurred.

## Output



**ObjHandle out** is the object handle for all subsequent NI-CAN VIs for this object, including the final call to **ncClose.vi**.



**Error out** describes error conditions. If the **Error in** cluster indicated an error, the **Error out** cluster contains the same information. Otherwise, **Error out** describes the error status of this VI.



**status** is True if an error occurred.



**code** is the error code number identifying an error. A value of 0 means success. A negative value means error: VI did not execute the intended operation. A positive value means warning: VI executed intended operation, but an informational warning is returned. For a description of the **code**, wire the error cluster to a LabVIEW error-handling VI, such as the Simple Error Handler.



**source** identifies the VI where the error occurred.

## Description

**ncOpen.vi** takes the name of an object to open and returns a handle to that object that you use with subsequent NI-CAN function calls.

The Frame API and Channel API cannot use the same CAN network interface simultaneously. If the CAN network interface is already initialized in the Channel API, this function returns an error.

If **ncOpen.vi** is successful, a handle to the newly opened object is returned. You use this object handle for all subsequent function calls for the object.

## ncReadNet.vi

### Purpose

Read single frame from a CAN or LIN Network Interface Object.

### Format

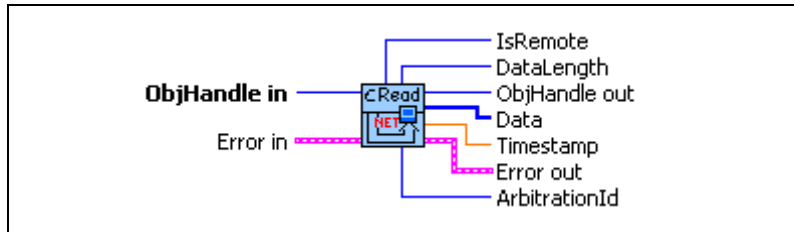

### Input



**ObjHandle in** is the object handle from the previous NI-CAN VI. The handle originates from **ncOpen.vi**.



**Error in** describes error conditions occurring before the VI executes. If an error has already occurred, the VI returns the value of the **Error in** cluster in **Error out**.



**status** is True if an error occurred. If **status** is True, the VI does not perform any operations.



**code** is the error code number identifying an error. A value of 0 means success. A negative value means error: VI did not execute the intended operation. A positive value means warning: VI executed intended operation, but an informational warning is returned. For a description of the **code**, wire the error cluster to a LabVIEW error-handling VI, such as the Simple Error Handler.



**source** identifies the VI where the error occurred.

### Output



**ObjHandle out** is the object handle for the next NI-CAN VI.



**Note** The description of the output terminals is specified by the frame type. The value of **IsRemote** indicates the frame type. For a description of each frame type, refer to the [Frame Types](#) section in this function reference.



**Error out** describes error conditions. If the **Error in** cluster indicated an error, the **Error out** cluster contains the same information. Otherwise, **Error out** describes the error status of this VI.



**status** is True if an error occurred.



**code** is the error code number identifying an error. A value of 0 means success. A negative value means error: VI did not execute the intended operation. A positive value means warning: VI executed intended operation, but an informational warning is returned. For a description of the **code**, wire the error cluster to a LabVIEW error-handling VI, such as the Simple Error Handler.



**source** identifies the VI where the error occurred.

## Description

The **ncReadNet.vi** VI is useful when you need to process one frame at a time, because it returns separate outputs for **ArbitrationId**, **Timestamp**, and so on. In order to read multiple frames at a time, such as for high-bandwidth networks, use **ncReadNetMult.vi**.

Since NI-CAN handles the read queue in the background, this VI does not wait for new frames to arrive. To ensure that a new frame is available before calling **ncReadNet.vi**, first wait for the Read Available state using **ncWaitForState.vi**.

When you call **ncReadNet.vi** for an empty read queue (Read Available state false), the frame from the previous call to **ncReadNet.vi** is returned again, along with the **CanWarnOldData** warning (**status=F**, **code=3FF62009 hex**).

When a frame arrives for a full read queue, NI-CAN discards the new frame, and the next call to **ncReadNet.vi** returns the error **CanErrOverflowRead** (**status=T**, **code= BFF62028 hex**). If you detect this overflow, switch to using **ncReadNetMult.vi** to read in a relatively tight loop (few milliseconds each read).

Although the Network Interface allows **Read Queue Length** of zero, this is not recommended, because every new frame will always overwrite the previous frame.

You can use the Network Interface and CAN Objects simultaneously. When a CAN frame arrives from the network, NI-CAN first checks the **ArbitrationId** for an open CAN Object. If no CAN Object applies, NI-CAN checks the comparators and masks of the Network Interface (including the Series 2 Filter Mode attributes). If the frame passes that filter, NI-CAN places the frame into the read queue of the Network Interface.

## Error Active, Error Passive, and Bus Off States

When the CAN communication controller transfers into the error passive state, NI-CAN returns the warning **CanCommWarning** (**Status=F**, **code=3ff6200B hex**) from read VIs.

When the transmit error counter of the CAN communication controller increments above 255, the network interface transfers into the bus off state as dictated by the CAN protocol. The network interface stops communication so that you can correct the defect in the network, such as a malfunctioning cable or device. When bus off occurs, NI-CAN returns the error **CanCommError** (**status=T**, **code=BFF6200B hex**) from read VIs.

If no CAN devices are connected to the network interface port, and you attempt to transmit a frame, the **CanWarnComm** warning is returned. This warning occurs because the missing acknowledgment bit increments the transmit error counter until the network interface reaches the error passive state, but bus off state is never reached.





For more information about low-speed communication error handling, refer to the **Log Comm Warnings** attribute in [ncSetAttr.vi](#).

## Frame Types





**IsRemote** indicates the frame type. The frame type determines the interpretation of the remaining fields. Table 10-11, *IsRemote Value 0: CAN Data Frame*, Table 10-12, *IsRemote Value 1: CAN Remote Frame*, Table 10-13, *IsRemote Value 2: Communication Warning or Error Frame*, Table 10-14, *IsRemote Value 3: RTSI Frame*, Table 10-15, *IsRemote Value 4: Start Trigger Frame*, Table 10-16, *IsRemote Value 6: CAN Bus Error Frame*, Table 10-17, *IsRemote Value 7: Transceiver Fault Frame*, Table 10-18, *IsRemote Value 18: LIN Full Frame*, Table 10-19, *IsRemote Value 19: LIN Wakeup Received Frame*, Table 10-20, *IsRemote Value 20: LIN Bus Inactive Frame*, and Table 10-21, *IsRemote Value 21: LIN Bus Error Frame*, describe the fields of the cluster for each value of **IsRemote**.

To determine if your hardware supports one of the following frame types for this function, refer to Appendix D, *Frame Types for CAN and LIN Hardware*.





**Table 10-11.** IsRemote Value 0: CAN Data Frame

Field Name	Data Type	Description
IsRemote		Value <b>0</b> represents a CAN data frame. The CAN data frame contains data from the network.
ArbitrationId		Specifies the arbitration ID to transmit in the CAN data frame. A standard ID (11-bit) is specified by default.
DataLength		Indicates the number of data bytes in the <b>Data</b> array.
Data		The received data bytes (8 maximum).

**Table 10-12.** IsRemote Value 1: CAN Remote Frame





Field Name	Data Type	Description
IsRemote		<p>Value <b>1</b> represents a CAN remote frame.</p> <p>Only Series 2, 847x CAN, or 847x with Sync CAN interfaces can receive remote frames using the Network Interface. For Series 1 hardware, you must handle incoming remote frames with CAN Object only.</p>
ArbitrationId		Specifies the arbitration ID to transmit in the CAN data frame.
DataLength		Returns the Data Length Code in the remote frame, but with no data.
Data		Ignored. No data bytes are contained in a CAN remote frame.

**Table 10-13.** IsRemote Value 2: Communication Warning or Error Frame



Field Name	Data Type	Description
IsRemote		Value <b>2</b> represents a communication warning or error frame.  This indicates a communication problem reported by the CAN controller or the low-speed CAN transceiver. This frame type occurs only when you set the <b>Log Comm Warnings</b> attribute to TRUE and the CAN controller is in the error passive state. For more information on communication problems, refer to the <i>Description</i> section of this function reference.
ArbitrationId		<b>8000000B</b> hex—Comm. error: General <b>4000000B</b> hex—Comm. warning: General <b>8001000B</b> hex—Comm. error: Stuffing <b>4001000B</b> hex—Comm. warning: Stuffing <b>8002000B</b> hex—Comm. error: Format <b>4002000B</b> hex—Comm. warning: Format <b>8003000B</b> hex—Comm. error: No Ack <b>4003000B</b> hex—Comm. warning: No Ack <b>8004000B</b> hex—Comm. error: Tx 1 Rx 0 <b>4004000B</b> hex—Comm. warning: Tx 1 Rx 0 <b>8005000B</b> hex—Comm. error: Tx 0 Rx 1 <b>4005000B</b> hex—Comm. warning: Tx 0 Rx 1 <b>8006000B</b> hex—Comm. error: Bad CRC <b>4006000B</b> hex—Comm. warning: Bad CRC <b>0000000B</b> hex—Comm. Error/warnings cleared <b>8000000C</b> hex—Transceiver fault warning <b>0000000C</b> hex—Transceiver fault cleared
DataLength		Ignored.
Data		Ignored.





**Table 10-14.** IsRemote Value 3: RTSI Frame

Field Name	Data Type	Description
IsRemote		Value <b>3</b> represents a RTSI frame.  This indicates when a RTSI input pulse occurred relative to incoming CAN frames. This frame type occurs only when you set the <b>RTSI Mode</b> attribute to <b>On RTSI Input–Timestamp</b> event (refer to <a href="#">ncConfigCANNetRTSI.vi</a> for details).
ArbitrationId		Is the special value <b>40000001</b> hex.
DataLength		The RTSI signal detected.
Data		Ignored.



**Table 10-15.** IsRemote Value 4: Start Trigger Frame

Field Name	Data Type	Description
IsRemote		Value <b>4</b> represents the start trigger frame.  When the <b>Log Start Trigger?</b> attribute is enabled, this frame indicates the time when the start trigger occurs. For example, if you use <a href="#">ncConnectTerminals.vi</a> to connect a RTSI input to the start trigger, this frame occurs when the RTSI input pulses for the first time. Another use case for logging the start trigger would be for logging the received CAN frames in a file. This ensures that the first frame in a logfile is a start trigger frame, which specifies the absolute time (date/time) at which CAN communication started.
ArbitrationId		Zero.
DataLength		One.



**Table 10-15.** IsRemote Value 4: Start Trigger Frame (Continued)

Field Name	Data Type	Description
Data		The <b>Data</b> array contains a single byte that specifies the timestamp format used for all the subsequent frames. The value is 0 for absolute timestamps, and 1 for relative timestamps.
Timestamp		This indicates the time of the start trigger in the absolute format. Within a logfile, this timestamp indicates the date and time at which communication started.  The timestamp is a LabVIEW numeric double with <b>Format and Precision</b> of <b>Absolute</b> time (date/time). The format of this timestamp is always absolute, even when <b>Data</b> byte 0 specifies relative timestamp format. This absolute timestamp provides date/time information even when the frames use the relative format.



**Table 10-16.** IsRemote Value 6: CAN Bus Error Frame

Field Name	Data Type	Description
IsRemote		Value <b>6</b> represents a CAN bus error frame. Refer to the <b>Log Bus Errors?</b> attribute description for more information on CAN Bus Error frames.
ArbitrationId		Zero.
DataLength		Four.

**Table 10-16.** IsRemote Value 6: CAN Bus Error Frame (Continued)

Field Name	Data Type	Description
Data		<p>0—Comm State (See description below)</p> <p>1—Transmit Error Counter</p> <p>2—Receive Error Counter</p> <p>3—ECC Register</p> <p>4—X</p> <p>5—X</p> <p>6—X</p> <p>7—X</p> <p><b>Note:</b> X means <i>Reserved</i> or <i>Don't Care</i>.</p> <p>The first data byte (Comm State) indicates the current communication state of the CAN controller. The states are:</p> <p>0—Error Active</p> <p>1—Error Passive</p> <p>2—Bus Off</p>
Timestamp		Time when the bus error was detected.

**Table 10-17.** IsRemote Value 7: Transceiver Fault Frame

Field Name	Data Type	Description
IsRemote		Value 7 represents a transceiver fault frame. Refer to the <a href="#">Log Transceiver Faults?</a> attribute description for more information on Transceiver Fault frames.
ArbitrationId		Zero.
DataLength		One.





**Table 10-17.** IsRemote Value 7: Transceiver Fault Frame (Continued)

Field Name	Data Type	Description
Data	[U8]	0—Transceiver fault (0=fault cleared, 1=fault present) 1—X 2—X 3—X 4—X 5—X 6—X 7—X
Timestamp	DBL	Time when the transceiver fault was detected.





**Table 10-18.** IsRemote Value 18: LIN Full Frame

Field Name	Data Type	Description
IsRemote	[U8]	Value <b>18</b> represents a full frame for LIN communication. A full frame is reported when the LIN interface slave task has received one complete LIN frame. All frames for which the LIN interface slave task is a subscriber will be reported. Frames for which the LIN interface slave task is a publisher will be reported only if the <b>Self Reception</b> attribute is set to TRUE.
ArbitrationId	[U32]	Zero to sixty-three.
DataLength	[U8]	One to eight.
Data	[U8]	LIN frame data.
Timestamp	DBL	Time at point of reception of LIN frame checksum.





**Table 10-19.** IsRemote Value 19: LIN Wakeup Received Frame

Field Name	Data Type	Description
IsRemote		Value <b>19</b> represents a wakeup received frame for LIN communication. A wakeup received frame is reported when the LIN interface is asleep, the <b>LIN Log Wakeup</b> attribute is set to TRUE, and a wakeup event is detected.
ArbitrationId		Zero.
DataLength		Zero.
Data		Ignored.
Timestamp		Time at point of wakeup event detection.

**Table 10-20.** IsRemote Value 20: LIN Bus Inactive Frame

Field Name	Data Type	Description
IsRemote		Value <b>20</b> represents a bus inactive frame for LIN communication. Bus inactive detection begins when the LIN interface senses the first activity on the bus. When activity ceases, a bus inactive frame is reported if the inactivity lasts for more than four seconds.
ArbitrationId		Zero.
DataLength		Zero.
Data		Ignored.
Timestamp		Time at point of four second timeout.

**Table 10-21.** IsRemote Value 21: LIN Bus Error Frame

Field Name	Data Type	Description
IsRemote		Value <b>21</b> represents a LIN bus error frame for LIN communication. A LIN bus error frame is reported when the <b>Log Bus Errors?</b> attribute is set to TRUE, and a bus error occurs.
ArbitrationId		Zero.
DataLength		Varies depending on the error. Refer to Table 10-33, <i>LIN Bus Error Codes and Descriptions</i> , in <b>ncSetAttr.vi</b> for information.
Data		Error frame information.
Timestamp		Time at point of bus error detection.



**Note** If you use **Time & Date** format, LabVIEW limits the **Seconds Precision** to 3, which shows only milliseconds. The NI-CAN timestamp provides microsecond precision. If you need to view microsecond precision, change the timestamp to decimal format, with six digits of precision.

## ncReadNetMult.vi

### Purpose

Read multiple frames from a CAN or LIN Network Interface Object.

### Format

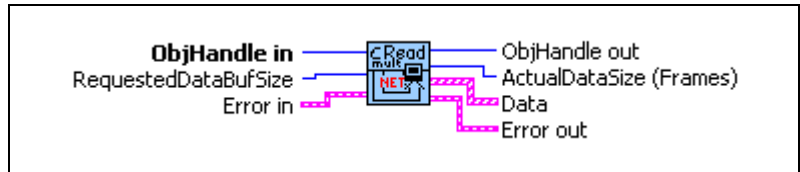

### Input



**ObjHandle in** is the object handle from the previous NI-CAN VI. The handle originates from **ncOpen.vi**.



**RequestedDataBufSize** specifies the maximum number of frames desired. To empty the read queue, call **ncGetAttr.vi** for the **Read Entries Pending** attribute to get the actual number of frames in the read queue and use that number as the **RequestedDataBufSize**.



**Error in** describes error conditions occurring before the VI executes. If an error has already occurred, the VI returns the value of the **Error in** cluster in **Error out**.



**status** is True if an error occurred. If **status** is True, the VI does not perform any operations.



**code** is the error code number identifying an error. A value of 0 means success. A negative value means error: VI did not execute the intended operation. A positive value means warning: VI executed intended operation, but an informational warning is returned. For a description of the **code**, wire the error cluster to a LabVIEW error-handling VI, such as the Simple Error Handler.



**source** identifies the VI where the error occurred.

### Output



**ObjHandle out** is the object handle for the next NI-CAN VI.



**ActualDataSize (Frames)** specifies the number of frames returned in **Data**. This number is less than or equal to **RequestedDataBufSize**.



**Data** returns an array of clusters. Each cluster in the array uses the typedef **CanFrameTimed.ctl**, with the following elements.



**Note** Within each cluster, **IsRemote** indicates the frame type. The frame type determines the interpretation of the remaining fields. For a description of each frame type, refer to the *Frame Types* section of this function reference.



**Error out** describes error conditions. If the **Error in** cluster indicated an error, the **Error out** cluster contains the same information. Otherwise, **Error out** describes the error status of this VI.



**status** is True if an error occurred.



**code** is the error code number identifying an error. A value of 0 means success. A negative value means error: VI did not execute the intended operation. A positive value means warning: VI executed intended operation, but an informational warning is returned. For a description of the **code**, wire the error cluster to a LabVIEW error-handling VI, such as the Simple Error Handler.



**source** identifies the VI where the error occurred.

## Description

Since NI-CAN handles the read queue in the background, this VI does not wait for new frames to arrive. To ensure that new frames are available before calling **ncReadNetMult.vi**, first wait for the Read Available state or Read Multiple state using **ncWaitForState.vi**.

When you call **ncReadNetMult.vi** for an empty read queue (Read Available state false), **Error out** returns **success** (status=F, code=0), and **ActualDataSize (Frames)** returns 0.

When a frame arrives for a full read queue, NI-CAN discards the new frame, and the next call to **ncReadNetMult.vi** returns the error **CanErrOverflowRead** (status=T, code= BFF62028 hex). If you detect this overflow, try to read in a relatively tight loop (few milliseconds each read).

Although the Network Interface allows **Read Queue Length** of zero, this is not recommended, because every new frame will always overwrite the previous frame.

You can use the Network Interface and CAN Objects simultaneously. When a CAN frame arrives from the network, NI-CAN first checks the ArbitrationId for an open CAN Object. If no CAN Object applies, NI-CAN checks the comparators and masks of the Network Interface (including the Series 2 Filter Mode attributes). If the frame passes that filter, NI-CAN places the frame into the read queue of the Network Interface.



## Error Active, Error Passive, and Bus Off States

When the CAN communication controller transfers into the error passive state, NI-CAN returns the warning **CanCommWarning** (Status=F, code=3ff6200B hex) from read VIs.

When the transmit error counter of the CAN communication controller increments above 255, the network interface transfers into the bus off state as dictated by the CAN protocol. The network interface stops communication so that you can correct the defect in the network, such as a malfunctioning cable or device. When bus off occurs, NI-CAN returns the error **CanCommError** (status=T, code=BFF6200B hex) from read VIs.

If no CAN devices are connected to the network interface port, and you attempt to transmit a frame, the warning **CanWarnComm** is returned. This warning occurs because the missing acknowledgment bit increments the transmit error counter until the network interface reaches the error passive state, but bus off state is never reached.



For more information about low-speed communication error handling, refer to the **Log Comm Warnings** attribute in [ncSetAttr.vi](#).

## Frame Types



**IsRemote** indicates the frame type. The frame type determines the interpretation of the remaining fields. Table 10-22, *IsRemote Value 0: CAN Data Frame*, Table 10-23, *IsRemote Value 1: CAN Remote Frame*, Table 10-24, *IsRemote Value 2: Communication Warning or Error Frame*, Table 10-25, *IsRemote Value 3: RTSI Frame*, Table 10-26, *IsRemote Value 4: Start Trigger Frame*, Table 10-27, *IsRemote Value 6: CAN Bus Error Frame*, Table 10-28, *IsRemote Value 7: Transceiver Fault Frame*, Table 10-29, *IsRemote Value 18: LIN Full Frame*, Table 10-30, *IsRemote Value 19: LIN Wakeup Received Frame*, Table 10-31, *IsRemote Value 20: LIN Bus Inactive Frame*, and Table 10-32, *IsRemote Value 21: LIN Bus Error Frame*, describe the fields of the cluster for each value of **IsRemote**.

To determine if your hardware supports one of the following frame types for this function, refer to Appendix D, *Frame Types for CAN and LIN Hardware*.





**Table 10-22.** IsRemote Value 0: CAN Data Frame

Field Name	Data Type	Description
IsRemote		Value <b>0</b> represents a CAN data frame. The CAN data frame contains data from the network.
ArbitrationId		Specifies the arbitration ID to transmit in the CAN data frame. A standard ID (11-bit) is specified by default.

**Table 10-22.** IsRemote Value 0: CAN Data Frame (Continued)

Field Name	Data Type	Description
DataLength		Indicates the number of data bytes in the <b>Data</b> array.
Data		The received data bytes (8 maximum).





**Table 10-23.** IsRemote Value 1: CAN Remote Frame

Field Name	Data Type	Description
IsRemote		Value <b>1</b> represents a CAN remote frame. Only Series 2 or later can receive remote frames using the Network Interface. For Series 1 hardware, you must handle incoming remote frames with CAN Object only.
ArbitrationId		Specifies the arbitration ID to transmit in the CAN data frame.
DataLength		Returns the Data Length Code in the remote frame, but with no data.
Data		Ignored. No data bytes are contained in a CAN remote frame.



**Table 10-24.** IsRemote Value 2: Communication Warning or Error Frame

Field Name	Data Type	Description
IsRemote	<b>U32</b>	<p>Value <b>2</b> represents a communication warning or error frame.</p> <p>This indicates a communication problem reported by the CAN controller or the low-speed CAN transceiver. This frame type occurs only when you set the <b>Log Comm Warnings</b> attribute to TRUE and the CAN controller is in the error passive state. For more information on communication problems, refer to the <i>Description</i> section of this function reference.</p>
ArbitrationId	<b>U32</b>	<p><b>8000000B</b> hex—Comm. error: General</p> <p><b>4000000B</b> hex—Comm. warning: General</p> <p><b>8001000B</b> hex—Comm. error: Stuffing</p> <p><b>4001000B</b> hex—Comm. warning: Stuffing</p> <p><b>8002000B</b> hex—Comm. error: Format</p> <p><b>4002000B</b> hex—Comm. warning: Format</p> <p><b>8003000B</b> hex—Comm. error: No Ack</p> <p><b>4003000B</b> hex—Comm. warning: No Ack</p> <p><b>8004000B</b> hex—Comm. error: Tx 1 Rx 0</p> <p><b>4004000B</b> hex—Comm. warning: Tx 1 Rx 0</p> <p><b>8005000B</b> hex—Comm. error: Tx 0 Rx 1</p> <p><b>4005000B</b> hex—Comm. warning: Tx 0 Rx 1</p> <p><b>8006000B</b> hex—Comm. error: Bad CRC</p> <p><b>4006000B</b> hex—Comm. warning: Bad CRC</p> <p><b>0000000B</b> hex—Comm. Error/warnings cleared</p> <p><b>8000000C</b> hex—Transceiver fault warning</p> <p><b>0000000C</b> hex—Transceiver fault cleared</p>
DataLength	<b>U32</b>	Ignored.
Data	<b>[U8]</b>	Ignored.



**Table 10-25.** IsRemote Value 3: RTSI Frame

Field Name	Data Type	Description
IsRemote		Value <b>3</b> represents a RTSI frame.  This indicates when a RTSI input pulse occurred relative to incoming frames. This frame type occurs only when you set the <b>RTSI Mode</b> attribute to <b>On RTSI Input–Timestamp</b> event (refer to <b>ncConfigCANNetRTSI.vi</b> for details).
ArbitrationId		Is the special value <b>40000001</b> hex.
DataLength		The RTSI signal detected.
Data		Ignored.



**Table 10-26.** IsRemote Value 4: Start Trigger Frame

Field Name	Data Type	Description
IsRemote		Value <b>4</b> represents the start trigger frame.  When the <b>Log Start Trigger?</b> attribute is enabled, this frame indicates the time when the start trigger occurs. For example, if you use <b>ncConnectTerminals.vi</b> to connect a RTSI input to the start trigger, this frame occurs when the RTSI input pulses for the first time. Another use case for logging the start trigger would be for logging the received CAN frames in a file. This ensures that the first frame in a logfile is a start trigger frame, which specifies the absolute time (date/time) at which CAN communication started.
ArbitrationId		Zero.
DataLength		One.



**Table 10-26.** IsRemote Value 4: Start Trigger Frame (Continued)

Field Name	Data Type	Description
Data		The <b>Data</b> array contains a single byte that specifies the timestamp format used for all the subsequent CAN frames. The value is 0 for absolute timestamps, and 1 for relative timestamps.
Timestamp		This indicates the time of the start trigger in the absolute format. Within a logfile, this timestamp indicates the date and time at which communication started.  The timestamp is a LabVIEW numeric double with <b>Format and Precision</b> of <b>Absolute</b> time (date/time). The format of this timestamp is always absolute, even when <b>Data</b> byte 0 specifies relative timestamp format. This absolute timestamp provides date/time information even when the CAN frames use the relative format.



**Table 10-27.** IsRemote Value 6: CAN Bus Error Frame

Field Name	Data Type	Description
IsRemote		Value <b>6</b> represents a CAN bus error frame. Refer to the <b>Log Bus Errors?</b> attribute description for more information on CAN Bus Error frames.
ArbitrationId		Zero.
DataLength		Four.

**Table 10-27.** IsRemote Value 6: CAN Bus Error Frame (Continued)

Field Name	Data Type	Description
Data		<p>0—Comm State (See description below)</p> <p>1—Transmit Error Counter</p> <p>2—Receive Error Counter</p> <p>3—ECC Register</p> <p>4—X</p> <p>5—X</p> <p>6—X</p> <p>7—X</p> <p><b>Note:</b> X means <i>Reserved</i> or <i>Don't Care</i>.</p> <p>The first data byte (Comm State) indicates the current communication state of the CAN controller. The states are:</p> <p>0—Error Active</p> <p>1—Error Passive</p> <p>2—Bus Off</p>
Timestamp		Time when the bus error was detected.

**Table 10-28.** IsRemote Value 7: Transceiver Fault Frame

Field Name	Data Type	Description
IsRemote		Value 7 represents a transceiver fault frame. Refer to the <b>Log Transceiver Faults?</b> attribute description for more information on Transceiver Fault frames.
ArbitrationId		Zero.
DataLength		One.





**Table 10-28.** IsRemote Value 7: Transceiver Fault Frame (Continued)

Field Name	Data Type	Description
Data	[U8]	0—Transceiver fault (0=fault cleared, 1=fault present) 1—X 2—X 3—X 4—X 5—X 6—X 7—X
Timestamp	DBL	Time when the transceiver fault was detected.





**Table 10-29.** IsRemote Value 18: LIN Full Frame

Field Name	Data Type	Description
IsRemote	[U8]	Value <b>18</b> represents a full frame for LIN communication. A full frame is reported when the LIN interface slave task has received one complete LIN frame. All frames for which the LIN interface slave task is a subscriber will be reported. Frames for which the LIN interface slave task is a publisher will be reported only if the <b>Self Reception</b> attribute is set to TRUE.
ArbitrationId	[U32]	Zero to sixty-three.
DataLength	[U8]	One to eight.
Data	[U8]	LIN frame data.
Timestamp	DBL	Time at point of reception of LIN frame checksum.

**Table 10-30.** IsRemote Value 19: LIN Wakeup Received Frame





Field Name	Data Type	Description
IsRemote		Value <b>19</b> represents a wakeup received frame for LIN communication. A wakeup received frame is reported when the LIN interface is asleep, the <b>LIN Log Wakeup</b> attribute is set to TRUE, and a wakeup event is detected.
ArbitrationId		Zero.
DataLength		Zero.
Data		Ignored.
Timestamp		Time at point of wakeup event detection.

**Table 10-31.** IsRemote Value 20: LIN Bus Inactive Frame

Field Name	Data Type	Description
IsRemote		Value <b>20</b> represents a bus inactive frame for LIN communication. Bus inactive detection begins when the LIN interface senses the first activity on the bus. When activity ceases, a bus inactive frame is reported if the inactivity lasts for more than four seconds.
ArbitrationId		Zero.
DataLength		Zero.
Data		Ignored.
Timestamp		Time at point of four second timeout.



**Table 10-32.** IsRemote Value 21: LIN Bus Error Frame

Field Name	Data Type	Description
IsRemote		Value <b>21</b> represents a LIN bus error frame for LIN communication. A LIN bus error frame is reported when the <b>Log Bus Errors?</b> attribute is set to TRUE, and a bus error occurs.
ArbitrationId		Zero.
DataLength		Varies depending on the error. Refer to Table 10-33, <i>LIN Bus Error Codes and Descriptions</i> , in <a href="#">ncSetAttr.vi</a> for information.
Data		Error frame information.
Timestamp		Time at point of bus error detection.



**Note** If you use **Time & Date** format, LabVIEW limits the **Seconds Precision** to 3, which shows only milliseconds. The NI-CAN timestamp provides microsecond precision. If you need to view microsecond precision, change the timestamp to decimal format, with six digits of precision.

## ncReadObj.vi

### Purpose

Read single frame from a CAN Object.

### Format

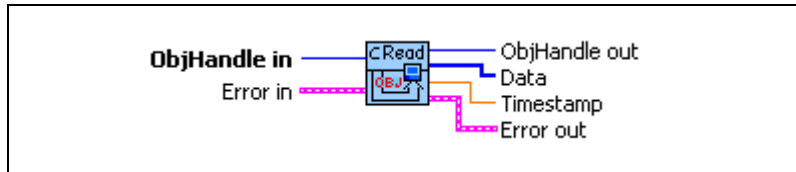

### Input



**ObjHandle in** is the object handle from the previous NI-CAN VI. The handle originates from [ncOpen.vi](#).



**Error in** describes error conditions occurring before the VI executes. If an error has already occurred, the VI returns the value of the **Error in** cluster in **Error out**.



**status** is True if an error occurred. If **status** is True, the VI does not perform any operations.



**code** is the error code number identifying an error. A value of 0 means success. A negative value means error: VI did not execute the intended operation. A positive value means warning: VI executed intended operation, but an informational warning is returned. For a description of the **code**, wire the error cluster to a LabVIEW error-handling VI, such as the Simple Error Handler.



**source** identifies the VI where the error occurred.

### Output



**ObjHandle out** is the object handle for the next NI-CAN VI.



**Data** array returns 8 data bytes. The actual number of valid data bytes depends on the CAN Object configuration specified in [ncConfigCANObj.vi](#).

If the CAN Object **Communication Type** specifies Transmit, data frames are transmitted, not received, so the [ncReadObj.vi](#) VI has no effect.

If the CAN Object **Communication Type** specifies Receive, **Data** always contains **Data Length** valid bytes, where **Data Length** was configured using **ncConfigCANObj.vi**.



**Timestamp** returns the absolute timestamp when the frame was placed into the read queue. The value matches the absolute timestamp format used within LabVIEW itself. LabVIEW time is a DBL representing the number of seconds elapsed since 12:00 a.m., Friday, January 1, 1904, Coordinated Universal Time (UTC). You can wire this **Timestamp** to LabVIEW time functions such as **Seconds To Date/Time**. You also can display the time in a numeric indicator of type DBL by using **Format & Precision** to select **Time & Date** format.



**Note** If you use **Time & Date** format, LabVIEW limits the **Seconds Precision** to 3, which shows only milliseconds. The NI-CAN timestamp provides microsecond precision. If you need to view microsecond precision, change the timestamp to decimal format, with six digits of precision.



**Error out** describes error conditions. If the **Error in** cluster indicated an error, the **Error out** cluster contains the same information. Otherwise, **Error out** describes the error status of this VI.



**status** is True if an error occurred.



**code** is the error code number identifying an error. A value of 0 means success. A negative value means error: VI did not execute the intended operation. A positive value means warning: VI executed intended operation, but an informational warning is returned. For a description of the **code**, wire the error cluster to a LabVIEW error-handling VI, such as the Simple Error Handler.



**source** identifies the VI where the error occurred.

## Description

**ncReadObj.vi** is useful when you need to process one frame at a time. In order to read multiple frames at a time, such as for high-bandwidth networks, use **ncReadObjMult.vi**.

Since NI-CAN handles the read queue in the background, this VI does not wait for a new frame to arrive. To ensure that a new frame is available before calling **ncReadObj.vi**, first wait for the Read Available state using **ncWaitForState.vi**.

When you call **ncReadObj.vi** for an empty read queue (Read Available state false), the frame from the previous call to **ncReadObj.vi** is returned again, along with the warning **CanWarnOldData** (**status=F**, **code=3FF62009 hex**).

When a frame arrives for a full read queue, NI-CAN discards the new frame, and the next call to **ncReadObj.vi** returns the error **CanErrOverflowRead** (status=T, code= BFF62028 hex). If you detect this overflow, switch to using **ncReadObjMult.vi** to read in a relatively tight loop (few milliseconds each read).

If you only need to obtain the most recent frame received for the CAN Object, you can set **Read Queue Length** to zero. When the read queue uses a zero length, only the most recent frame is stored, and overflow errors do not occur.

You can use the Network Interface and CAN Objects simultaneously. When a CAN frame arrives from the network, NI-CAN first checks the **ArbitrationId** for an open CAN Object. If no CAN Object applies, NI-CAN checks the comparators and masks of the Network Interface (including the Series 2 Filter Mode attributes). If the frame passes that filter, NI-CAN places the frame into the read queue of the Network Interface.

## ncReadObjMult.vi

### Purpose

Read multiple frames from a CAN Object.

### Format

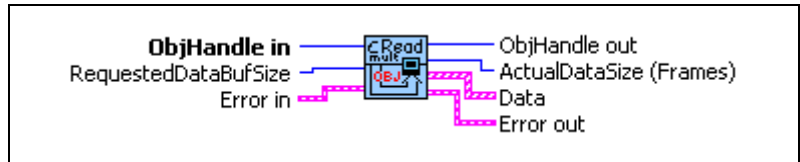

### Input



**ObjHandle in** is the object handle from the previous NI-CAN VI. The handle originates from [ncOpen.vi](#).



**RequestedDataBufSize** specifies the maximum number of frames desired. For most applications, this will be the same as the configured **Read Queue Length** in order to empty the read queue with each call to [ncReadObjMult.vi](#).



**Error in** describes error conditions occurring before the VI executes. If an error has already occurred, the VI returns the value of the **Error in** cluster in **Error out**.



**status** is True if an error occurred. If **status** is True, the VI does not perform any operations.



**code** is the error code number identifying an error. A value of 0 means success. A negative value means error: VI did not execute the intended operation. A positive value means warning: VI executed intended operation, but an informational warning is returned. For a description of the **code**, wire the error cluster to a LabVIEW error-handling VI, such as the Simple Error Handler.



**source** identifies the VI where the error occurred.

### Output



**ObjHandle out** is the object handle for the next NI-CAN VI.



**ActualDataSize (Frames)** specifies the number of frames returned in **Data**. This number is less than or equal to **RequestedDataBufSize**.



**Data** returns an array of clusters. Each cluster in the array uses the typedef **CanDataTimed.ctl** with the following elements:



**Data** array returns 8 data bytes. The actual number of valid data bytes depends on the CAN Object configuration specified in **ncConfigCANObj.vi**.

If the CAN Object **Communication Type** specifies Transmit, data frames are transmitted, not received, so **Data** is ignored. For this Communication Type, **ncReadObjMult.vi** has no effect.

If the CAN Object **Communication Type** specifies Receive, **Data** always contains **Data Length** valid bytes, where **Data Length** was configured using **ncConfigCANObj.vi**.



**Timestamp** returns the absolute timestamp when the frame was placed into the read queue. The value matches the absolute timestamp format used within LabVIEW itself. LabVIEW time is a DBL representing the number of seconds elapsed since 12:00 a.m., Friday, January 1, 1904, Coordinated Universal Time (UTC). You can wire this **Timestamp** to LabVIEW time functions such as **Seconds To Date/Time**. You also can display the time in a numeric indicator of type DBL by using **Format & Precision** to select **Time & Date** format.



**Error out** describes error conditions. If the **Error in** cluster indicated an error, the **Error out** cluster contains the same information. Otherwise, **Error out** describes the error status of this VI.



**status** is True if an error occurred.



**code** is the error code number identifying an error. A value of 0 means success. A negative value means error: VI did not execute the intended operation. A positive value means warning: VI executed intended operation, but an informational warning is returned. For a description of the **code**, wire the error cluster to a LabVIEW error-handling VI, such as the Simple Error Handler.



**source** identifies the VI where the error occurred.

## Description

Since NI-CAN handles the read queue in the background, this VI does not wait for new frames to arrive. To ensure that new frames are available before calling **ncReadObjMult.vi**, first wait for the Read Available state or Read Multiple state using **ncWaitForState.vi**.

When you call **ncReadObjMult.vi** for an empty read queue (Read Available state false), **Error out** returns **success** (status=F, code=0), and **ActualDataSize (Frames)** returns 0.

When a frame arrives for a full read queue, NI-CAN discards the new frame, and the next call to **ncReadObjMult.vi** returns the error **CanErrOverflowRead** (status=T, code=BFF62028 hex). If you detect this overflow, try to read in a relatively tight loop (few milliseconds each read).

You can use the Network Interface and CAN Objects simultaneously. When a CAN frame arrives from the network, NI-CAN first checks the **ArbitrationId** for an open CAN Object. If no CAN Object applies, NI-CAN checks the comparators and masks of the Network Interface (including the Series 2 Filter Mode attributes). If the frame passes that filter, NI-CAN places the frame into the read queue of the Network Interface.

## ncSetAttr.vi

### Purpose

Set the value of an object attribute. The attributes provided in this VI allow for additional configuration beyond the attributes of **ncConfig** VIs.

### Format

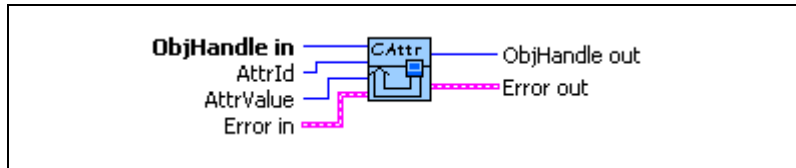

### Input



**ObjHandle in** is the object handle from the previous NI-CAN VI. The handle originates from **ncOpen.vi**.



**AttrId** specifies the attribute to set.

#### Baud Rate

For NI CAN hardware you can specify the following basic baud rates as the numeric rate: 5000, 6150, 7813, 8000, 10000, 12500, 15625, 16000, 20000, 25000, 31250, 33333, 40000, 50000, 62500, 80000, 83333, 100000, 125000, 160000, 200000, 250000, 400000, 500000, 800000, and 1000000.

You can specify advanced baud rates as 8000XXYY hex, where YY is the value of Bit Timing Register 0 (BTR0), and XX is the value of Bit Timing Register 1 (BTR1) of the SJA1000 CAN controller.

For NI LIN hardware you can specify any baud rate from 2400 to 20000 baud. If the baud rate you select varies more than .5% from the calculated baud rate, you will receive a warning message. The calculation for the baud rate is as follows:

$$\text{Calculated Baud Rate} = 1,500,000/x$$

where  $x = (1,500,000/\text{Input Baud Rate})$ , rounded to the nearest integer.



## LIN Checksum Type

Specifies the method the LIN interface should use when calculating checksums for published data, or verifying received checksums for subscribed-to data. The values for this attribute are:

0	Classic (default)
1	Enhanced

Setting the **LIN Checksum Type** to Classic indicates that the LIN-specified checksum calculation algorithm should be applied only to the data bytes. Setting the **LIN Checksum Type** to Enhanced indicates that the checksum calculation algorithm should be applied to the ID and data bytes.

## LIN Enable DLC Check

Specifies the manner in which the LIN interface detects end-of-response when writing a header **IsRemote** type. This attribute does not affect the LIN interface processing of the full and response **IsRemote** types. The values for this attribute are:

0	FALSE (default)
1	TRUE

When the LIN interface transmits a header, it expects an external slave to publish data in response. When writing headers, the LIN interface detects end-of-response using either the LIN-specified response timeout for a response containing the maximum number (8) of data bytes (**LIN Enable DLC Check=FALSE**), or reception of a response containing DLC number of data bytes (**LIN Enable DLC Check=TRUE**). If **LIN Enable DLC Check=FALSE**, then the minimum time separation between the transmission of headers will be *header time + time to subscribe to eight data bytes* (DLC is ignored) and *checksum + LIN interface inter-frame delay*. If **LIN Enable DLC Check=TRUE**, then the minimum time separation between the transmission of headers will be *header time + time to subscribe to DLC number of data bytes* and *checksum + LIN interface inter-frame delay*.

If you want to transmit header frames, each separated by a unique schedule table amount of delay with maximum timing accuracy, set **LIN Enable DLC Check** to TRUE. Note that if **LIN Enable DLC Check=TRUE**, the LIN interface will verify that a DLC in the range of one to eight is in the header **IsRemote** type written by the host. If **LIN Enable DLC Check=FALSE**, the LIN interface will ignore the DLC in the header **IsRemote** type written by the host.

**LIN Log Wakeup**

Specifies whether the LIN interface should report wakeup events as frames (TRUE) or not (FALSE). Wakeup events are always reported as states. The values for this attribute are:

0	FALSE (default)
1	TRUE

**LIN Response Timeout**

Specifies an amount of response timeout, in 50  $\mu$ s increments, to add to the LIN-specified response timeout the LIN interface uses to detect certain bus errors and end-of-response. The values for this attribute are:

0	(default)
1	1 to 65535 (50 $\mu$ s increments to add to LIN-specified response timeout)

**LIN Sleep**

Sets the sleep state of the LIN interface. The values for this attribute are:

0	FALSE (default)
1	TRUE

The LIN interface powers up in the awake state (**LIN Sleep**=FALSE). When the **LIN Sleep** attribute is set to FALSE, the user may set it to TRUE at any time: upon reception of a sleep frame (four second period of bus inactivity has passed), upon reception of a full frame containing go-to-sleep command data, or when it is desired to simply put the interface to sleep. When the **LIN Sleep** attribute is set to TRUE, either the user or the state machines within the LIN interface may set the attribute to FALSE, depending upon whether the interface is acting as master or slave, and whether or not it is issuing or receiving the wakeup request.

**Listen Only?**

Specifies whether to use the listen only feature of the Philips SJA1000 CAN controller.

Communication must be stopped to set this attribute. Use **Start On Open** False with **ncConfigCANNet.vi**, set the attribute, then use **ncAction.vi** to start communication.

0 FALSE (default)

When set to FALSE, listen only mode is disabled (default).

Received frames are ACKnowledged, and frames can be transmitted using **ncWriteNet.vi** and **ncWriteObj.vi**.

1 TRUE

When set to TRUE, listen only mode is enabled.

The Network Interface and CAN Objects can only receive frames. The interface does not transmit on the network: no ACKnowledgements are transmitted for received frames, and **ncWriteNet.vi** and **ncWriteObj.vi** will return an error. The Philips SJA1000 CAN controller enters error passive state when listen only is enabled.

The listen only mode is not available on the Intel 82527 CAN controller used by Series 1 CAN hardware (returns error).

This attribute is available only for the Network Interface, not CAN Objects.

### Log Bus Errors?

Specifies whether to log bus errors when the interface detects a bus error. For CAN interfaces, the bus error frame is logged when a bus error is detected. The **Log Bus Error?** attribute is not supported by Series 1 CAN interfaces. This attribute has to be set prior to starting the Network Interface. The values for this attribute are:

0 FALSE (default)

When set to FALSE, bus errors will not be logged and cannot be read (default).

1 TRUE

When set to TRUE, the Network Interface reports bus errors as a special frame in the read queue. For CAN, if the **Log Comm Warnings?** attribute is set to 1 (TRUE), the **Log Bus Errors?** attribute must be set to 0 (FALSE).

The CAN bus error frame has the following format:

Timestamp	Time when the bus error was detected.
Arbitration ID	0
IsRemote	6
DataLength	4

Data	Bytes
	0—Comm State (see description below)
	1—Transmit Error Counter
	2—Receive Error Counter
	3—ECC Register
	4—X
	5—X
	6—X
	7—X

**Note:** X means *Reserved* or *Don't Care*.

The first data byte (Comm State) indicates the current communication state of the CAN controller. The states are:

- 0—Error Active
- 1—Error Passive
- 2—Bus Off

For LIN interfaces, the bus error frame is logged into the read queue when a timeout or bus errors such as **Bit Framing** or **Checksum** occurs. This attribute must be set prior to starting the Network Interface.

The LIN bus error frame has the following format:

Timestamp	Time when the bus error was detected.
Arbitration ID	0
IsRemote	21
DataLength	4-7 (depends on Error code)

## Data

## Bytes

0—Error code (most significant byte)

1—Error code (least significant byte)

2—X

3—X

4—Received byte (for applicable error code)

5—Expected byte (for applicable error code)

6—LIN ID (for applicable error code)

7—X

**Note:** X means *Reserved* or *Don't Care*.

Data bytes zero and one (Error code) indicate the type of LIN bus error. Refer to Table 10-33 for a list of LIN bus error codes and descriptions. Data bytes two and three are reserved for internal use. For errors in which a received byte did not match the expected value, data byte four indicates the received value and data byte five indicates the expected value. For a bus error occurring at a point in the LIN frame after which the break, sync, and ID fields have been processed, data byte six indicates the LIN ID.



**Note** In Table 10-33, X means *Reserved*.

**Table 10-33.** LIN Bus Error Codes and Descriptions

Error Name	Error Code (hex)	Description	Frame Contents							
			DLC	B(0)	B(1)	B(2)	B(3)	B(4)	B(5)	B(6)
LinBusErrorNoResponse	8400	The LIN interface slave task received a header but no response.	7	84	00	X	X	0	0	ID
LinBusErrorResponseTooShort	8401	The LIN interface slave task received a header and only one byte of a response.	7	84	01	X	X	0	0	ID
LinBusErrorRxChecksumBit	C008	The LIN interface slave task received a checksum byte with a bit error.	7	C0	08	X	X	Received Checksum Byte	Expected Checksum Byte	ID
LinBusErrorRxChecksumFraming	A008	The LIN interface slave task received a checksum byte with a framing error.	7	A0	08	X	X	0	0	ID
LinBusErrorRxData0Framing	A010	The LIN interface slave task received data byte 0 with a framing error.	7	A0	10	X	X	0	0	ID
LinBusErrorRxData1Framing	A011	The LIN interface slave task received data byte 1 with a framing error.	7	A0	11	X	X	0	0	ID

**Table 10-33. LIN Bus Error Codes and Descriptions (Continued)**

Error Name	Error Code (hex)	Description	Frame Contents							
			DLC	B(0)	B(1)	B(2)	B(3)	B(4)	B(5)	B(6)
LinBusErrorRxData2Framing	A012	The LIN interface slave task received data byte 2 with a framing error.	7	A0	12	X	X	0	0	ID
LinBusErrorRxData3Framing	A013	The LIN interface slave task received data byte 3 with a framing error.	7	A0	13	X	X	0	0	ID
LinBusErrorRxData4Framing	A014	The LIN interface slave task received data byte 4 with a framing error.	7	A0	14	X	X	0	0	ID
LinBusErrorRxData5Framing	A015	The LIN interface slave task received data byte 5 with a framing error.	7	A0	15	X	X	0	0	ID
LinBusErrorRxData6Framing	A016	The LIN interface slave task received data byte 6 with a framing error.	7	A0	16	X	X	0	0	ID
LinBusErrorRxData7Framing	A017	The LIN interface slave task received data byte 7 with a framing error.	7	A0	17	X	X	0	0	ID
LinBusErrorRxIdFraming	A020	The LIN interface slave task received an ID byte with a framing error.	6	A0	20	X	X	Received ID Byte	Expected ID Byte	N/A
LinBusErrorRxIdParity	C020	The LIN interface slave task received an ID byte with a parity error.	6	C0	20	X	X	Received ID Byte	Expected ID Byte	N/A
LinBusErrorRxIdTimeout	9020	The LIN interface slave task did not receive an ID byte within the header timeout period.	4	90	20	X	X	N/A	N/A	N/A
LinBusErrorRxSyncBit	C040	The LIN interface slave task received a sync byte with a bit error.	6	C0	40	X	X	Received Sync Byte	Expected Sync Byte	N/A
LinBusErrorRxSyncFraming	A040	The LIN interface slave task received a sync byte with a framing error.	4	A0	40	X	X	N/A	N/A	N/A
LinBusErrorRxSyncTimeout	9040	The LIN interface slave task did not receive a sync byte within the header timeout period.	4	90	40	X	X	N/A	N/A	N/A
LinBusErrorTxData0Bit	4010	The LIN interface slave task transmitted data byte 0 and self-received it with a bit error.	7	40	10	X	X	Received Data Byte	Expected Data Byte	ID
LinBusErrorTxData1Bit	4011	The LIN interface slave task transmitted data byte 1 and self-received it with a bit error.	7	40	11	X	X	Received Data Byte	Expected Data Byte	ID
LinBusErrorTxData2Bit	4012	The LIN interface slave task transmitted data byte 2 and self-received it with a bit error.	7	40	12	X	X	Received Data Byte	Expected Data Byte	ID
LinBusErrorTxData3Bit	4013	The LIN interface slave task transmitted data byte 3 and self-received it with a bit error.	7	40	13	X	X	Received Data Byte	Expected Data Byte	ID
LinBusErrorTxData4Bit	4014	The LIN interface slave task transmitted data byte 4 and self-received it with a bit error.	7	40	14	X	X	Received Data Byte	Expected Data Byte	ID
LinBusErrorTxData5Bit	4015	The LIN interface slave task transmitted data byte 5 and self-received it with a bit error.	7	40	15	X	X	Received Data Byte	Expected Data Byte	ID

**Table 10-33.** LIN Bus Error Codes and Descriptions (Continued)

Error Name	Error Code (hex)	Description	Frame Contents							
			DLC	B(0)	B(1)	B(2)	B(3)	B(4)	B(5)	B(6)
LinBusErrorTxData6Bit	4016	The LIN interface slave task transmitted data byte 6 and self-received it with a bit error.	7	40	16	X	X	Received Data Byte	Expected Data Byte	ID
LinBusErrorTxData7Bit	4017	The LIN interface slave task transmitted data byte 7 and self-received it with a bit error.	7	40	17	X	X	Received Data Byte	Expected Data Byte	ID
LinBusErrorTxData0Framing	2010	The LIN interface slave task transmitted data byte 0 and self-received it with a framing error.	7	20	10	X	X	0	0	ID
LinBusErrorTxData1Framing	2011	The LIN interface slave task transmitted data byte 1 and self-received it with a framing error.	7	20	11	X	X	0	0	ID
LinBusErrorTxData2Framing	2012	The LIN interface slave task transmitted data byte 2 and self-received it with a framing error.	7	20	12	X	X	0	0	ID
LinBusErrorTxData3Framing	2013	The LIN interface slave task transmitted data byte 3 and self-received it with a framing error.	7	20	13	X	X	0	0	ID
LinBusErrorTxData4Framing	2014	The LIN interface slave task transmitted data byte 4 and self-received it with a framing error.	7	20	14	X	X	0	0	ID
LinBusErrorTxData5Framing	2015	The LIN interface slave task transmitted data byte 5 and self-received it with a framing error.	7	20	15	X	X	0	0	ID
LinBusErrorTxData6Framing	2016	The LIN interface slave task transmitted data byte 6 and self-received it with a framing error.	7	20	16	X	X	0	0	ID
LinBusErrorTxData7Framing	2017	The LIN interface slave task transmitted data byte 7 and self-received it with a framing error.	7	20	17	X	X	0	0	ID
LinBusErrorTxChecksumBit	4008	The LIN interface slave task transmitted a checksum and self-received it with a bit error.	7	40	08	X	X	Received Checksum Byte	Expected Checksum Byte	ID
LinBusErrorTxChecksumFraming	2008	The LIN interface slave task transmitted a checksum and self-received it with a framing error.	7	20	08	X	X	0	0	ID
LinBusErrorErrorWhenMaster ReceivesWakeup	8A00	The LIN interface as a master, failed to respond to reception of a wakeup on the LIN.	4	8A	00	X	X	N/A	N/A	N/A
LinBusErrorWhenMasterIssues Wakeup	0A00	The LIN interface failed to issue a wakeup on the LIN as a master.	4	0A	00	X	X	N/A	N/A	N/A
LinBusErrorWhenSlaveIssues Wakeup	900	The LIN interface failed to issue a wakeup on the LIN as a slave.	4	09	00	X	X	N/A	N/A	N/A



## Log Comm Warnings

Specifies whether to log communication warnings (including transceiver faults) to the Network Interface read queue.

The values for this attribute are:

0 FALSE

When set to FALSE, the Network Interface reports CAN communication warnings (including transceiver faults) in **Error out** of the read VIs. For more information, refer to [ncReadNetMult.vi](#).

1 TRUE

When set to TRUE, the Network Interface reports CAN communication warnings (including transceiver faults) by storing a special frame in the read queue. The communication warnings are not reported in **Error out**. For more information on communication warnings and errors, refer to [ncReadNetMult.vi](#). The special communication warning frame uses the following format:

Timestamp	Time when error/warning occurred
Arbitration ID	Error/warning ID (refer to <a href="#">ncReadNetMult.vi</a> )
IsRemote	2
DataLength	0
Data	N/A (ignore)

When calling [ncReadNet.vi](#) or [ncReadNetMult.vi](#) to read frames from the Network Interface, you typically use the IsRemote field to differentiate communications warnings from CAN frames. Refer to [ncReadNetMult.vi](#) for more information.

This attribute applies only to Series 1 and Series 2 hardware.

This attribute is available only from the Network Interface, not CAN Objects.

### Log Start Trigger?

Set this attribute to true if you wish to log the start trigger into the read queue of the CAN or LIN Network Interface Object.

The values for this attribute are:

0 FALSE

Disables the logging of the start trigger (default) in the read queue of the Network Interface Object.

1 TRUE

Enables the logging of the start trigger in the read queue of the Network Interface Object. The start trigger is logged when the hardware starts communication.

This attribute should be set prior to starting the Network Interface Object. This attribute is applicable only to the Network Interface Object and setting this attribute on CAN Objects will result in a NI-CAN error.



**Note** Setting this attribute to true in applications that only transmit CAN frames has no effect.

### Log Transceiver Faults?

Specifies whether to enable the logging of transceiver faults as frames in the read queue of the Network Interface Object. The values for this attribute are:

0 FALSE

When set to FALSE, transceiver faults will not be logged as frames (default).

1 TRUE

When set to TRUE, the transceiver faults are logged as special frames in the read queue of the Network Interface Object. For CAN, if the **Log Comm Warnings?** attribute is set to 1 (TRUE), **Log Transceiver Faults** must be set to 0 (FALSE).

This attribute is supported only on High Speed and Low Speed CAN transceivers.

This attribute can be set before or after starting the CAN Network Interface Object. The frame will be logged each time the transceiver's NERR signal changes state. In order to filter out noise on this signal, the logging can occur up to 10ms apart. The transceiver fault frame as the following format:

Timestamp	Time when the transceiver fault was detected
Arbitration ID	0
IsRemote	7
DataLength	1
Data	Bytes
	0—Transceiver fault (0=fault cleared, 1=fault present)
	1—X
	2—X
	3—X
	4—X
	5—X
	6—X
	7—X

Note: *X* means *Reserved* or *Don't Care*.

### Master Timebase Rate

Sets the rate (in MHz) of the external clock that is exported to the CAN card.

The values for this attribute are:

**20** (20 MHz)

When synchronizing 2 CAN cards or synchronizing a CAN card with an E-Series DAQ card, the 20 MHz **Master Timebase Rate** is to be used. By default, this attribute is set to 20 MHz.

**10 (10 MHz)**

The **Master Timebase Rate** should be set to 10 MHz when synchronizing a CAN card with an M-Series DAQ card. The M-Series DAQ card can export a 20 MHz clock but it does this by using one of its two counters.

If your CAN-DAQ application does not use the 2 DAQ counters then, you can leave the timebase rate set to 20 MHz (default).

This attribute can be set either before or after calling [ncConnectTerminals.vi](#) to connect the **RTSI\_CLK** to **Master Timebase**. However, this attribute must always be called prior to starting the Network Interface Object.

This attribute is applicable only to PCI and PXI Series 2 cards. For PCMCIA cards, setting this attribute will return an error. On PXI cards, if **PXI\_CLK10** is routed to the **Master Timebase**, then the rate is fixed at 10 MHz (it over rides any previous setting of this attribute). Setting this attribute for Series 1 cards will also result in a NI-CAN error.

For the 847x and 847x with Sync series CAN and LIN interfaces, setting this attribute has no effect. The 847x and 847x with Sync series CAN and LIN interfaces automatically synchronize to a Master Timebase Rate of 1 MHz, 10 MHz, or 20 MHz. Refer to Appendix E, [Specifications](#), for details on synchronization triggers.

**ReadMult Size for Notification**

Sets the number of frames used as a threshold for the Read Multiple state. For more information on the Read Multiple state, refer to [ncWaitForState.vi](#).

The default value is one half of **Read Queue Length**.

This attribute applies only to Series 1 and Series 2 hardware.

**Self Reception?**

For CAN, this specifies whether to echo successfully transmitted CAN frames into the read queue of the CAN Network Interface and/or CAN Objects. Each reception occurs just as if the frame were received from another CAN device.

For self reception to operate properly, another CAN device must receive and acknowledge each transmit. If a transmitted frame is not successfully acknowledged, it is not echoed into the read queue.

Communication must be stopped to set this attribute. Use **Start On Open** False with **ncConfigCANNNet.vi**, set the attribute, then use **ncAction.vi** to start communication.

0 FALSE

Disables Self Reception mode (default). Transmitted frames do not appear in read queues.

1 TRUE

Enables Self Reception mode. Transmitted frames appear in read queues as if they were received from another CAN device.

The Self Reception mode is not available on the Intel 82527 CAN controller used by Series 1 CAN hardware. For Series 1 interfaces, this attribute must be left at its default (zero).

For LIN, this specifies whether or not to load frames for which the LIN interface slave task is the publisher of the response into the read queue.

0 FALSE

Disables Self Reception mode (default). Frames for which the LIN interface slave task is the publisher of the response do not appear in read queues.

1 TRUE

Enables Self Reception mode. Frames for which the LIN interface slave task is the publisher of the response appear in read queues as if they were the result of an external slave task publishing the response.

This attribute is available only for the Network Interface Objects, not CAN Objects.

### Series 2 Comparator

Specifies the filter comparator for the Philips SJA1000 CAN controller. This attribute is not supported for Series 1 CAN, 847x LIN, or 847x with Sync LIN interfaces (returns error).

This attribute specifies a comparator value that is checked against the ID, RTR, and data bits. The **Series 2 Mask** determines the applicable bits for comparison.

The default value of this attribute is zero.

The mapping of bits in this attribute to the ID, RTR, and data bits of incoming frames is determined by the value of the **Series 2 Filter**

**Mode** attribute. Refer to the **Series 2 Filter Mode** attribute to understand the format of this attribute as well as the **Series 2 Mask**.

Communication must be stopped to set this attribute. Use **Start On Open** False with **ncConfigCANNet.vi**, set the desired attributes, then use **ncAction.vi** to start communication.

### Series 2 Mask

Specifies the filter mask for the Philips SJA1000 CAN controller. This attribute is not supported for Series 1 CAN, 847x LIN, or 847x with Sync LIN interfaces (returns error).

This attribute specifies a bit mask that determines the ID, RTR, and data bits that are compared. If a bit is clear in the mask, the corresponding bit in the **Series 2 Comparator** is checked. If a bit in the mask is set, that bit is ignored for the purpose of filtering (don't care). This interpretation is the opposite of the legacy **Standard/Extended Mask** attributes.

The default value of this attribute is hex FFFFFFFF, which means that all frames are received.

The mapping of bits in this attribute to the ID, RTR, and data bits of incoming frames is determined by the value of the **Series 2 Filter Mode** attribute. Refer to **Series 2 Filter Mode** to understand the format of this attribute as well as the **Series 2 Comparator**.

Communication must be stopped to set this attribute. Use **Start On Open** False with **ncConfigCANNet.vi**, set the desired attributes, then use **ncAction.vi** to start communication.

### Series 2 Filter Mode

The Philips SJA1000 CAN controller provides sophisticated filtering of received frames. This attribute specifies the filtering mode, which is used in conjunction with the Series 2 Mask and Series 2 Comparator attributes.

This attribute is not supported for Series 1 CAN, 847x LIN, or 847x with Sync LIN interfaces (returns error). For Series 1 interfaces, the Standard Mask/Comparator and Extended Mask/Comparator attributes are programmed directly into the Intel 82527 CAN controller. Use those attributes to specify filtering of received frames on Series 1 interfaces.

The Philips SJA1000 does not support distinct standard and extended masking. Therefore, on Series 2 interfaces the Standard Mask/Comparator and Extended Mask/Comparator attributes are implemented in software (for backward compatibility). Since software

masking can have an adverse impact on receive performance, National Instruments recommends that you disable software masking for Series 2 interfaces. Disable software masking by specifying don't-care (0) for all four mask/comparator attributes of **ncConfigCANNet.vi**.

Communication must be stopped to set this attribute. Use **Start On Open** False with **ncConfigCANNet.vi**, set the desired attributes, then use **ncAction.vi** to start communication.

Since the format of the filters is very specific to the Philips SJA1000 CAN controller, National Instruments cannot guarantee compatibility for this attribute on future hardware series. When using this attribute in the application, it is best to get the **Series** attribute to verify that the CAN hardware is Series 2, 847x, or 847x with Sync.

The filtering specified by this attribute and the Series 2 Mask/Comparator applies to the CAN Network Interface Object and all CAN Objects for that interface. For example, if you specify filters that discard ID 5, then open a CAN Object to receive ID 5, the CAN Object will not receive data.

The default value for this attribute is **Single Standard**.

This attribute uses the following values:

#### 0 (Single Standard)

Filter all standard (11-bit) frames using a single mask/comparator filter.

Figure 10-5 describes the format of the Series 2 Mask and Series 2 Comparator attributes for this filter mode.

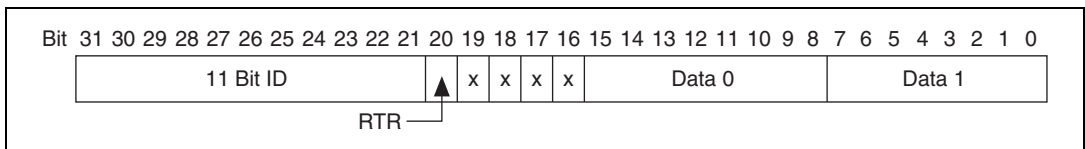

**Figure 10-5.** Mask/Comparator for Single-Standard Filter Mode

The 11 Bit ID compares all 11 bits of standard IDs. The RTR bit determines whether the filter compares remote (1) or data (0) frames. Bits marked as X are reserved, and should be cleared to zero by the application. Data 0 compares the first data byte in the frame, and Data 1 compares the second data byte.

#### 1 (Single Extended)

Filter all extended (29-bit) frames using a single mask/comparator filter.

Figure 10-6 describes the format of the Series 2 Mask and Series 2 Comparator attributes for this filter mode.

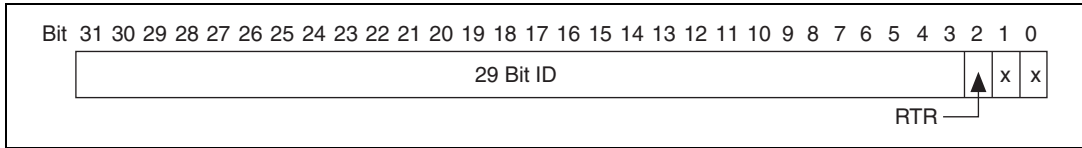

**Figure 10-6.** Mask/Comparator for Single-Extended Filter Mode

The 29 Bit ID compares all 29 bits of extended IDs. The RTR bit determines whether the filter compares remote (1) or data (0) frames. Bits marked as X are reserved, and should be cleared to zero by the application.

**2 (Dual Standard)**

Filter all standard (11-bit) frames using a two separate mask/comparator filters. If either filter matches the frame, it is received. The frame is discarded only when neither filter detects a match.

Figure 10-7 describes the format of the Series 2 Mask and Series 2 Comparator attributes for this filter mode.

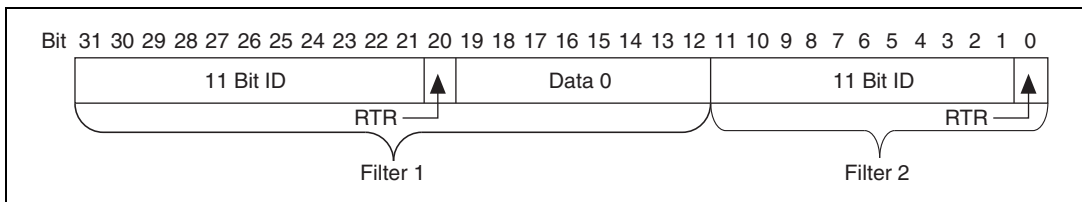

**Figure 10-7.** Mask/Comparator for Dual-Standard Filter Mode

Filter 1 includes the 11 Bit ID, the RTR bit, and the first data byte in the frame. Filter 2 includes the 11 bit ID, and the RTR bit (no data).

**3 (Dual Extended)**

Filter all extended (29-bit) frames using a two separate mask/comparator filters. If either filter matches the frame, it is received. The frame is discarded only when neither filter detects a match.



Figure 10-8 describes the format of the Series 2 Mask and Series 2 Comparator attributes for this filter mode.

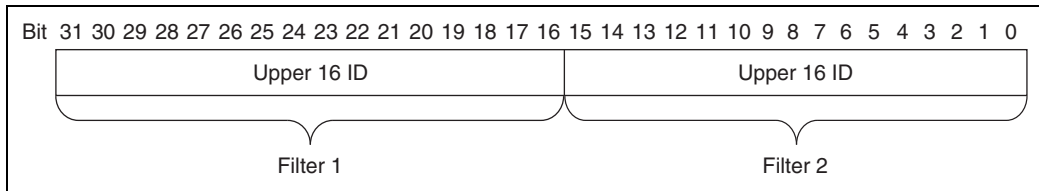

**Figure 10-8.** Mask/Comparator for Dual-Extended Filter Mode

Each Upper 16 ID filter compares the 16 most significant bits of the 29-bit extended ID.

### Single Shot Transmit?

Specifies whether to retry failed CAN frame transmissions (Series 2, 847x CAN, and 847x with Sync CAN interfaces only).

Communication must be stopped to set this attribute. Use **Start On Open** False with [ncConfigCANNet.vi](#), set the attribute, then use [ncAction.vi](#) to start communication.

0 Zero

Enables retry as defined in the CAN specification (default). If a CAN frame is not transmitted successfully, the CAN controller will immediately retry.

1 One

Single shot transmit. If a CAN frame is not transmitted successfully, the CAN controller will not retry.

For Series 1, 847x LIN, and 847x with Sync LIN interfaces, this attribute must be left at its default (zero).

This attribute is available only for the Network Interface, not CAN Objects.

### Termination

Specifies the termination setting for your hardware. This attribute is not supported on Series 1, Series 2, USB-8473, or USB-8473s hardware. The values for this attribute are:

**LS CAN**

- 0 (1.11 k $\Omega$ ) When set to 0 on USB-8472 or USB-8472s hardware, the termination is set to 1.11 k $\Omega$ .
- 1 (4.99 k $\Omega$ ) When set to 1 on USB-8472 or USB-8472s hardware, the termination is set to 4.99 k $\Omega$ .

**LIN**

- 0 (Disabled) When set to 0 on USB-8476 or USB-8476s hardware, the termination is disabled.
- 1 (Enabled) When set to 1 on USB-8476 or USB-8476s hardware, the termination is enabled.

**Timeline Recovery**

Specifies whether to configure the CAN Network Interface Object to recover the original timeline when a timestamped transmit is late.

This attribute is applicable only when the **Transmit Mode** attribute is set to **Timestamped Transmit (1)**.

Due to factors such as CAN bus arbitration, the time that a frame transmits successfully may be later than the original time specified. When a timestamped transmit is late, this attribute determines how NI-CAN will adjust transmit times for subsequent frames.

The values for this attribute are:

**0 (FALSE)**

Do not recover the original timeline.

Frames always transmit with the original gap or greater. This behavior is useful when you need to maintain a minimum gap between frames. Figure 10-9 shows an original timeline of three frames with a 10 ms gap. When frame B transmits 3 ms late, frame C continues to transmit 10 ms later, so the actual timeline slips.

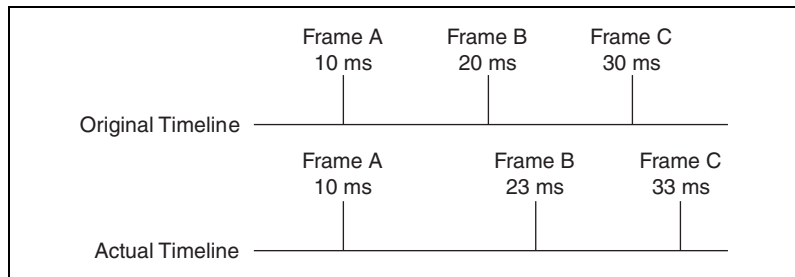

**Figure 10-9.** Example with Time Recovery Disabled

**1 (TRUE)**

Recover the original timeline.

When a timestamped transmit is late, the subsequent frame will transmit with a reduced gap. This behavior is useful when you need to maintain a timeline, such as when synchronizing CAN output with analog or digital output. Figure 10-10 shows an original timeline of three frames with a 10 ms gap. When frame B transmits 3 ms late, frame C transmits 7 ms later in order to recover the timeline.

The default value for this attribute is FALSE.

This attribute has to be set prior to starting the CAN Network Interface Object.

This attribute applies only to Series 1 and Series 2 hardware.

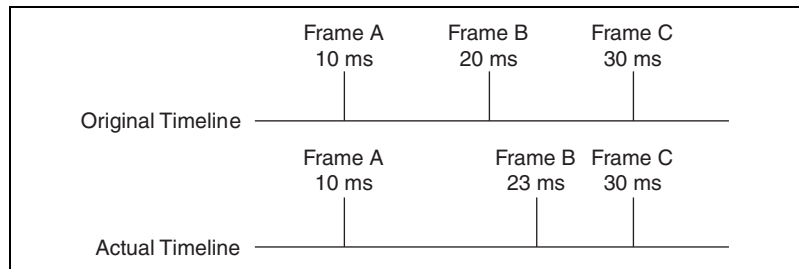

**Figure 10-10.** Example with Time Recovery Enabled

### Timestamp Format

Sets the format of the timestamps reported by the on-board timer on the CAN or LIN hardware.

The default value for this attribute is Absolute.

The values for this attribute are:

**0 (Absolute)**

Sets the timestamp format to absolute. In the absolute format, the timestamp returned by NI-CAN read functions is the LabVIEW date/time format (DBL representing the number of seconds elapsed since 12:00 a.m., Friday, January 1, 1904).

**1 (Relative)**

Sets the timestamp format to relative. In the relative format, the timestamp returned by the NI-CAN read functions will be zero based (DBL representing the number of seconds since the start trigger occurred).

A typical use case for this attribute would be if data received from two RTSI synchronized CAN or LIN cards is to be correlated. For that use case, this attribute must be set to 1 for all of the CAN or LIN cards being synchronized. Setting this attribute on one port of a 2-port card will also reset the timestamp of the second port, since resetting the timestamp on the port resets the on-board timer.

This attribute should be set prior to starting any communication on the CAN or LIN hardware.

### Transceiver External Outputs

Sets the transceiver external outputs for the Network Interface.

This attribute is available only for the Network Interface, not CAN Objects. Nevertheless, the attribute applies to communication by CAN Objects as well as the associated Network Interface.

Series 2 XS cards enable connection of an external transceiver. For an external transceiver, this attribute allows you to set the output voltage on the MODE0 and MODE1 pins of the CAN port, and it allows you to control the sleep mode of the on-board CAN controller chip.

For many models of CAN transceiver, EN and NSTB pins control the transceiver mode, such as whether the transceiver is sleeping, or communicating normally. For such transceivers, you can wire the EN and NSTB pins to the MODE0 and MODE1 pins of the CAN port.

The default value of this attribute is 00000003 hex. For many models of transceiver, this specifies normal communication mode for the transceiver and CAN controller chip. If the transceiver requires a different MODE0/MODE1 combination for normal mode, you can use external inverters to change the default 5 V to 0 V.

This attribute is supported for Series 2 XS cards only. This attribute is not supported when the **Transceiver Type** is any value other than External. To control the mode of an internal transceiver, use the **Transceiver Mode** attribute.

This attribute uses a bit mask. Use bitwise OR operations to set multiple values.

#### 00000001 hex (MODE0)

Set this bit to drive 5 V on the MODE0 pin. This is the default value. This bit is set automatically when a remote wakeup is detected.

Clear this bit to drive 0 V on the MODE0 pin.

**00000002 hex (MODE1)**

Set this bit to drive 5 V on the MODE1 pin. This is the default value. This bit is set automatically when a remote wakeup is detected.

Clear this bit to drive 0 V on the MODE1 pin.

**00000100 hex (Sleep CAN controller chip)**

Set this bit to place the CAN controller chip into sleep mode. This bit controls the mode of the CAN controller chip (sleep or normal), and the independent MODE0/MODE1 bits control the mode of the external transceiver. When you set this bit to place the CAN controller into sleep mode, you typically specify MODE0/MODE1 bits that place the external transceiver into sleep mode as well.

When the CAN controller is asleep, a remote wakeup will automatically place the CAN controller into its normal mode of communication. In addition, the MODE0/MODE1 pins are restored to their default values of 5 V. Therefore, a remote wakeup causes this attribute to change from the value that you set for sleep mode, back to its default 00000003 hex. You can determine when this has occurred by getting **Transceiver External Outputs** using [ncGetAttr.vi](#). For more information on remote wakeup, refer to the **Transceiver Mode** attribute for internal transceivers.

Clear this bit to place the CAN controller chip into normal communication mode. If the CAN controller was previously in sleep mode, this performs a local wakeup to restore communication.

**Transceiver Mode**

Sets the transceiver mode for the Network Interface. The transceiver mode controls whether the transceiver is asleep or communicating, as well as other special modes.

This attribute is available only for the Network Interface, not CAN Objects. Nevertheless, the attribute applies to communication by CAN Objects as well as the associated Network Interface.

This attribute is supported on Series 2, 847x CAN, and 847x with Sync CAN interfaces only.

For Series 2 cards for the PCMCIA form factor, this property requires a corresponding Series 2 cable (dongle). For information on how to identify the series of the PCMCIA cable, refer to the [Series 2 Vs. Series 1](#) section of Chapter 1, [Introduction](#).

For Series 2 XS cards, this attribute is not supported when the **Transceiver Type** is **External**. To control the mode of an external transceiver, use the **Transceiver External Outputs** attribute.

The default value for this attribute is Normal.

This attribute uses the following values:

**0** (Normal)

Set transceiver to normal communication mode. If you set Sleep mode previously, this performs a local wakeup of the transceiver and CAN controller chip.

**1** (Sleep)

Set transceiver and the CAN controller chip to sleep (or standby) mode.

If the transceiver supports multiple sleep/standby modes, the NI CAN hardware implementation ensures that all of those modes are equivalent with regard to the transceiver's behavior on the network. For more information on the physical specifications of each transceiver's normal and sleep modes, refer to Chapter 3, [NI CAN and LIN Hardware](#).

You can set Sleep mode only while the interface is communicating. If the Network Interface has not been started, setting the transceiver mode to Sleep will return an error.

When the interface enters sleep mode, communication is not possible until a wakeup occurs. All pending frame transmissions are deferred until the wakeup occurs. The transceiver and CAN controller wake from sleep mode when either a local wakeup or remote wakeup occurs.

A *local wakeup* occurs when the application sets the transceiver mode to Normal (or some other communication mode).

A *remote wakeup* occurs when a remote node transmits a CAN frame (referred to as the wakeup frame). The wakeup frame wakes up the transceiver and CAN controller chip of the NI CAN interface. The wakeup frame is not received or acknowledged by the CAN controller chip. When the wakeup frame ends, the NI CAN interface enters Normal mode, and again receives and transmits CAN frames. If the node that transmitted the wakeup frame did not detect an acknowledgement (such as if other nodes were also waking), it will retry the transmission, and the retry will be received by the NI CAN interface.

For a remote wakeup to occur for Single Wire transceivers, the node that transmits the wakeup frame must first place the network into the Single Wire Wakeup Transmission mode by asserting a higher voltage (typically 12 V). For more information, refer to mode 2 (Single Wire Wakeup).

When the local or remote wakeup occurs, frame transmissions resume from the point at which the original Sleep was set.

You can detect when a remote wakeup occurs by using [ncGetAttr.vi](#) with the **Transceiver Mode** attribute. If you need to suspend the application while waiting for the remote wakeup, use the Remote Wakeup state of [ncWaitForState.vi](#).

## 2 (Single Wire Wakeup)

Set Single Wire transceiver to Wakeup Transmission mode.

This mode is supported on Single Wire (SW) ports only.

The Single Wire Wakeup Transmission mode drives a higher voltage level on the network to wakeup all sleeping nodes. Other than this higher voltage, this mode is similar to Normal mode. CAN frames can be received and transmitted normally.

Since you use the Single Wire Wakeup mode to wakeup other nodes on the network, it is not typically used in combination with Sleep mode for a given interface.

The timing of how long the wakeup voltage is driven is controlled entirely by the application. The application will typically change to Single Wire Wakeup mode, transmit a wakeup frame, then return to Normal mode.

The following sequence demonstrates a typical sequence of steps for sleep and wakeup between two Single Wire NI CAN interfaces. The sequence assumes that CAN0 is the sleeping node, and CAN1 originates the wakeup.

1. Start both CAN0 and CAN1. Both use the default Normal mode.
2. Set **Transceiver Mode** of CAN0 to Sleep.
3. Set **Transceiver Mode** of CAN1 to Single Wire Wakeup.
4. Write data to CAN1 to transmit a wakeup frame to CAN0.
5. Set **Transceiver Mode** of CAN1 to Normal.
6. Now both CAN0 and CAN1 are in Normal mode again.

## 3 (Single Wire High-Speed)

Set Single Wire transceiver to High-Speed Transmission mode.

This mode is supported on Single Wire (SW) ports only.

The Single Wire High-Speed Transmission mode disables the internal waveshaping function of the transceiver, which allows baud rates up to 100 kbytes/s to be used. The disadvantage versus Normal (which allows up to 40 kbytes/s baud) is degraded EMC performance. Other than the disabled waveshaping, this mode is similar to Normal mode. CAN frames can be received and transmitted normally.

This mode has no relationship to High-Speed (HS) transceivers. It is merely a higher speed mode of the Single Wire (SW) transceiver, typically used for downloading large amounts of data to a node.

The Single Wire transceiver does not support use of this mode in conjunction with Sleep mode. For example, a remote wakeup cannot transition from Sleep to this Single Wire High-Speed mode.

### Transceiver Type

For XS software selectable physical layer cards that provide a software-switchable transceiver, the **Transceiver Type** attribute sets the type of transceiver. When the transceiver is switched from one type to another, NI-CAN ensures that the switch is undetectable from the perspective of other nodes on the network.

The default value for this attribute is specified within MAX. If you change the transceiver type in MAX to correspond to the network in use, you can avoid setting this attribute within the application.

This attribute is available only for the Network Interface, not CAN Objects. Nevertheless, the attribute applies to communication by CAN Objects as well as the associated Network Interface.

Communication for all objects on the Network Interface must be stopped prior to setting this attribute. You typically do this by calling **ncConfigCANNet.vi** with **Start On Open** set to false, then **ncOpen.vi** of the Network Interface, then **ncSetAttr.vi** to set **Transceiver Type**, then **ncAction.vi** to start communication. Prior to changing the **Transceiver Type** again, you must use **ncAction.vi** to stop communication.

You can only set this attribute for Series 2 XS interfaces.

This attribute uses the following values:

**0** (High-Speed)

Switch the transceiver to High-Speed (HS).



**1** (Low-Speed/Fault-Tolerant)

Switch the transceiver to Low-Speed/Fault-Tolerant (LS).

**2** (Single Wire)

Switch the transceiver to Single Wire (SW).

**3** (External)

Switch the transceiver to External. The External type allows you to connect a transceiver externally to the interface. For more information on connecting transceivers externally, refer to Chapter 3, *NI CAN and LIN Hardware*.

When this transceiver type is selected, you can use the **Transceiver External Outputs** and **Transceiver External Inputs** attributes to access the external mode and status pins of the connector.

**4** (Disconnect)

Disconnect the CAN controller chip from the connector. This value is used when you physically switch an external transceiver. You first set **Transceiver Type** to Disconnect, then switch from one external transceiver to another, then set **Transceiver Type** to External. For more information on connecting transceivers externally, refer to Chapter 3, *NI CAN and LIN Hardware*.

**Transmit Mode**

Specifies whether to configure the CAN Network Interface Object to **Immediate Transmit** mode or **Timestamped Transmit** mode.

The default value for this attribute is zero (Immediate Transmit).

The values for this attribute are:

**0** (Immediate Transmit)

Configures the Network Interface Object in the **Immediate Transmit** mode. In the **Immediate Transmit** mode, the CAN frames are transmitted as soon as they are written into the Network Interface Object's write queue. CAN frames can be written into the Network Interface Objects write queue by either using [ncWriteNet.vi](#) or [ncWriteNetMult.vi](#). Timestamps are ignored by NI-CAN when the Network Interface Object is configured in this mode.

**1** (Timestamped Transmit)

Configures the Network Interface Object in the **Timestamped Transmit** mode. In this mode, NI-CAN spaces the frame transmission according to the difference in timestamps between

consecutive frames. For example, if every frame provided to [ncWriteNetMult.vi](#) increments by 10 milliseconds, the frames will be transmitted with a 10 millisecond gap.

If the timestamp of the CAN frame to be transmitted is less than the timestamp of the previous CAN frame, **Timestamped Transmit** is reset and the CAN frame will be transmitted immediately on the bus without adding any delay. For example, if you write a frame with a relative timestamp 30 ms followed by a frame with a timestamp 15 ms, the two frames will be transmitted back to back.

Use [ncWriteNetMult.vi](#) to write CAN frames with timestamps into the write queue of the Network Interface Object.

To use the [ncWriteNet.vi](#) in **Timestamped Transmit** mode, refer to the description of [ncWriteNet.vi](#).

This attribute has to be set prior to starting the CAN Network Interface Object.

This attribute applies only to Series 1 and Series 2 interfaces.

### User RTSI Frame

Sets the user RTSI frame. This attribute is normally configured using the **UserRTSIFrame** input of [ncConfigCANObjRTSI.vi](#). This attribute allows that value to be changed while running. For more information, refer to [ncConfigCANObjRTSI.vi](#).

This attribute is available only for CAN Objects, not the Network Interface.

### Virtual Bus Timing

Sets the Virtual Bus Timing of the virtual device.

The values for this attribute are:

#### 0 (FALSE)

Virtual Bus Timing is turned off. By turning Virtual Bus Timing off, the CAN bus simulation is disabled and CAN frames are copied from the write queue of one virtual interface to the read queue of the second virtual interface. This setting is useful if you desire to only convert frames to channels or vice versa and not simulate actual CAN bus communication.

#### 1 (TRUE)

Virtual Bus Timing is turned on (default). By turning Virtual Bus Timing on, frame timestamps are recalculated as they transfer

across the virtual bus. This mode is useful when you want the virtual bus to behave as much like a real bus as possible.

If this attribute is set on real hardware, an error will be returned.

The Virtual Bus Timing has to be set to the same value on both virtual interfaces.

This attribute must be set prior to starting the virtual interface.

Refer to the *Frame to Channel Conversion* section of Chapter 6, *Using the Channel API* for more information.



**AttrValue** provides the attribute value for **AttrId**.

**Error in** describes error conditions occurring before the VI executes. If an error has already occurred, the VI returns the value of the **Error in** cluster in **Error out**.



**status** is True if an error occurred. If **status** is True, the VI does not perform any operations.



**code** is the error code number identifying an error. A value of 0 means success. A negative value means error: VI did not execute the intended operation. A positive value means warning: VI executed intended operation, but an informational warning is returned. For a description of the **code**, wire the error cluster to a LabVIEW error-handling VI, such as the Simple Error Handler.



**source** identifies the VI where the error occurred.

## Output



**ObjHandle out** is the object handle for the next NI-CAN VI.

**Error out** describes error conditions. If the **Error in** cluster indicated an error, the **Error out** cluster contains the same information. Otherwise, **Error out** describes the error status of this VI.



**status** is True if an error occurred.



**code** is the error code number identifying an error. A value of 0 means success. A negative value means error: VI did not execute the intended operation. A positive value means warning: VI executed intended operation, but an informational warning is returned. For a description of the **code**, wire the error cluster to a LabVIEW error-handling VI, such as the Simple Error Handler.



**source** identifies the VI where the error occurred.

## Description

**ncSetAttr.vi** sets the value of the attribute specified by **AttrId** in the object specified by **ObjHandle in**.

## ncWaitForState.vi

### Purpose

Wait for one or more states to occur in an object.

### Format

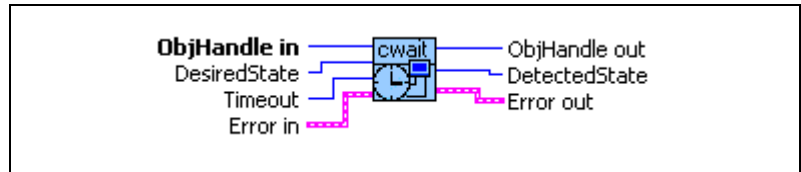

### Input



**ObjHandle in** is the object handle from the previous NI-CAN VI. The handle originates from **ncOpen.vi**.



**DesiredState** specifies a bit mask of states for which notification is desired. You can use a single state alone, or you can OR them together:

#### 00000001 hex Read Available

At least one frame is available, which you can obtain using an appropriate read VI.

The state is set whenever a frame arrives for the object. The state is cleared when the read queue is empty.

#### 00000002 hex Write Success

All frames provided through write VIs have been successfully transmitted onto the network. Successful transmit means that the frame won arbitration, and was acknowledged by a remote device.

The state is set when the last frame in the write queue is transmitted successfully. The state is cleared when a write VI is called.

When communication starts, the Write Success state is true by default.

For CAN, write success means that the frame won arbitration, and was acknowledged by a remote device. For LIN, write success means that the frame was successfully processed by the LIN interface.

**00000008 hex Read Multiple**

A specified number of frames are available, which you can obtain using either [ncReadNetMult.vi](#) or [ncReadObjMult.vi](#). The number of frames is configured using the **ReadMult Size for Notification** attribute of [ncSetAttr.vi](#).

The state is set whenever the specified number of frames are stored in the read queue of the object. The state is cleared when you call the read VI, and less than the specified number of frames exist in the read queue.

This state applies only to Series 1 and Series 2 interfaces.

**00000040 hex Remote Wakeup**

A Remote Wakeup event occurred and the Transceiver Mode for your CAN hardware has changed from Sleep to Normal. For more information on remote wakeup, refer to **Transceiver Mode**.

This state is set when a Remote Wakeup event occurs (end of wakeup frame). This state is not set when the application changes **Transceiver Mode** from Sleep to Normal (local wakeup).

This state is cleared when:

- You open the Network Interface, such as when the application begins.
- You stop the Network Interface.
- You set the **Transceiver Mode**, such as each time you set Sleep mode.

For as long as this state is true, the **Transceiver Mode** is Normal. The **Transceiver Mode** also can be Normal when this state is false, such as when you perform a local wakeup.

**00000080 hex Write Multiple**

The state is set whenever there is free space in the write queue to accept at least 512 frames to write. The state is cleared when you call [ncWriteNet.vi](#) or [ncWriteNetMult.vi](#) and less than 512 frames can be accepted to write in the write queue.

This state is valid only on the Network Interface.



**Timeout** specifies the maximum number of milliseconds to wait for one of the states in **DesiredState**. If the **Timeout** expires before a state occurs, the error **CanErrFunctionTimeout** is returned in **Error out** (status=T, code= BFF62001 hex). If **Timeout** is unwired, the default value of 0 will cause the wait to return the current status immediately. Thus, it will behave like calling [ncGetAttr.vi](#) for the Object State attribute.



**Error in** describes error conditions occurring before the VI executes. If an error has already occurred, the VI returns the value of the **Error in** cluster in **Error out**.



**status** is True if an error occurred. If **status** is True, the VI does not perform any operations.



**code** is the error code number identifying an error. A value of 0 means success. A negative value means error: VI did not execute the intended operation. A positive value means warning: VI executed intended operation, but an informational warning is returned. For a description of the **code**, wire the error cluster to a LabVIEW error-handling VI, such as the Simple Error Handler.



**source** identifies the VI where the error occurred.

## Output



**ObjHandle out** is the object handle for the next NI-CAN VI.



**DetectedState** is the current state of object when desired states occur. If an error caused the wait to abort, **DetectedState** is zero.



**Error out** describes error conditions. If the **Error in** cluster indicated an error, the **Error out** cluster contains the same information. Otherwise, **Error out** describes the error status of this VI.



**status** is True if an error occurred.



**code** is the error code number identifying an error. A value of 0 means success. A negative value means error: VI did not execute the intended operation. A positive value means warning: VI executed intended operation, but an informational warning is returned. For a description of the **code**, wire the error cluster to a LabVIEW error-handling VI, such as the Simple Error Handler.



**source** identifies the VI where the error occurred.

## Description

Use **ncWaitForState.vi** to wait for one or more states to occur in the object specified by **ObjHandle**. If an error occurs in the object, wait aborts and returns the error in **Error out**.

While waiting for the desired states, **ncWaitForState.vi** suspends execution of the current LabVIEW thread. VIs assigned to other threads can still execute. The thread of a VI can be changed in the **Priority** control in the **Execution** category of VI properties.

You cannot invoke **ncWaitForState.vi** twice from different VIs for the same object. For different object handles, these functions can overlap in execution.



**Note** The **ncWaitForState.vi** function was formerly **ncWait.vi**.



# ncWriteNet.vi

## Purpose

Write a single frame to a CAN or LIN Network Interface Object.

## Format

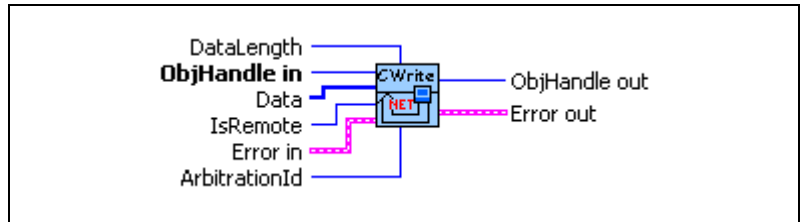

## Input



**ObjHandle in** is the object handle from the previous NI-CAN VI. The handle originates from **ncOpen.vi**.



**Note** The description of the input terminals is specified by the frame type. The value of **IsRemote** indicates the frame type. For a description of each frame type, refer to the *Frame Types* section of this function reference.



**Error in** describes error conditions occurring before the VI executes. If an error has already occurred, the VI returns the value of the **Error in** cluster in **Error out**.



**status** is True if an error occurred. If **status** is True, the VI does not perform any operations.



**code** is the error code number identifying an error. A value of 0 means success. A negative value means error: VI did not execute the intended operation. A positive value means warning: VI executed intended operation, but an informational warning is returned. For a description of the **code**, wire the error cluster to a LabVIEW error-handling VI, such as the Simple Error Handler.



**source** identifies the VI where the error occurred.

## Output



**ObjHandle out** is the object handle for the next NI-CAN VI. **Error out** describes error conditions. If the **Error in** cluster indicated an error, the **Error out** cluster contains the same information. Otherwise, **Error out** describes the error status of this VI.



**status** is True if an error occurred.



**code** is the error code number identifying an error. A value of 0 means success. A negative value means error: VI did not execute the intended operation. A positive value means warning: VI executed intended operation, but an informational warning is returned. For a description of the **code**, wire the error cluster to a LabVIEW error-handling VI, such as the Simple Error Handler.



**source** identifies the VI where the error occurred.

## Description

You use **ncWriteNet.vi** to place a frame into the Network Interface write queue. Since NI-CAN handles the write queue in the background, this VI does not wait for the frame to be transmitted on the network.

To transmit a set of frames as quickly as possible, simply call **ncWriteNet.vi** once per frame, without using **ncWaitForState.vi** after each write. This technique makes good use of the write queue to optimize frame transmission.

Once you have written frames, if you need to wait for the final **ncWriteNet.vi** to be transmitted successfully, use **ncWaitForState.vi** with the Write Success state. The Write Success state sets when all frames of the write queue have been successfully transmitted. The Write Success state clears whenever you call **ncWriteNet.vi**.

The **ncWriteNet.vi** and **ncWriteNetMult.vi** functions share a common write queue in the Network Interface. Therefore, when you set the **Transmit Mode** attribute to Timestamped Transmit, **ncWriteNetMult.vi** places timestamped frames into the queue, and **ncWriteNet.vi** places non-timestamped frames into the queue. If you write timestamped frames followed by a non-timestamped frame, the timestamped frames will transmit first, followed immediately by the non-timestamped frame. For example, assume you write 3 frames A, B, and C with **ncWriteNetMult.vi**, followed by frame D with **ncWriteNet.vi**, and frame E with **ncWriteNetMult.vi**. Frames A, B, and C will transmit in their timed sequence. Frame D immediately follows frame C. Frame E transmits with the expected time distance from frame C, because the non-timestamped frame does not affect **ncWriteNetMult.vi** timing.

Sporadic, recoverable errors on the network are handled automatically by the CAN protocol. As such, after **ncWriteNet.vi** returns successfully, NI-CAN eventually transmits the frame on the network unless there is a serious network problem. Network problems such as missing or

malfunctioning devices are often reported as the warning **CanWarmComm** (status=F, code=3FF6200B hex).

If the write queue is full, a call to **ncWriteNet.vi** returns the error **CanErrOverflowWrite** (status=T, code= BFF62008 hex). In many cases, this error is recoverable, so you should not exit the application when it occurs. For example, if you want to transmit thousands of frames in succession (for example, downloading code), the application can check for the error **CanErrOverflowWrite**, and when detected, simply wait a few milliseconds for some of the frames to transmit, then call **ncWriteNet.vi** again. If the second call to **ncWriteNet.vi** returns an error, that can be treated as an unrecoverable error (no other device is ACKING the frames).





Although the Network Interface allows **Write Queue Length** of zero, this is not recommended, because every new frame will always overwrite the previous frame.

## Frame Types





**IsRemote** indicates the frame type. The frame type determines the interpretation of the remaining fields. Table 10-34, *IsRemote value 0: CAN Data Frame*, Table 10-35, *IsRemote value 1: CAN Remote Frame*, Table 10-36, *IsRemote Value 16: LIN Response Entry Frame*, Table 10-37, *IsRemote Value 17: LIN Header Frame*, and Table 10-38, *IsRemote Value 18: LIN Full Frame*, describe the fields of the cluster for each value of **IsRemote**.

To determine if your hardware supports one of the following frame types for this function, refer to Appendix D, *Frame Types for CAN and LIN Hardware*.



**Table 10-34.** IsRemote value 0: CAN Data Frame

Field Name	Data Type	Description
IsRemote		Value 0 represents a CAN data frame. The CAN data frame contains data from the network.
ArbitrationId		Specifies the arbitration ID to transmit in the CAN data frame. A standard ID (11-bit) is specified by default. In order to specify an extended ID (29-bit), OR in the bit mask 20000000 hex.
DataLength		Indicates the number of data bytes in the <b>Data</b> array. If left unwired, a value of zero is assumed.
Data		Specifies the data bytes (8 maximum).



**Table 10-35.** IsRemote value 1: CAN Remote Frame

<b>Field Name</b>	<b>Data Type</b>	<b>Description</b>
IsRemote		Value 1 represents a CAN remote frame.
ArbitrationId		Specifies the arbitration ID of the remote frame to transmit.
DataLength		Specifies the number of bytes requested. The value is transmitted in the CAN remote frame, but with no data.
Data		Ignored. No data bytes are contained in a CAN remote frame.



**Table 10-36.** IsRemote Value 16: LIN Response Entry Frame

Field Name	Data Type	Description
IsRemote		<p>Value <b>16</b> represents a response entry frame for LIN communication. The behavior resulting from writing a response type to the LIN interface depends upon whether the <b>LIN Sleep</b> attribute is set to TRUE or FALSE (the LIN interface is asleep or awake, respectively).</p> <p>If the <b>LIN Sleep</b> attribute is set to FALSE:</p> <p>A response entry frame is issued when it is desired to configure the LIN interface slave task to subscribe to or publish data, in response to a particular header ID received from a master task. Each response entry frame indicates the ID of the header for which it is to respond, whether the response is to publish data or subscribe to data, and if it is to publish data, the data length code (DLC) and data values. The DLC determines whether the response will be to subscribe (DLC = 0), or publish (DLC = data length), in response to a header containing the ID of the response frame. Sixty-four response entry frames (one for each of the sixty-four LIN IDs) may be written to the response queue in the LIN interface. When the Network Interface is created or reset, the interface is reset to act as a slave and to respond as subscriber to data for all LIN IDs.</p> <p>If the <b>LIN Sleep</b> attribute is set to TRUE:</p> <p>A response entry frame is issued when the LIN interface has been acting as a slave (processing master headers), has been put asleep, and is desired to be used to wake the bus and initiate the transmission of headers by the master. When the response entry type is written to the LIN interface, two things occur. First, the response queue is loaded with the ID, DLC, and data (if DLC is non-zero meaning the response is to publish), of the response entry frame. Next the interface transmits a wakeup break on the bus. Per the LIN specification, it either waits until the master acknowledges the wakeup break by writing a header within the specified time, or re-transmits the wakeup break if it does not. When the master responds with a header, the LIN interface sets the <b>LIN Sleep</b> attribute to FALSE, and responds to the ID contained in the header in the manner (publish or subscribe) specified for that ID in the response queue.</p>
ArbitrationId		Zero to sixty-three.



**Table 10-36.** IsRemote Value 16: LIN Response Entry Frame (Continued)

Field Name	Data Type	Description
DataLength		Zero if the response is to subscribe to data. Actual length of <b>Data</b> if the response is to publish data.
Data		Ignored if <b>DataLength</b> is zero. Data to publish if <b>DataLength</b> is non-zero.

**Table 10-37.** IsRemote Value 17: LIN Header Frame

Field Name	Data Type	Description
IsRemote		<p>Value <b>17</b> represents a header frame for LIN communication. The behavior resulting from writing a header type to the LIN interface depends upon whether the <b>LIN Sleep</b> attribute is set to TRUE or FALSE (the LIN interface is asleep or awake, respectively).</p> <p>If the <b>LIN Sleep</b> attribute is set to FALSE:</p> <p>A header frame is issued when it is desired to use the LIN interface as a master, querying a slave task to publish data. Issuing a header frame causes the LIN interface to write a break-sync-id sequence to the LIN bus, with the expectation that a slave task will publish data. Once a header frame is issued, the LIN interface will behave as a master until the next time it is started.</p> <p>If the <b>LIN Sleep</b> attribute is set to TRUE:</p> <p>A header frame is issued when the LIN interface has been acting as a master (transmitting header and full <b>IsResponse</b> types), has been put asleep, and is desired to be used to wake the LIN bus and query a slave task to publish data. Issuing a header frame causes the LIN interface to write a wakeup break followed by break-sync-id sequence to the LIN bus, with the expectation that all slaves will wake up and a slave task will publish data in response. The LIN interface also sets the <b>LIN Sleep</b> attribute to FALSE.</p>
ArbitrationId		Zero to sixty-three.



**Table 10-37.** IsRemote Value 17: LIN Header Frame (Continued)

Field Name	Data Type	Description
DataLength		One to eight if the <b>Enable DLC Check</b> attribute is set to 1 (TRUE). If the <b>Enable DLC Check</b> attribute is set to 0 (FALSE), the data length is ignored.
Data		Ignored.

**Table 10-38.** IsRemote Value 18: LIN Full Frame

Field Name	Data Type	Description
IsRemote		<p>Value <b>18</b> represents a full frame for LIN communication. The behavior resulting from writing a full type to the LIN interface depends upon whether the <b>LIN Sleep</b> attribute is set to TRUE or FALSE (the LIN interface is asleep or awake, respectively).</p> <p>If the <b>LIN Sleep</b> attribute is set to FALSE:</p> <p>A full frame is issued when it is desired to use the LIN interface as a master, publishing data to an external slave. Issuing a full frame causes the LIN interface slave task response queue to be updated, the master task to write a header to the LIN bus, then the LIN interface slave task to publish a response, with the expectation that one or more external slaves will subscribe to the data. Once a full frame is issued, the LIN interface will behave as a master until the next time it is started.</p> <p>If the <b>LIN Sleep</b> attribute is set to TRUE:</p> <p>A full frame is issued when the LIN interface has been acting as a master (transmitting header and full <b>IsResponse</b> types), has been put asleep, and is desired to be used to wake the LIN bus and publish data to one or more external slaves. Issuing a full frame causes the LIN interface slave task response queue to be updated, the master task to write a wakeup break followed by a header to the LIN bus, then the LIN interface slave task to publish a response, with the expectation that all slaves will wake up and one or more external slaves will subscribe to the published data. The LIN interface also sets the <b>LIN Sleep</b> attribute to FALSE.</p>

**Table 10-38.** IsRemote Value 18: LIN Full Frame (Continued)

<b>Field Name</b>	<b>Data Type</b>	<b>Description</b>
ArbitrationId		Zero to sixty-three.
DataLength		One to eight.
Data		Data to publish.



## ncWriteNetMult.vi

### Purpose

Write multiple frames to a CAN or LIN Network Interface Object.

### Format

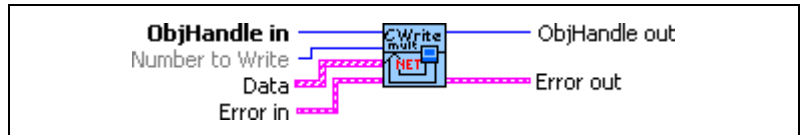

### Input



**ObjHandle in** is the object handle from the previous NI-CAN VI. The handle originates from [ncOpen.vi](#).



**Number To Write** indicates the number of frames in the **Data** array to write to the Network Interface.

This input is optional. When this input is unwired, the function will write all valid frames listed in the **Data** array. The **NumberToWrite** input is most useful when you have a large array of frames, and you only want to transmit a subset of that array.



**Data** is an array of clusters. Each cluster represents a CAN frame to write. The cluster uses the typedef **CanFrameTimed.ctl**, the same typedef as [ncReadNetMult.vi](#). Within each cluster, **IsRemote** indicates the frame type. The frame type determines the interpretation of the remaining fields. For a description of each frame type, refer to [Frame Types](#) section of this function reference.

The maximum number of clusters you can provide to each **ncWriteNetMult.vi** is 512. For more information, refer to the [Writing Large Numbers of Frames](#) section of this function reference.



**Error in** describes error conditions occurring before the VI executes. If an error has already occurred, the VI returns the value of the **Error in** cluster in **Error out**.



**status** is True if an error occurred. If **status** is True, the VI does not perform any operations.



**code** is the error code number identifying an error. A value of 0 means success. A negative value means error: VI did not execute

the intended operation. A positive value means warning: VI executed intended operation, but an informational warning is returned. For a description of the **code**, wire the error cluster to a LabVIEW error-handling VI, such as the Simple Error Handler.



**source** identifies the VI where the error occurred.

## Output



**ObjHandle out** is the object handle for the next NI-CAN VI.



**Error out** describes error conditions. If the **Error in** cluster indicated an error, the **Error out** cluster contains the same information. Otherwise, **Error out** describes the error status of this VI.



**status** is True if an error occurred.



**code** is the error code number identifying an error. A value of 0 means success. A negative value means error: VI did not execute the intended operation. A positive value means warning: VI executed intended operation, but an informational warning is returned. For a description of the **code**, wire the error cluster to a LabVIEW error-handling VI, such as the Simple Error Handler.



**source** identifies the VI where the error occurred.

## Description

Use **ncWriteNetMult.vi** to place one or more frames into the Network Interface write queue. This function does not wait for the frames to be transmitted on the network.

### Timestamped Transmit

In addition to supporting multiple frames, this function is preferable to **ncWriteNet.vi** in that it supports timestamped frames. To enable timestamped transmit, use **ncSetAttr.vi** to set the **Transmit Mode** attribute to Timestamped Transmit mode (1).

In Timestamped Transmit mode, NI-CAN times the transmission according to the difference in timestamps between consecutive frames. For example, if every frame provided to **ncWriteNetMult.vi** increments by 10 milliseconds, the frames will be transmitted with a 10 millisecond gap.

If the timestamp of one frame is less than the timestamp of the preceding frame, the timeline is reset, and both frames transmit back to back. For example, if you write a frame with relative timestamp 30 ms followed by a frame with timestamp 15 ms, the two frames will be transmitted back to back. This sort of behavior can occur when you transmit a logfile of

timestamped frames repeatedly, because on the second traversal of the logfile, the timestamp of the first frame will be less than the timestamp of the last frame.

The first frame that you provide to **ncWriteNetMult.vi** always transmits immediately, regardless of its timestamp. If you need to delay transmission of first frame after start, you can write a Delay frame or Start Trigger frame as described in the *Frame Types* section of this function reference.

**Timestamped Transmit** applies only to Series 1 and Series 2 interfaces.

847x CAN and LIN products do not support timestamped transmit. These products ignore the timestamp provided in the cluster for **ncWriteNetMult.vi**. If you use **ncWriteNetMult.vi** to write header and full frame types out of the USB LIN acting as master, then the frames will be transmitted together as closely as possible. If you use **ncWriteNetMult.vi** to write response frame types to the LIN interface acting as slave, then the frames will be loaded into the response table as quickly as possible.

## Immediate Transmit

The default value for the **Transmit Mode** attribute is **Immediate Transmit** mode (0).

In Immediate Transmit mode, NI-CAN ignores the timestamp in each frame, and transmits the frames as fast as possible. This behavior is equivalent to the **ncWriteNet.vi** function, except that you can write multiple frames for transmission in quick succession.

## Writing Large Numbers of Frames

Although NI-CAN provides a large write queue to store frames pending transmission, writing timestamped frames from a logfile with thousands of frames can eventually fill this queue.

When the Network Interface write queue cannot hold all frames provided, **ncWriteNetMult.vi** returns an overflow error. When this overflow error is returned, none of the frames provided in the **Data** array have been written. This enables your application to try the same **Data** array again at a later time.

To determine when adequate space is available in the write queue to retry **ncWaitForState.vi** with the **Write Multiple** state. The **Write Multiple** state will transition from false to true when space is available for at least 512 frames. Since you must limit the **Data** input of **ncWriteNetMult.vi** to 512 frames or less, the **Write Multiple** state indicates that a retry will succeed.

Another technique to recover from a write queue overflow is to use **ncGetAttr.vi** with the **Write Entries Free** attribute. Although this technique requires you to call **ncGetAttr.vi** periodically until the desired number of frame entries is available, it avoids the need to determine a proper Timeout for **ncWaitForState.vi**. When the time difference between

frames varies from milliseconds to seconds, it may be difficult to determine how long to wait for entries to become available.





After writing a sequence of timestamped frames with **ncWriteNetMult.vi**, you cannot close the Network Interface, because you must wait for the last timestamped frame to transmit onto the network. You can wait for the final transmit to complete using **ncWaitForState.vi** with the **Write Success** state. You can also use **ncGetAttr.vi** with the **Write Entries Pending** attribute to query periodically, which provides the option of aborting the timestamped transmission by closing the Network Interface.

## Frame Types

Within each cluster of the **Data** array, **IsRemote** indicates the frame type. The frame type determines the interpretation of the remaining fields. Table 10-39, *Cluster with IsRemote value 0: CAN Data Frame*, Table 10-40, *Cluster with IsRemote value 1: CAN Remote Frame*, Table 10-41, *Cluster with IsRemote value 4: Start Trigger Frame*, Table 10-42, *Cluster with IsRemote value 5: Delay Frame*, Table 10-43, *IsRemote Value 16: LIN Response Entry Frame*, Table 10-44, *IsRemote Value 17: LIN Header Frame*, and Table 10-45, *IsRemote Value 18: LIN Full Frame*, describe the fields of the cluster for each value of **IsRemote**.

To determine if your hardware supports one of the following frame types for this function, refer to Appendix D, *Frame Types for CAN and LIN Hardware*.





**Table 10-39.** Cluster with IsRemote value 0: CAN Data Frame

Field Name	Data Type	Description
IsRemote		Value 0 specifies a CAN data frame. The CAN data frame transfers data on the network.
ArbitrationId		Specifies the arbitration ID to transmit in the CAN data frame. A standard ID (11-bit) is specified by default. In order to specify an extended ID (29-bit), OR in the bit mask 20000000 hex.
DataLength		Specifies the number of bytes in the <b>Data</b> array to transmit in the CAN data frame.
Data		Data bytes to transmit in the CAN data frame.

**Table 10-39.** Cluster with IsRemote value 0: CAN Data Frame (Continued)

Field Name	Data Type	Description
Timestamp		<p>If the <b>Transmit Mode</b> attribute is Immediate Transmit (default), this field is ignored, and CAN frames transmit as quickly as possible.</p> <p>If the <b>Transmit Mode</b> attribute is Timestamped Transmit, this field specifies a timestamp. The timestamp is used to time transmission of CAN frames as described in the <i>Timestamped Transmit</i> section of this function reference.</p> <p>The timestamp is a LabVIEW numeric DBL with <b>Format and Precision</b> of <b>Absolute</b> time (time and date) or <b>Relative</b> time (zero based). The integer part contains seconds, and the fractional part contains milliseconds and microseconds.</p>



**Table 10-40.** Cluster with IsRemote value 1: CAN Remote Frame

Field Name	Data Type	Description
IsRemote		<p>Value 1 specifies a CAN remote frame.</p> <p>The CAN remote frame requests data for its arbitration ID.</p>
ArbitrationId		Specifies the arbitration ID of the remote frame to transmit.
DataLength		Specifies the number of bytes requested. The value is transmitted in the CAN remote frame, but with no data.
Data		Ignored. No data bytes are contained in a CAN remote frame.



**Table 10-40.** Cluster with IsRemote value 1: CAN Remote Frame (Continued)

Field Name	Data Type	Description
Timestamp		<p>If the <b>Transmit Mode</b> attribute is Immediate Transmit (default), this field is ignored, and CAN frames transmit as quickly as possible.</p> <p>If the <b>Transmit Mode</b> attribute is Timestamped Transmit, this field specifies a timestamp. The timestamp is used to time transmission of CAN frames as described in the <a href="#">Timestamped Transmit</a> section of this function reference.</p> <p>The timestamp is a LabVIEW numeric DBL with <b>Format and Precision</b> of <b>Absolute</b> time (time and date) or <b>Relative</b> time (zero based). The integer part contains seconds, and the fractional part contains milliseconds and microseconds. You can use either absolute or relative time, because the timing is determined solely on the difference in the timestamps of sequential frames.</p>



**Table 10-41.** Cluster with IsRemote value 4: Start Trigger Frame

Field Name	Data Type	Description
IsRemote		<p>Value 4 specifies a start trigger frame.</p> <p>When you use <b>ncWriteNetMult.vi</b> to write frames from a logfile for timestamped transmit, you can write the start trigger frame as the first frame. The start trigger frame reproduces the delay from start of communication to the first CAN frame. For example, if you write a start trigger frame followed by a CAN data frame with relative timestamp 20 ms, NI-CAN will delay 20 ms before transmitting the CAN data frame. If you write the CAN data frame without the start trigger frame, NI-CAN will transmit the CAN data frame immediately.</p>
ArbitrationId		Value 0 is required.
DataLength		Value 1 is required.



**Table 10-41.** Cluster with IsRemote value 4: Start Trigger Frame (Continued)

Field Name	Data Type	Description
Data		The single data byte in the array specifies the <b>Timestamp Format</b> (defined by <code>ncSetAttr.vi</code> ) used for all subsequent CAN frames. The value is 0 for absolute timestamps, and 1 for relative timestamps. In order for NI-CAN to delay the proper time for the start trigger, this timestamp format must match the format used in all subsequent frames provided to <code>ncWriteNetMult.vi</code> .
Timestamp		<p>Absolute timestamp of the start trigger. Within a logfile, this timestamp indicates the date and time at which CAN communication started.</p> <p>The timestamp is a LabVIEW numeric DBL with <b>Format and Precision</b> of <b>Absolute</b> time (date/time). The format of this timestamp is always absolute, even when <b>Data</b> byte 0 specifies relative timestamp format. This absolute timestamp provides data/time information even when the CAN frames of a logfile use the relative format.</p> <p>When <b>Data</b> byte 0 specifies absolute format (0), the difference between this timestamp and the absolute timestamp of the subsequent CAN frame is used as the delay for transmit of that CAN frame. When <b>Data</b> byte 0 specifies relative format (1), this timestamp is ignored by NI-CAN, and the relative timestamp of the subsequent CAN frame is used as the transmit delay.</p>

**Table 10-42.** Cluster with IsRemote value 5: Delay Frame



Field Name	Data Type	Description
IsRemote		<p>Value 5 specifies a delay frame.</p> <p>Use the delay frame to insert an additional delay between any two timestamped frames. For example, if you write a CAN frame with relative timestamp 20 ms, followed by a delay frame of 30 ms, followed by a CAN frame with timestamp 55 ms, NI-CAN will transmit the CAN frames 65 ms apart.</p>
ArbitrationId		Value 0 is required.

**Table 10-42.** Cluster with IsRemote value 5: Delay Frame (Continued)



Field Name	Data Type	Description
DataLength		Value 0 is required.
Data		Ignored.
Timestamp		<p>Specifies the delay to insert (not a timestamp).</p> <p>The delay is a LabVIEW numeric DBL with Format and Precision of Relative time. The integer part contains seconds, and the fractional part contains milliseconds and microseconds.</p> <p>The maximum delay supported is 180.0 seconds (3 minutes).</p>







**Table 10-43.** IsRemote Value 16: LIN Response Entry Frame

Field Name	Data Type	Description
IsRemote		<p>Value <b>16</b> represents a response entry frame for LIN communication. The behavior resulting from writing a response type to the LIN interface depends upon whether the <b>LIN Sleep</b> attribute is set to TRUE or FALSE (the LIN interface is asleep or awake, respectively).</p> <p>If the <b>LIN Sleep</b> attribute is set to FALSE:</p> <p>A response entry frame is issued when it is desired to configure the LIN interface slave task to subscribe to or publish data, in response to a particular header ID received from a master task. Each response entry frame indicates the ID of the header for which it is to respond, whether the response is to publish data or subscribe to data, and if it is to publish data, the data length code (DLC) and data values. The DLC determines whether the response will be to subscribe (DLC = 0), or publish (DLC = data length), in response to a header containing the ID of the response frame. Sixty-four response entry frames (one for each of the sixty-four LIN IDs) may be written to the response queue in the LIN interface. When the Network Interface is created or reset, the interface is reset to act as a slave and to respond as subscriber to data for all LIN IDs.</p> <p>If the <b>LIN Sleep</b> attribute is set to TRUE:</p> <p>A response entry frame is issued when the LIN interface has been acting as a slave (processing master headers), has been put asleep, and is desired to be used to wake the bus and initiate the transmission of headers by the master. When the response entry type is written to the LIN interface, two things occur. First, the response queue is loaded with the ID, DLC, and data (if DLC is non-zero meaning the response is to publish), of the response entry frame. Next the interface transmits a wakeup break on the bus. Per the LIN specification, it either waits until the master acknowledges the wakeup break by writing a header within the specified time, or re-transmits the wakeup break if it does not. When the master responds with a header, the LIN interface sets the <b>LIN Sleep</b> attribute to FALSE, and responds to the ID contained in the header in the manner (publish or subscribe) specified for that ID in the response queue.</p>
ArbitrationId		Zero to sixty-three.





**Table 10-43.** IsRemote Value 16: LIN Response Entry Frame (Continued)

Field Name	Data Type	Description
DataLength		Zero if the response is to subscribe to data. Actual length of <b>Data</b> if the response is to publish data.
Data		Ignored if <b>DataLength</b> is zero. Data to publish if <b>DataLength</b> is non-zero.
Timestamp		Ignored.

**Table 10-44.** IsRemote Value 17: LIN Header Frame

Field Name	Data Type	Description
IsRemote		<p>Value <b>17</b> represents a header frame for LIN communication. The behavior resulting from writing a header type to the LIN interface depends upon whether the <b>LIN Sleep</b> attribute is set to TRUE or FALSE (the LIN interface is asleep or awake, respectively).</p> <p>If the <b>LIN Sleep</b> attribute is set to FALSE:</p> <p>A header frame is issued when it is desired to use the LIN interface as a master, querying a slave task to publish data. Issuing a header frame causes the LIN interface to write a break-sync-id sequence to the LIN bus, with the expectation that a slave task will publish data. Once a header frame is issued, the LIN interface will behave as a master until the next time it is started.</p> <p>If the <b>LIN Sleep</b> attribute is set to TRUE:</p> <p>A header frame is issued when the LIN interface has been acting as a master (transmitting header and full <b>IsResponse</b> types), has been put asleep, and is desired to be used to wake the LIN bus and query a slave task to publish data. Issuing a header frame causes the LIN interface to write a wakeup break followed by break-sync-id sequence to the LIN bus, with the expectation that all slaves will wake up and a slave task will publish data in response. The LIN interface also sets the <b>LIN Sleep</b> attribute to FALSE.</p>
ArbitrationId		Zero to sixty-three.
DataLength		One to eight if the <b>Enable DLC Check</b> attribute is set to 1 (TRUE). If the <b>Enable DLC Check</b> attribute is set to 0 (FALSE), the data length is ignored.
Data		Ignored.
Timestamp		Ignored.

**Table 10-45.** IsRemote Value 18: LIN Full Frame

Field Name	Data Type	Description
IsRemote		<p>Value <b>18</b> represents a full frame for LIN communication. The behavior resulting from writing a full type to the LIN interface depends upon whether the <b>LIN Sleep</b> attribute is set to TRUE or FALSE (the LIN interface is asleep or awake, respectively).</p> <p>If the <b>LIN Sleep</b> attribute is set to FALSE:</p> <p>A full frame is issued when it is desired to use the LIN interface as a master, publishing data to an external slave. Issuing a full frame causes the LIN interface slave task response queue to be updated, the master task to write a header to the LIN bus, then the LIN interface slave task to publish a response, with the expectation that one or more external slaves will subscribe to the data. Once a full frame is issued, the LIN interface will behave as a master until the next time it is started.</p> <p>If the <b>LIN Sleep</b> attribute is set to TRUE:</p> <p>A full frame is issued when the LIN interface has been acting as a master (transmitting header and full <b>IsResponse</b> types), has been put asleep, and is desired to be used to wake the LIN bus and publish data to one or more external slaves. Issuing a full frame causes the LIN interface slave task response queue to be updated, the master task to write a wakeup break followed by a header to the LIN bus, then the LIN interface slave task to publish a response, with the expectation that all slaves will wake up and one or more external slaves will subscribe to the published data. The LIN interface also sets the <b>LIN Sleep</b> attribute to FALSE.</p>
ArbitrationId		Zero to sixty-three.
DataLength		One to eight.
Data		Data to publish.
Timestamp		Ignored.

## ncWriteObj.vi

### Purpose

Write a single frame to a CAN Object.

### Format

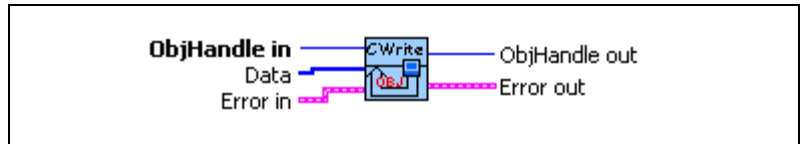

### Input



**ObjHandle in** is the object handle from the previous NI-CAN VI. The handle originates from [ncOpen.vi](#).



**Data** array specifies the data bytes (8 maximum).



**Error in** describes error conditions occurring before the VI executes. If an error has already occurred, the VI returns the value of the **Error in** cluster in **Error out**.



**status** is True if an error occurred. If **status** is True, the VI does not perform any operations.



**code** is the error code number identifying an error. A value of 0 means success. A negative value means error: VI did not execute the intended operation. A positive value means warning: VI executed intended operation, but an informational warning is returned. For a description of the **code**, wire the error cluster to a LabVIEW error-handling VI, such as the Simple Error Handler.



**source** identifies the VI where the error occurred.

### Output



**ObjHandle out** is the object handle for the next NI-CAN VI.



**Error out** describes error conditions. If the **Error in** cluster indicated an error, the **Error out** cluster contains the same information. Otherwise, **Error out** describes the error status of this VI.



**status** is True if an error occurred.



**code** is the error code number identifying an error. A value of 0 means success. A negative value means error: VI did not execute the intended operation. A positive value means warning: VI executed intended operation, but an informational warning is returned. For a description of the **code**, wire the error cluster to a LabVIEW error-handling VI, such as the Simple Error Handler.



**source** identifies the VI where the error occurred.

## Description

Use **ncWriteObj.vi** to place a frame into the CAN Object write queue. Since NI-CAN handles the write queue in the background, this VI does not wait for the frame to be transmitted on the network.

Once you have written frames, if you need to wait for the final **ncWriteObj.vi** to be transmitted successfully, use **ncWaitForState.vi** with the Write Success state. The Write Success state sets when all frames of the write queue have been successfully transmitted. The Write Success state clears whenever you call **ncWriteObj.vi**.

The Write Success state does not necessarily mean that all transmission has stopped for the CAN Object. For example, when the CAN Object **Communication Type** is Transmit Data Periodically, the Write Success state sets when the final frame in the write queue is transmitted, but the previous frame will be transmitted again once the **Period** expires.

Sporadic, recoverable errors on the network are handled automatically by the CAN protocol. As such, after **ncWriteObj.vi** returns successfully, NI-CAN eventually transmits the frame on the network unless there is a serious network problem. Network problems such as missing or malfunctioning devices are often reported as the warning **CanWarmComm** (status=F, code=3FF6200B hex).

If the write queue is full, a call to **ncWriteObj.vi** returns the error **CanErrOverflowWrite** (status=T, code= BFF62008 hex). In many cases, this error is recoverable, so you should not exit the application when it occurs. For example, if you want to transmit thousands of frames in succession (for example, large waveform transmitted periodically), the application can check for the error **CanErrOverflowWrite**, and when detected, simply wait a few milliseconds for some of the frames to transmit, then call **ncWriteObj.vi** again. If the second call to **ncWriteObj.vi** returns an error, that can be treated as an unrecoverable error (for example, no other device is ACKing the frames).

If you need to write a sequence of frames to the CAN Object, and ensure that each frame is transmitted, configure the **Write Queue Length** of the CAN Object to greater than zero. If you only need to transmit the most recent frame provided with **ncWriteObj.vi**, you can set the **Write Queue Length** to zero.

If the CAN Object **Communication Type** specifies Receive behavior, the **ncWriteObj.vi** VI can be used to transmit a remote frame. When using **ncWriteObj.vi** to transmit a remote frame, the **Data** input can be left unwired.

---

# Frame API for C

This chapter lists the NI-CAN functions and describes the format, purpose and parameters.

Unless otherwise stated, each NI-CAN function suspends execution of the calling thread until it completes. The functions in this chapter are listed alphabetically.

## Section Headings

---

The following are section headings found in the Frame API for C functions.

### **Purpose**

Each function description includes a brief statement of the purpose of the function.

### **Format**

The format section describes the format of each function for the C programming language.

### **Input and Output**

The input and output parameters for each function are listed.

### **Description**

The description section gives details about the purpose and effect of each function.

### **Network Interface Object**

The Network Interface Object section gives details about using the function with the Network Interface Object.

### **CAN Object**

The CAN Object section gives details about using the function with the CAN Object.



# Data Types

The following data types are used with functions of the NI-CAN Frame API for C.

**Table 11-1.** Data Types for NI-CAN Frame API for C

Data Type	Purpose
NCTYPE_INT8	8-bit signed integer
NCTYPE_INT16	16-bit signed integer
NCTYPE_INT32	32-bit signed integer
NCTYPE_UINT8	8-bit unsigned integer
NCTYPE_UINT16	16-bit unsigned integer
NCTYPE_UINT32	32-bit unsigned integer
NCTYPE_BOOL	Boolean value. Constants <code>NC_True</code> (1) and <code>NC_False</code> (0) are used for comparisons.
NCTYPE_STRING	ASCII string represented as an array of characters terminated by null character ( <code>\0</code> ).
NCTYPE_type_P	Pointer to a variable of type.
NCTYPE_ANY_P	Pointer to a variable of any type, used in cases where actual data type can vary depending on the object in use.
NCTYPE_OBJH	32-bit unsigned integer used to reference an open object in the Frame API.
NCTYPE_ATTRID	Attribute identifier. Uses constants with prefix <code>NC_ATTR_</code> .
NCTYPE_OPCODE	Operation code for <code>ncAction</code> function. Uses constants with prefix <code>NC_OP_</code> .
NCTYPE_STATE	Object states, encoded as a 32-bit mask, one bit for each state. Refer to <code>ncWaitForState</code> for more information.

**Table 11-1.** Data Types for NI-CAN Frame API for C (Continued)

Data Type	Purpose
NCTYPE_STATUS	Status returned from NI-CAN functions. Refer to <code>ncStatusToString</code> for more information.
NCTYPE_CAN_ARBID	CAN arbitration ID. The 30h bit is accessed using bitmask <code>NC_FL_CAN_ARBID_XTD</code> (2000000 hex). If this bit is clear, the CAN arbitration ID is standard (11-bit). If this bit is set, the CAN arbitration ID is extended (29-bit). Special constant <code>NC_CAN_ARBID_NONE</code> (CFFFFFFF hex) indicates no CAN arbitration ID, and is used to set the comparator attribute of the CAN Network Interface. Refer to <code>ncConfig</code> for more information.

## List of Functions

Table 11-2 contains an alphabetical list of the NI-CAN Frame API for C functions.

**Table 11-2.** NI-CAN Frame API for C Functions

Function	Purpose
<code>ncAction</code>	Perform an action on an object.
<code>ncCloseObject</code>	Close an object.
<code>ncConfig</code>	Configure an object before using it.
<code>ncConnectTerminals</code>	Connect terminals in the CAN or LIN hardware.
<code>ncCreateNotification</code>	Create a notification call back for an object.
<code>ncDisconnectTerminals</code>	Disconnect terminals in the CAN or LIN hardware.
<code>ncGetAttribute</code>	Get the value of an object attribute.
<code>ncGetHardwareInfo</code>	Get CAN and LIN hardware information.
<code>ncOpenObject</code>	Open an object.
<code>ncRead</code>	Read the data value of an object.
<code>ncReadMult</code>	Read multiple data values from the queue of an object.

**Table 11-2.** NI-CAN Frame API for C Functions (Continued)

<b>Function</b>	<b>Purpose</b>
<code>ncSetAttribute</code>	Set the value of an object attribute.
<code>ncStatusToString</code>	Convert status code into a descriptive string.
<code>ncWaitForState</code>	Wait for one or more states to occur in an object.
<code>ncWrite</code>	Write the data value of an object.
<code>ncWriteMult</code>	Write multiple frames to a CAN or LIN Network Interface Object.

## ncAction

---

### Purpose

Perform an action on an object.

### Format

```
NCTYPE_STATUS ncAction(
                    NCTYPE_OBJH  ObjHandle,
                    NCTYPE_OPCODE Opcode,
                    NCTYPE_UINT32 Param);
```

### Input

ObjHandle

Object handle from [ncOpenObject](#).

Opcode

Operation code indicating which action to perform.

Param

Parameter whose meaning is defined by Opcode.

### Output

#### Return Value

Status of the function call, returned as a signed 32-bit integer. Zero means the function executed successfully. Negative specifies an error, meaning the function did not perform expected behavior. Positive specifies a warning, meaning the function performed as expected, but a condition arose that might require attention. For more information, refer to [ncStatusToString](#).

### Description

[ncAction](#) is a general purpose function you can use to perform an action on the object specified by `ObjHandle`. Its normal use is to start and stop network communication on a CAN Network Interface Object.

For the most frequently used and/or complex actions, NI-CAN provides functions such as [ncOpenObject](#) and [ncRead](#). [ncAction](#) provides an easy, general purpose way to perform actions that are used less frequently or are relatively simple.

## CAN Network Interface Object

NI-CAN propagates all actions on the CAN Network Interface Object up to all open CAN Objects. Table 11-3 describes the actions supported by the CAN Network Interface Object.

**Table 11-3.** Actions Supported by the CAN or LIN Network Interface Object

Opcode	Param	Description
NC_OP_START (80000001 hex)	N/A (ignored)	Transitions network interface from stopped (idle) state to started (running) state. If network interface is already started, this operation has no effect. When a network interface is started, it is communicating on the network. When you execute NC_OP_START on a stopped CAN Network Interface Object, NI-CAN propagates it upward to all open higher-level CAN Objects. Thus, you can use it to start all higher-level network communication simultaneously.
NC_OP_STOP (80000002 hex)	N/A (ignored)	Transitions network interface from started state to stopped state. If network interface is already stopped, this operation has no effect. When a network interface is stopped, it is not communicating on the network. The stop action clears all entries from the read queue of the Network Interface Object. When you execute NC_OP_STOP on a running CAN Network Interface Object, NI-CAN propagates it upward to all open higher-level CAN Objects.
NC_OP_RESET (80000003 hex)	N/A (ignored)	Resets network interface. Stops network interface, then clears all entries from read and write queues. NC_OP_RESET is propagated up to all open higher-level CAN Objects.
NC_OP_RTSSI_OUT (80000004 hex)	N/A (ignored)	Output a pulse or toggle on the RTSSI line depending upon the NC_ATTR_RTSSI_SIG_BEHAV. The NC_OP_RTSSI_OUT action is not supported on the 847x or 847x with Sync series hardware.

## CAN Object

All actions performed on a CAN Object affect that CAN Object alone, and do not affect other CAN Objects or communication as a whole.

Table 11-4 describes the actions supported by the CAN Object.

**Table 11-4.** Actions Supported by the CAN Object

<b>Opcode</b>	<b>Param</b>	<b>Description</b>
NC_OP_START (80000001 hex)	N/A (ignored)	Transitions the CAN Object from stopped (idle) state to started (running) state. If the CAN Object is already started, this operation has no effect.
NC_OP_STOP (80000002 hex)	N/A (ignored)	Stops the CAN Object. For example, if the CAN Object is configured to transmit data frames periodically, this action stops the periodic transmissions. This action will also clear all entries from the read queue.
NC_OP_RESET (80000003 hex)	N/A (ignored)	Resets the CAN Object. Stops the CAN Object, then clears all entries from read and write queues.
NC_OP_RTSI_OUT (80000004 hex)	N/A (ignored)	Output a pulse or toggle on the RTSI line depending upon the NC_ATTR_RTSI_SIG_BEHAV attribute.

## ncCloseObject

---

### Purpose

Close an object.

### Format

```
NCTYPE_STATUS ncCloseObject
(
    NCTYPE_OBJH ObjHandle);
```

### Input

`ObjHandle`  
Object handle.

### Output

#### Return Value

Status of the function call, returned as a signed 32-bit integer. Zero means the function executed successfully. Negative specifies an error, meaning the function did not perform expected behavior. Positive specifies a warning, meaning the function performed as expected, but a condition arose that might require attention. For more information, refer to [ncStatusToString](#).

### Description

`ncCloseObject` closes an object when it no longer needs to be in use, such as when the application is about to exit. When an object is closed, NI-CAN stops all pending operations and clears RTSI configuration for the object, and you can no longer use the `ObjHandle` in the application.

### Network Interface Object

`ObjHandle` refers to an open CAN or LIN Network Interface Object.

### CAN Object

`ObjHandle` refers to an open CAN Object.

# ncConfig

---

## Purpose

Configure an object before using it.

## Format

```
NCTYPE_STATUS ncConfig(
    NCTYPE_STRING ObjName,
    NCTYPE_UINT32 NumAttrs,
    NCTYPE_ATTRID_P AttrIdList,
    NCTYPE_UINT32_P AttrValueList);
```

## Input

ObjName

ASCII name of the object to configure.

The 847x and 847x with Sync series LIN interfaces do not support [ncConfig](#).

NumAttrs

Number of configuration attributes.

AttrIdList

List of configuration attribute identifiers.

AttrValueList

List of configuration attribute values.

## Output

### Return Value

Status of the function call, returned as a signed 32-bit integer. Zero means the function executed successfully. Negative specifies an error, meaning the function did not perform expected behavior. Positive specifies a warning, meaning the function performed as expected, but a condition arose that might require attention. For more information, refer to [ncStatusToString](#).



## Description

`ncConfig` initializes the configuration attributes of an object before opening it. The first NI-CAN function in the application will normally be `ncConfig` of the CAN Network Interface Object.

`NumAttr` indicates the number of configuration attributes in `AttrIdList` and `AttrValueList`. `AttrIdList` is an array of attribute IDs, and `AttrValueList` is an array of values. The host data type for each value in `AttrValueList` is `NCTYPE_UINT32`, which all configuration attributes can use.

The Frame API and Channel API cannot use the same CAN network interface simultaneously. If the CAN network interface is already initialized in the Channel API, this function returns an error.

The following sections describe how to use `ncConfig` with the Network Interface and CAN Object. The description for each object specifies the syntax for `ObjName`, plus a description of the commonly used attributes for `AttrIdList`.

## CAN Network Interface Object

`ObjName` is the name of the CAN Network Interface Object to configure. This string uses the syntax “CAN $x$ “, where  $x$  is a decimal number starting at zero that indicates the CAN network interface (CAN0, CAN1, up to CAN63). CAN network interface names are associated with physical CAN ports using the Measurement & Automation Explorer (MAX).

The special `ObjName` values “CAN256” and “CAN257” refer to virtual interfaces. For virtual interfaces, the only valid attribute is `NC_ATTR_START_ON_OPEN`. All other attributes in the `AttrIdList` are ignored. The mask and comparator attributes are always zero for virtual interfaces (receive all frames).

For more information on usage of virtual interfaces, refer to the [Frame to Channel Conversion](#) section of Chapter 6, [Using the Channel API](#).

The following attribute IDs are commonly used for CAN Network Interface Object configuration.

For the 847 $x$  and 847 $x$  with Sync series CAN interfaces, only `NC_ATTR_START_ON_OPEN` and `NC_ATTR_BAUD_RATE` are valid configuration attributes. All other configuration attributes are ignored.

### `NC_ATTR_BAUD_RATE` (Baud Rate)

Baud Rate is the baud rate to use for communication. Common baud rates are supported, including 33333, 83333, 100000, 125000, 250000, 500000, and 1000000. If you are familiar with the Bit Timing registers used in CAN controllers, you can use a special hexadecimal baud rate

of 0x8000zzyy, where yy is the desired value for register 0 (BTR0), and zz is the desired value for register 1 (BTR1) of the CAN controller.

#### NC\_ATTR\_CAN\_COMP\_STD (Standard Comparator)

`Standard Comparator` is the CAN arbitration ID for the standard (11-bit) frame comparator. For information on how this attribute is used to filter received frames for the Network Interface, refer to the `NC_ATTR_CAN_MASK_STD` (Standard Mask) attribute.

If you intend to open the Network Interface, most applications can set this attribute and the `Standard Mask` to 0 in order to receive all standard frames.

If you intend to use CAN Objects as the sole means of receiving standard frames from the network, you should disable all standard frame reception in the Network Interface by setting this attribute to the special value CFFFFFFF hex. With this setting, the Network Interface is best able to filter out incoming standard frames except those handled by CAN Objects.

#### NC\_ATTR\_CAN\_COMP\_XTD (Extended Comparator)

`Extended Comparator` is the CAN arbitration ID for the extended (29-bit) frame comparator. For information on how this attribute is used to filter extended frames for the Network Interface, refer to the `NC_ATTR_CAN_MASK_XTD` (Extended Mask) attribute.

If you intend to open the Network Interface, most applications can set this attribute and the `Extended Mask` to 0 in order to receive all extended frames.

If you intend to use CAN Objects as the sole means of receiving extended frames from the network, you should disable all extended frame reception in the Network Interface by setting this attribute to the special value CFFFFFFF hex. With this setting, the Network Interface is best able to filter out incoming extended frames except those handled by CAN Objects.

#### NC\_ATTR\_CAN\_MASK\_STD (Standard Mask)

`Standard Mask` is the bitmask used in conjunction with the `Standard Comparator` attribute for filtration of incoming standard (11-bit) CAN frames. For each bit set in the mask, NI-CAN compares the corresponding bit in the `Standard Comparator` to the arbitration ID of the received frame. If the mask/comparator matches, the frame is stored in the Network Interface queue, otherwise it is discarded. Bits in the mask that are clear are treated as don't-cares. For example, hex

00000700 means to compare only the upper 3 bits of the 11-bit standard ID.

If you set the `Standard Comparator` to CFFFFFFF hex, this attribute is ignored, because all standard frame reception is disabled for the Network Interface.

Most applications can set this attribute and the `Standard Comparator` to 0 to receive all standard frames. This is particularly advisable for Series 2 hardware, because the Philips SJA1000 CAN controller does not support distinct filters for standard and extended IDs. For Series 2, nonzero values for this attribute are implemented in software, as an additional filter applied after the Series 2 Filter Mode. When you set this attribute to zero for Series 2, filtering is optimized to use only the Series 2 Filter Mode attribute for the SJA1000.

#### NC\_ATTR\_CAN\_MASK\_XTD (Extended Mask)

`Extended Mask` is the bitmask used in conjunction with the `Extended Comparator` attribute for filtration of incoming extended (29-bit) CAN frames. For each bit set in the mask, NI-CAN compares the corresponding bit in the `Extended Comparator` to the arbitration ID of the received frame. If the mask/comparator matches, the frame is stored in the Network Interface queue, otherwise it is discarded. Bits in the mask that are clear are treated as don't-cares. For example, hex 1F000000 means to compare only the upper 5 bits of the 29-bit extended ID.

If you set the `Extended Comparator` to CFFFFFFF hex, this attribute is ignored, because all extended frame reception is disabled for the Network Interface.

Most applications can set this attribute and the `Extended Comparator` to 0 to receive all extended frames. This is particularly advisable for Series 2 hardware, because the Philips SJA1000 CAN controller does not support distinct filters for standard and extended IDs. For Series 2, nonzero values for this attribute are implemented in software, as an additional filter applied after the Series 2 Filter Mode. When you set this attribute to zero for Series 2, filtering is optimized to use only the Series 2 Filter Mode attribute for the SJA1000.

#### NC\_ATTR\_LISTEN\_ONLY (Listen Only)

`Listen Only` specifies whether to use the listen only feature of the Philips SJA1000 CAN controller.

`NC_False` disables listen only mode (default). Received frames are ACKnowledged, and frames can be transmitted using `ncWrite`.

`NC_True` enables listen only mode. The Network Interface and CAN Objects can only receive frames. The interface does not transmit on the network: no ACKnowledgements are transmitted for received frames, and `ncWrite` will return an error. The Philips SJA1000 CAN controller enters the request/response state when listen only is enabled.

The listen only mode is not available on the Intel 82527 CAN controller used by Series 1 CAN hardware. For Series 1 hardware, this attribute must be left out of the `AttrIdList`.

#### `NC_ATTR_NOTIFY_MULT_LEN` (ReadMultiple Size for Notification)

Sets the number of frames used as a threshold for the Read Multiple state. For more information on the Read Multiple state, refer to `ncWaitForState`.

The default value is one half of `Read Queue Length`.

This attribute applies only to Series 1 and Series 2 interfaces.

#### `NC_ATTR_READ_Q_LEN` (Read Queue Length)

`Read Queue Length` is the maximum number of unread frames for the internal read queue of the CAN Network Interface Object. The recommended value is 100.

The internal read queue exists between the CAN hardware and the NI-CAN device driver. This internal read queue holds frames temporarily prior to transfer a larger queue in the NI-CAN device driver. The larger NI-CAN device driver queue grows as needed in order to accommodate high bus loads.

#### `NC_ATTR_SELF_RECEPTION` (Self Reception)

Specifies whether to echo successfully transmitted CAN or LIN frames into the read queue of the Network Interface and/or CAN Objects. Each reception occurs just as if the frame were received from another CAN or LIN device.

For self reception to operate properly, another CAN or LIN device node must receive and acknowledge each transmit. If a transmitted frame is not successfully acknowledged, it is not echoed into the read queue.

`NC_False` disables Self Reception mode (default). Transmitted frames do not appear in read queues.

`NC_True` enables Self Reception mode. Transmitted frames appear in read queues as if they were received from another CAN or LIN device.

The Self Reception mode is not available on the Intel 82527 CAN controller used by Series 1 CAN hardware. For Series 1 hardware, this attribute must be left out of the `AttrIdList`.

#### `NC_ATTR_SERIES2_FILTER_MODE` (Series 2 Filter Mode)

The Philips SJA1000 CAN controller provides sophisticated filtering of received frames. This attribute specifies the filtering mode, which is used in conjunction with the Series 2 Mask and Series 2 Comparator attributes.

This attribute is not supported for Series 1, 847x LIN, or 847x with Sync LIN interfaces (returns error). For Series 1, the Standard Mask/Comparator and Extended Mask/Comparator attributes are programmed directly into the Intel 82527 CAN controller. Use those attributes to specify filtering of received frames on Series 1 hardware.

The Philips SJA1000 does not support distinct standard and extended masking. Therefore, on Series 2 interfaces the Standard Mask/Comparator and Extended Mask/Comparator attributes are implemented in software (for backward compatibility). Since software masking can have an adverse impact on receive performance, National Instruments recommends that you disable software masking for Series 2 interfaces. Disable software masking by specifying don't-care (0) for all four mask/comparator attributes of `ncConfig`.

Since the format of the Series 2 filters is very specific to the Philips SJA1000 CAN controller, National Instruments cannot guarantee compatibility for this attribute on future hardware series. When using this attribute in the application, it is best to get the `NC_ATTR_HW_SERIES` (Series) attribute to verify that the CAN hardware is Series 2, 847x, or 847x with Sync.

The filtering specified by this attribute and the Series 2 Mask/Comparator applies to the CAN Network Interface Object and all CAN Objects for that interface. For example, if you specify filters that discard ID 5, then open a CAN Object to receive ID 5, the CAN Object will not receive data.

The default value for this attribute is

`NC_FILTER_SINGLE_STANDARD`.

This attribute uses the following values:

#### `NC_FILTER_DUAL_EXTENDED` (Dual Extended)

Filter all extended (29-bit) frames using a two separate mask/comparator filters. If either filter matches the frame, it is received. The frame is discarded only when neither filter detects a match.

Figure 11-1 describes the format of the Series 2 Mask and Series 2 Comparator attributes for this filter mode.

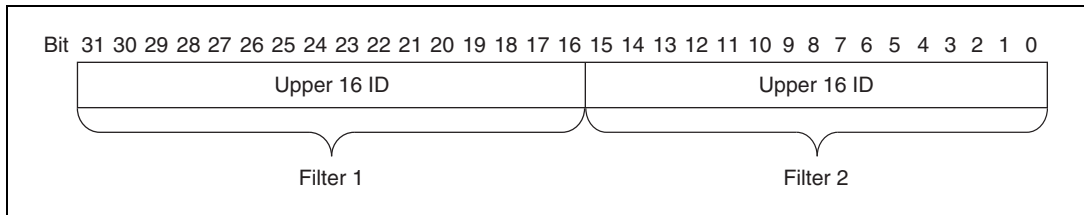

**Figure 11-1.** Mask/Comparator for Dual-Extended Filter Mode

Each Upper 16 ID filter compares the 16 most significant bits of the 29-bit extended ID.

#### NC\_FILTER\_DUAL\_STANDARD (Dual Standard)

Filter all standard (11-bit) frames using a two separate mask/comparator filters. If either filter matches the frame, it is received. The frame is discarded only when neither filter detects a match.

Figure 11-2 describes the format of the Series 2 Mask and Series 2 Comparator attributes for this filter mode.

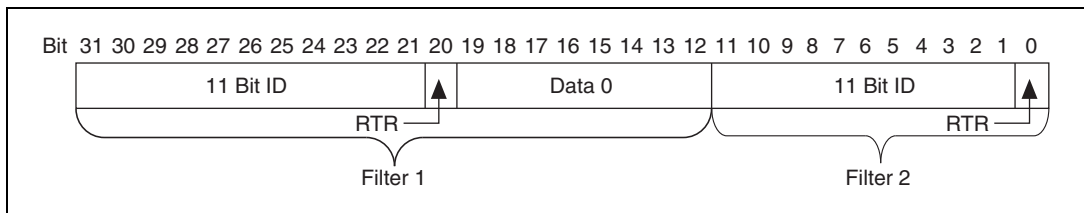

**Figure 11-2.** Mask/Comparator for Dual-Standard Filter Mode

Filter 1 includes the 11 Bit ID, the RTR bit, and the first data byte in the frame. Filter 2 includes the 11 bit ID, and the RTR bit (no data).

#### NC\_FILTER\_SINGLE\_EXTENDED (Single Extended)

Filter all extended (29-bit) frames using a single mask/comparator filter.

Figure 11-3 describes the format of the Series 2 Mask and Series 2 Comparator attributes for this filter mode.

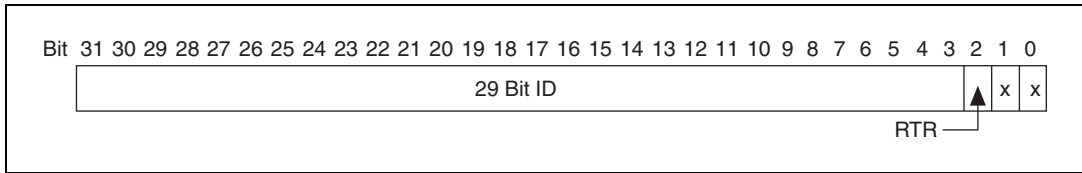

**Figure 11-3.** Mask/Comparator for Single-Extended Filter Mode

The 29 Bit ID compares all 29 bits of extended IDs. The RTR bit determines whether the filter compares remote (1) or data (0) frames. Bits marked as X are reserved, and should be cleared to zero by the application.

`NC_FILTER_SINGLE_STANDARD` (Single Standard)

Filter all standard (11-bit) frames using a single mask/comparator filter.

Figure 11-4 describes the format of the Series 2 Mask and Series 2 Comparator attributes for this filter mode.

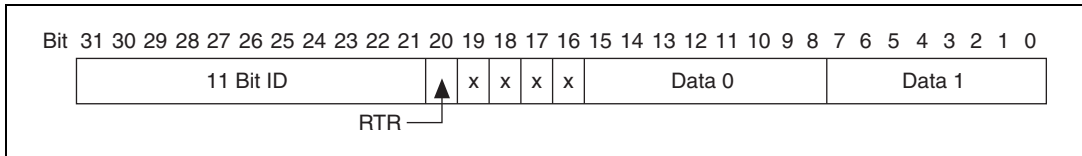

**Figure 11-4.** Mask/Comparator for Single-Standard Filter Mode

The 11 Bit ID compares all 11 bits of standard IDs. The RTR bit determines whether the filter compares remote (1) or data (0) frames. Bits marked as X are reserved, and should be cleared to zero by the application. Data 0 compares the first data byte in the frame, and Data 1 compares the second data byte.

`NC_ATTR_SERIES2_COMP` (Series 2 Comparator)

Specifies the filter comparator for the Philips SJA1000 CAN controller. This attribute is not supported for Series 1, 847x LIN, or 847x with Sync LIN interfaces (returns error).

This attribute specifies a comparator value that is checked against the ID, RTR, and data bits. The `NC_ATTR_SERIES2_MASK` (Series 2 Mask) determines the applicable bits for comparison. The default value of this attribute is zero.

The mapping of bits in this attribute to the ID, RTR, and data bits of incoming frames is determined by the value of the

`NC_ATTR_SERIES2_FILTER_MODE` (Series 2 Filter Mode) attribute. Refer to the `NC_ATTR_SERIES2_FILTER_MODE` (Series 2 Filter Mode) attribute to understand the format of this attribute as well as the Series 2 Mask.

#### `NC_ATTR_SERIES2_MASK` (Series 2 Mask)

Specifies the filter mask for the Philips SJA1000 CAN controller. This attribute is not supported for Series 1, 847x LIN, or 847x with Sync LIN interfaces (returns error).

This attribute specifies a bit mask that determines the ID, RTR, and data bits that are compared. If a bit is clear in the mask, the corresponding bit in the `NC_ATTR_SERIES2_COMP` (Series 2 Comparator) is checked. If a bit in the mask is set, that bit is ignored for the purpose of filtering (don't care). This interpretation is the opposite of the legacy Standard/Extended Mask attributes.

The default value of this attribute is hex FFFFFFFF, which means that all frames are received.

The mapping of bits in this attribute to the ID, RTR, and data bits of incoming frames is determined by the value of the `NC_ATTR_SERIES2_FILTER_MODE` (Series 2 Filter Mode) attribute. Refer to `NC_ATTR_SERIES2_FILTER_MODE` (Series 2 Filter Mode) to understand the format of this attribute as well as the Series 2 Comparator.

#### `NC_ATTR_SINGLE_SHOT_TX` (Single Shot Transmit)

Specifies whether to retry failed CAN frame transmissions (Series 2, 847x CAN, and 847x with Sync CAN interfaces only).

`NC_False` enables retry as defined in the CAN specification (default). If a CAN frame is not transmitted successfully, the CAN controller will immediately retry.

`NC_True` enables single-shot transmit behavior (no retry). If a CAN frame is not transmitted successfully, the CAN controller will not retry.

For Series 1, 847x LIN, and 847x with Sync interfaces, this attribute must be left out of the `AttrIdList`.

#### `NC_ATTR_START_ON_OPEN` (Start On Open)

`Start On Open` indicates whether communication starts for the CAN Network Interface Object (and all applicable CAN Objects) immediately upon opening the object with `ncOpenObject`.

For Series 1 and Series 2 interfaces, the default is `NC_True` (1), which starts communication when `ncOpenObject` is called. If you set



Start On Open to `NC_False` (0), you can call `ncSetAttribute` after opening the interface, then `ncAction` to start communication. You can use the `ncSetAttribute` function to set attributes that are not contained within the `ncConfig` function.

For 847x interfaces, the default is `NC_False` (0).

#### `NC_ATTR_WRITE_Q_LEN` (Write Queue Length)

Write Queue Length is the maximum number of frames for the internal write queue of the CAN Network Interface Object awaiting transmission. The recommended value is 10.

The internal write queue exists between the CAN hardware and the NI-CAN driver. This internal write queue holds frames temporarily prior to transfer to CAN hardware from a larger queue in the NI-CAN device driver.

For more information on writing to the CAN Network Interface object, refer to `ncWriteMult`.

The following attribute ID is used to enable logging of transceiver faults.

#### `NC_ATTR_LOG_COMM_ERRS` (Log Comm Warnings)

Log Comm Warnings specifies whether to log communication warnings (including transceiver faults) to the Network Interface read queue.

When set to `NC_False` (default), the Network Interface reports CAN communication warnings (including transceiver faults) in the return status of read functions. For more information, refer to `ncReadMult`.

When set to `NC_True`, the Network Interface reports CAN communication warnings (including transceiver faults) by storing a special frame in the read queue. The communication warnings are not reported in the return status. For more information on communication warnings and errors, refer to `ncReadMult`. The special communication warning frame uses the following format:

Arbitration ID: Error/warning ID (refer to `ncReadMult`)

Timestamp: Time when error/warning occurred

IsRemote: 2

DataLength: 0

Data: N/A (ignore)

When calling `ncRead` or `ncReadMult` to read frames from the Network Interface, you typically use the `IsRemote` field to

differentiate communications warnings from CAN frames. Refer to [ncReadMult](#) for more information.

RTSI is a bus that interconnects National Instruments DAQ, IMAQ, Motion, and CAN boards. This feature allows synchronization of DAQ, IMAQ, Motion, and CAN boards by allowing exchange of timing signals. Using RTSI, a device (board) can control one or more slave devices.

The following attribute IDs are used to enable RTSI synchronization between two or more National Instruments cards:

#### NC\_ATTR\_RTSI\_MODE (RTSIMode)

RTSI Mode specifies the behavior of the Network Interface with respect to RTSI, including whether the RTSI signal is an input or output:

##### NC\_RTSI\_NONE

Disables RTSI behavior for the Network Interface (default). All other RTSI attributes are ignored.

##### NC\_RTSI\_OUT\_ACTION\_ONLY

The Network Interface will output the RTSI signal whenever the [ncAction](#) function is called with the `OpCode` value set to `NC_OP_RTSI_OUT`. This RTSI mode can be used to manually toggle/pulse a RTSI output within the application.

##### NC\_RTSI\_OUT\_ON\_RX

The Network Interface will output the RTSI signal whenever a CAN frame is stored in the read queue.

If the interface is Series 2, NI-CAN connects a terminal of the Philips SJA1000 CAN controller to the RTSI output. This hardware connection provides jitter in the nanoseconds range, enabling triggering of external oscilloscopes and so on.

##### NC\_RTSI\_OUT\_ON\_TX

The Network Interface will output the RTSI signal whenever a CAN frame is successfully transmitted from the write queue.

##### NC\_RTSI\_TIME\_ON\_IN

When the RTSI input transitions from low to high, a timestamp is measured and stored in the read queue of the Network Interface. The special RTSI frame uses the following format:

Arbitration ID: 40000001 hex

Timestamp: Time when RTSI input transitioned from low to high

IsRemote: 3 (NC\_FRMTYPE\_RTSI)

`DataLength`: RTSI signal detected (`RTSI_Signal`)

`Data`: N/A (ignore)

When calling `ncRead` or `ncReadMult` to read frames from the Network Interface, use the `IsRemote` field to differentiate RTSI timestamps from CAN frames. Refer to `ncReadMult` for more information.

#### `NC_RTSTX_ON_IN`

The Network Interface will transmit a frame from its write queue when the RTSI input transitions from low to high. To begin transmission, at least one data frame must be written using `ncWrite`. If the write queue becomes empty due to frame transmissions, the last frame will be retransmitted on each RTSI pulse until another frame is provided using `ncWrite`.

#### `NC_ATTR_RTSTX_BEHAV` (RTSI Behavior)

`RTSI_Behavior` specifies whether to pulse or toggle a RTSI output. This attribute is ignored when `RTSI_Mode` specifies input (detected low to high):

`RTSI_SIG_PULSE`

Pulse the RTSI output. For Series 1 CAN cards, the pulse is at least 100  $\mu$ s. For Series 2 CAN interfaces, the pulse is at least 100 ns.

`RTSI_SIG_TOGGLE`

If the previous state was high, the output toggles low, then vice-versa.

#### `NC_ATTR_RTSTX_SIGNAL` (RTSI Signal)

`RTSI_Signal` defines the RTSI signal associated with the `RTSI_Mode`. Valid values are 0 to 6, corresponding to RTSI 0 to RTSI 6 on other National Instruments cards.

Series 1 and 2 CAN interfaces each have limitations regarding RTSI. For information on these limitations, refer to the [Valid Combinations of Source/Destination](#) section in the **CAN Connect Terminals.vi** function of the Channel API for LabVIEW.

#### `NC_ATTR_RTSTX_SKIP` (RTSI Skip)

`RTSI_Skip` specifies the number of RTSI inputs (low-to-high transitions) to skip for RTSI input modes. It is ignored for RTSI output modes. For example, for `RTSI_Mode_NC_RTSTX_TIME_ON_IN`, if the RTSI input transitions from low to high every 1 ms, `RTSI_Skip` of 9 means that a timestamp will be stored in the read queue every 10 ms.

## CAN Object

`ObjName` is the name of the CAN Object to configure. This string uses the syntax “CANx::STDy” or “CANx::XTDy”. `CANx` is the name of the CAN network interface that you used for the preceding `ncConfig` function. `STD` indicates that the CAN Object uses a standard (11-bit) arbitration ID. `XTD` indicates that the CAN Object uses an extended (29-bit) arbitration ID. The number `y` specifies the actual arbitration ID of the CAN Object. The number `y` is decimal by default, but you also can use hexadecimal by adding “0x” to the beginning of the number. For example, “CAN0::STD25” indicates standard ID 25 decimal on CAN0, and “CAN1::XTD0x0000F652” indicates extended ID F652 hexadecimal on CAN1.

In order to configure one or more CAN Objects, you must configure the CAN Network Interface Object first.

The special virtual interface names CAN256 and CAN257 are not supported for CAN Objects.

The following attribute IDs are commonly used for CAN Object configuration:

### `NC_ATTR_COMM_TYPE` (Communication Type)

`Communication Type` specifies the behavior of the CAN Object with respect to its ID, including the direction of data transfer:

#### `NC_CAN_COMM_RX_BY_CALL` (Receive By Call Using Remote)

Transmit remote frame for a specific ID by calling `ncWrite`. The CAN Object places the resulting data frame response in the read queue.

`Period` specifies a minimum interval, and `Receive Changes Only` specifies whether to place duplicate data frames into the read queue. `Transmit by Response` is ignored.

#### `NC_CAN_COMM_RX_PERIODIC` (Receive Periodic Using Remote)

Periodically transmit a remote frame for a specific ID in order to receive the associated data frame. Every `Period`, the CAN Object transmits a remote frame, and then places the resulting data frame response in the read queue. If the data frame is not received in response to the transmit remote frame, the periodic transmission is put on hold.

`Period` specifies the periodic rate, and `Receive Changes Only` specifies whether to place duplicate data frames into the read queue. `Transmit by Response` is ignored.

#### `NC_CAN_COMM_RX_UN SOL` (Receive Unsolicited)

Receive data frames for a specific ID.

This type is useful for receiving a few IDs (1-10) into dedicated read queues. For high performance applications (more IDs, fast frame rates), the Network Interface is recommended to receive all IDs.

`Period` specifies a watchdog timeout, and `Receive Changes Only` specifies whether to place duplicate data frames into the read queue. `Transmit by Response` is ignored.

`NC_CAN_COMM_TX_BY_CALL` (Transmit Data By Call)

Transmit data frame when `ncWrite` is called. When `ncWrite` is called quickly, data frames are placed in the write queue for back to back transmit.

`Period` specifies a minimum interval, and `Transmit by Response` specifies whether to retransmit the previous data frame in response to a remote frame. `Receive Changes Only` is ignored.

`NC_CAN_COMM_TX_PERIODIC` (Transmit Data Periodically)

Periodically transmit data frame for a specific ID. When the CAN Object transmits the last entry from the write queue, that entry is used every period until you provide a new data frame using `ncWrite`. If you keep the write queue filled with unique data, this behavior allows you to ensure that each period transmits a unique data frame.

If the write queue is empty when communication starts, the first periodic transmit does not occur until you provide the first data frame with `ncWrite`.

`Period` specifies the periodic rate, and `Transmit by Response` specifies whether to transmit the previous period data in response to a remote frame. If `Transmit by Response` is true, the data from the previous (periodic) transmit will be retransmitted in case a remote frame is received, even if there are frames pending in the write buffer. `Receive Changes Only` is ignored.

`NC_CAN_COMM_TX_RESP_ONLY` (Transmit By Response Only)

Transmit data frame for a specific ID only in response to a received remote frame. When you call `ncWrite`, the data is placed in the write queue, and remains there until a remote frame is received. The number of objects for the communication type usable at the same time is limited to 12.

`Period` specifies a watchdog timeout. `Transmit by Response` is assumed as True regardless of the attribute setting. `Receive Changes Only` is ignored.

`NC_CAN_COMM_TX_WAVEFORM` (Transmit Periodic Waveform)

Transmit a fixed sequence of data frames over and over, one data frame every `Period`.

The following steps describe typical usage of this type:

1. Configure CAN Network Interface Object with `Start On Open` `False`, then open the Network Interface.
2. Configure the CAN Object as Transmit Periodic Waveform and a nonzero `Write Queue Length`, then open the CAN Object.
3. Call `ncWrite` for the CAN Object, once for every entry specified for the `Write Queue Length`.
4. Use `ncAction` to start the Network Interface (not the CAN Object). The CAN Object transmits the first frame in the write queue, then waits the specified period, then transmits the second frame, and so on. After the last frame is transmitted, the CAN Objects waits the specified period, then transmits the first frame again.

If you need to change the waveform contents at runtime, or if you need to transmit very large waveforms (more than 100 frames), we recommend using the `NC_CAN_COMM_TX_PERIODIC` type. Using that type, you can write frames to the Write Queue until full (overflow error), then wait some time for a few frames to transmit, then continue writing new frames.

This communication type has the following limitations:

- `Write Queue Length` must be greater than zero.
- You must write exactly `Write Queue Length` values before starting communication (no less).
- Once communication is started, you cannot write additional values.

`Period` specifies the periodic rate. `Transmit by Response` and `Receive Changes Only` are ignored.

`NC_ATTR_DATA_LEN` (`DataLength`)

`Data Length` specifies the number of bytes in the data frames for this CAN Object ID. This number is placed in the Data Length Code (DLC) of all transmitted data frames and remote frames for the CAN Object. This is also the number of data bytes returned from `ncRead` when the communication type indicates receive.

`NC_ATTR_NOTIFY_MULT_LEN` (`ReadMult Size for Notification`)

Sets the number of frames used as a threshold for the Read Multiple state. For more information on the Read Multiple state, refer to [ncWaitForState](#).

The default value is one half of Read Queue Length.

#### NC\_ATTR\_PERIOD (Period)

Period specifies the rate of periodic behavior in milliseconds.

The behavior depends on the Communication Type as follows:

NC\_CAN\_COMM\_RX\_BY\_CALL

Period specifies a minimum interval between subsequent transmissions. Even if [ncWrite](#) is called very frequently, frames are transmitted on the network at a rate no more than Period. Setting Period to zero disables the minimum interval timer.

NC\_CAN\_COMM\_RX\_PERIODIC

NC\_CAN\_COMM\_RX\_UNSOL

Period specifies the time between subsequent transmissions, and must be set greater than zero.

NC\_CAN\_COMM\_TX\_BY\_CALL

NC\_CAN\_COMM\_TX\_PERIODIC

NC\_CAN\_COMM\_TX\_RESP\_ONLY

Period specifies a watchdog timeout. If a frame is not received at least once every period, a timeout error is returned. Setting Period to zero disables the watchdog timer.

NC\_CAN\_COMM\_TX\_WAVEFORM

#### NC\_ATTR\_READ\_Q\_LEN (Read Queue Length)

Read Queue Length is the maximum number of unread frames for the read queue of the CAN Object. For more information, refer to [ncRead](#).

If Communication Type is set to receive data, a typical value is 10.

If Communication Type is set to transmit data, a typical value is 0.

#### NC\_ATTR\_RX\_CHANGES\_ONLY (Receive Changes Only)

Receive Changes Only applies only to Communication Type selections in which the CAN Object receives data frames (ignored for other types). For those configurations, Receive Changes Only specifies whether duplicated data should be placed in the read queue. When set to `NC_False` (default), all data frames for the CAN Object ID are placed in the read queue. When set to `NC_True`, data frames are

placed into the read queue only if the data bytes differ from the previously received data bytes.

This attribute has no effect on the usage of a watchdog timeout for the CAN Object. For example, if this attribute is `NC_True` and you also specify a watchdog timeout, NI-CAN restarts the watchdog timer every time it receives a data frame for the CAN Object ID, regardless of whether the data differs from the previous frame in the read queue.

#### NC\_ATTR\_TX\_RESPONSE (Transmit By Response)

Transmit By Response applies only to Communication Type of Transmit Data by Call and Transmit Data Periodically (ignored for other types). For those configurations, Transmit By Response specifies whether the CAN Object should automatically respond with the previously transmitted data frame when it receives a remote frame. When set to `NC_False` (default), the CAN Object transmits data frames only as configured, and ignores all remote frames for its ID. When set to `NC_True`, the CAN Object responds to incoming remote frames.

#### NC\_ATTR\_WRITE\_Q\_LEN (Write Queue Length)

Write Queue Length is the maximum number of frames for the write queue of the CAN Object awaiting transmission. For more information, refer to [ncWrite](#).

If Communication Type is set to receive data, a typical value is 0. If Communication Type is set to transmit data, a typical value is 10.

RTSI is a bus that interconnects National Instruments DAQ, IMAQ, Motion, and CAN boards. This feature allows synchronization of DAQ, IMAQ, Motion, and CAN boards by allowing exchange of timing signals. Using RTSI, a device (board) can control one or more slave devices.

The following attribute IDs are used to enable RTSI synchronization between two or more National Instruments cards:

#### NC\_ATTR\_RTISI\_FRAME (RTSI Frame)

RTSI Frame specifies a 4-byte pattern used to differentiate RTSI timestamps from CAN data frames. It is provided as a U32, and the high byte is stored as byte 0 from [ncRead](#). For example, AABBCDD hex is returned as AA in byte 0, BB in byte 1, and so on.

This attribute is used only for RTSI Mode `NC_RTISI_TIME_ON_IN`. It is ignored for all other RTSI Mode values.



## NC\_ATTR\_RTISI\_MODE (RTSIMode)

RTSI Mode specifies the behavior of the CAN Object with respect to RTSI, including whether the RTSI signal is an input or output:

NC\_RTISI\_NONE

Disables RTSI behavior for the CAN Object (default). All other RTSI attributes are ignored.

NC\_RTISI\_OUT\_ACTION\_ONLY

The CAN Object will output the RTSI signal whenever the `ncAction` function is called with `Opcode NC_OP_RTISI_OUT`. This RTSI mode can be used to manually toggle/pulse a RTSI output within the application.

NC\_RTISI\_OUT\_ON\_RX

The CAN Object will output the RTSI signal whenever a CAN frame is stored in its read queue.

In order to use this RTSI Mode, you must configure the CAN Object Communication Type to Receive Unsolicited.

NC\_RTISI\_OUT\_ON\_TX

The CAN Object will output the RTSI signal whenever a CAN frame is successfully transmitted.

In order to use this RTSI Mode, you must configure the CAN Object Communication Type to either Transmit Data by Call, Transmit Data Periodically, or Transmit Periodic Waveform.

NC\_RTISI\_TIME\_ON\_IN

When the RTSI input transitions from low to high, a timestamp is measured and stored in the read queue of the CAN Object. The special RTSI frame uses the following format:

Timestamp: Time when RTSI input transitioned from low to high.

Data: User-defined 4 byte data pattern (refer to the `NC_ATTR_RTISI_FRAME` (RTSI Frame) attribute for details).

NC\_RTISI\_TX\_ON\_IN

The CAN Object will transmit a frame from its write queue when the RTSI input transitions from low to high. To begin transmission, at least one data frame must be written using `ncWrite`. If the write queue becomes empty due to frame transmissions, the last frame will be retransmitted on each RTSI pulse until another frame is provided using `ncWrite`.

In order to use this RTSI Mode, you must configure the CAN Object Communication Type to either Transmit Data by Call, Transmit Data Periodically, or Transmit Periodic Waveform. The Period attribute is ignored when this RTSI mode is selected.

#### NC\_ATTR\_RTISI\_SIG\_BEHAV (RTSI Behavior)

RTSI Behavior specifies whether to pulse or toggle a RTSI output. This attribute is ignored when RTSI Mode specifies input (detected low to high):

RTSI\_SIG\_PULSE

Pulse the RTSI output. For Series 1 CAN cards, the pulse is at least 100  $\mu$ s. For Series 2 CAN cards, the pulse is at least 100 ns.

RTSI\_SIG\_TOGGLE

If the previous state was high, the output toggles low, then vice-versa.

#### NC\_ATTR\_RTISI\_SIGNAL (RTSI Signal)

RTSI Signal defines the RTSI signal associated with the RTSI Mode. Valid values are 0 to 6, corresponding to RTSI0 to RTSI6 on other National Instruments cards.

Series 1 and 2 CAN cards each have limitations regarding RTSI. For information on these limitations, refer to [Valid Combinations of Source/Destination](#) in the **CAN Connect Terminals.vi** function of Chapter 7, *Channel API for LabVIEW*.

#### NC\_ATTR\_RTISI\_SKIP (RTSI Skip)

RTSI Skip specifies the number of RTSI inputs (low-to-high transitions) to skip for RTSI input modes. It is ignored for RTSI output modes. For example, for RTSI Mode NC\_RTISI\_TIME\_ON\_IN, if the RTSI input transitions from low to high every 1 ms, RTSI Skip of 9 means that a timestamp will be stored in the read queue every 10 ms.

## Examples of Different Communication Types

Figure 11-5, Figure 11-6, and Figure 11-7 demonstrate how you can use the `Communication Type` attribute for actual network data transfer. Each figure shows two separate NI-CAN applications that are physically connected across a CAN network.

Figure 11-5 shows a CAN Object that periodically transmits data to another CAN Object. The receiving CAN Object can queue up to five data values.

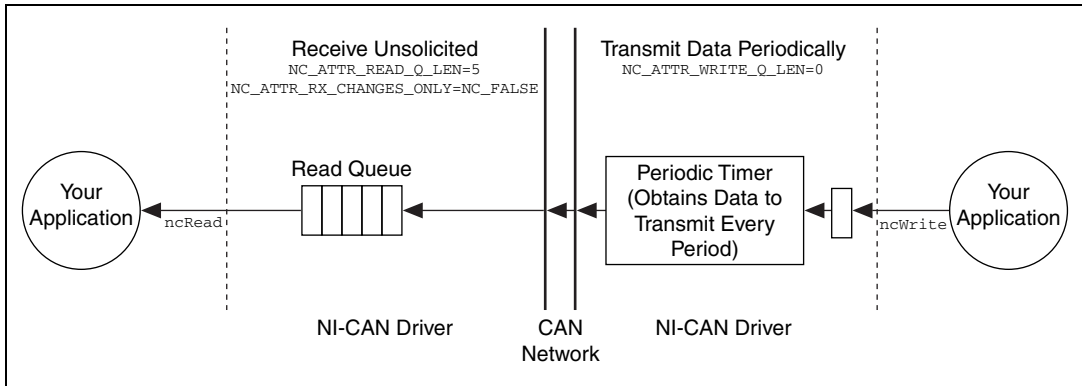

**Figure 11-5.** Example of Periodic Transmission

Figure 11-6 shows a CAN Object that polls data from another CAN Object. NI-CAN transmits the CAN remote frame when you call `ncWrite`.

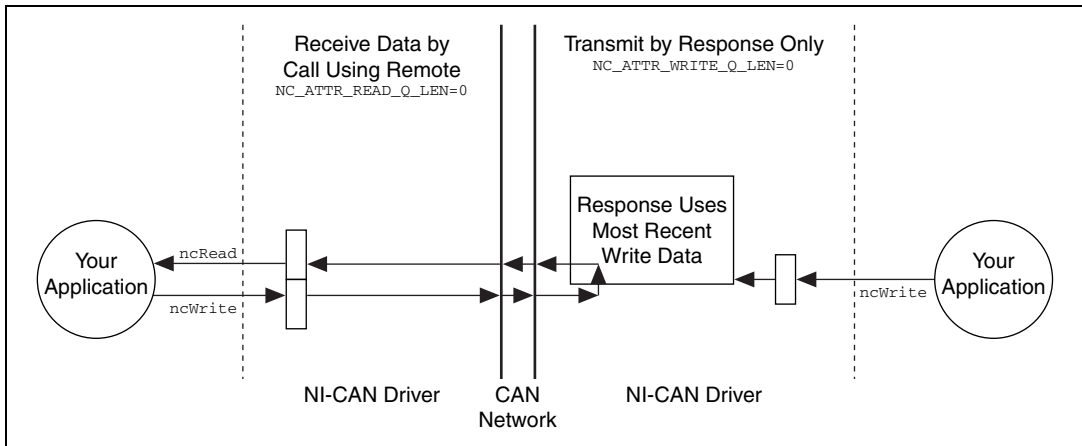

**Figure 11-6.** Example of Polling Remote Data Using `ncWrite`

Figure 11-7 shows a CAN Object that polls data from another CAN Object. NI-CAN transmits the remote frame periodically and places only changed data into the read queue.

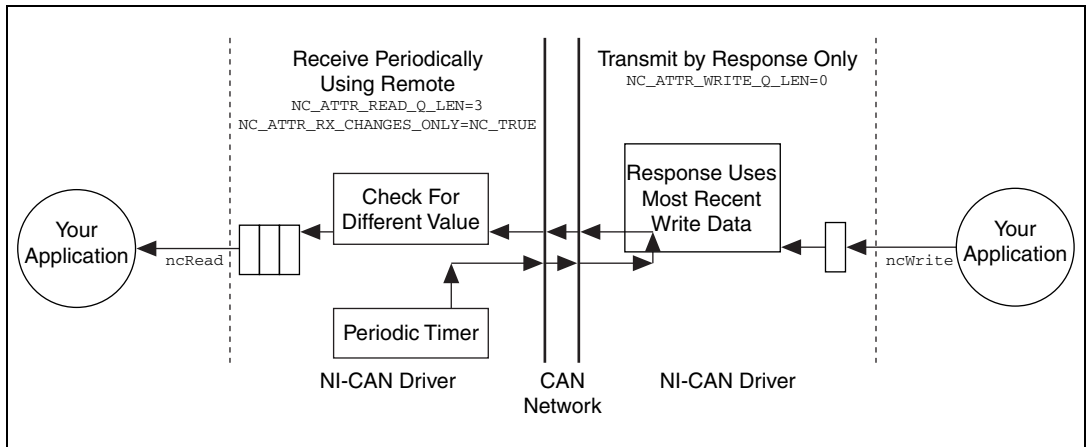

**Figure 11-7.** Example of Periodic Polling of Remote Data

### Example of Periodic Polling of Remote Data

`ncConfig` is not supported for 847x LIN. This function is supported for 847x CAN, but the only two attributes in the CAN Network Interface Config cluster supported are `NC_ATTR_START_ON_OPEN` and `NC_ATTR_BAUD_RATE`.

## ncConnectTerminals

---

### Purpose

Connect terminals in the CAN or LIN hardware.

### Format

```
NCTYPE_STATUS  ncConnectTerminals (
                NCTYPE_OBJH          ObjHandle,
                NCTYPE_UINT32        SourceTerminal,
                NCTYPE_UINT32        DestinationTerminal,
                NCTYPE_UINT32        Modifiers);
```

### Inputs

ObjHandle

The object handle from the previous NI-CAN function. The ObjHandle is originally returned from [ncOpenObject](#).

SourceTerminal

Specifies the connection source.

Once the connection is successfully created, behavior flows from SourceTerminal to DestinationTerminal.

For a list of valid source/destination pairs, refer to the [Valid Combinations of Source/Destination](#) section of this function reference.

The following list describes each value of SourceTerminal:

NC\_SRC\_TERM\_RTISI0 . . . NC\_SRC\_TERM\_RTISI6

Selects a general-purpose RTSI line as source (input) of the connection.

NC\_SRC\_TERM\_RTISI\_CLOCK

Selects the RTSI clock line as source (input) of the connection. This terminal is also RTSI line 7. RTSI7 is dedicated for routing of a timebase (10 MHz or 20 MHz)

The only valid DestinationTerminal for this source is NC\_DEST\_TERM\_MASTER\_TIMEBASE.

For PCI and PXI form factors, this receives a 20 MHz (default) timebase from another CAN or DAQ card. For

example, you can synchronize a CAN and DAQ E Series MIO card by connecting the 20 MHz oscillator (board clock) of the DAQ card to `NC_SRC_TERM_RTSI_CLOCK`, and then connecting `NC_SRC_TERM_RTSI_CLOCK` to `NC_DEST_TERM_MASTER_TIMEBASE` on the CAN card.

For PCMCIA form factor, a 10 MHz timebase is required on `NC_SRC_TERM_RTSI_CLOCK`. For synchronization with a PCMCIA DAQ card, this is done by programming the `FREQOUT` signal of the DAQ card to 10 MHz, then wiring `FREQOUT` to the `NC_SRC_TERM_RTSI_CLOCK` of the CAN card.

For the 847x with Sync series CAN and LIN interfaces, 1 MHz, 10 MHz, and 20 MHz are valid timebases. Refer to Appendix E, *Specifications*, for details on synchronization triggers.

This value does not apply to Series 1.

`NC_SRC_TERM_PXI_STAR`

`NC_SRC_TERM_PXI_STAR` selects the PXI star trigger signal.

Within a PXI chassis, some PXI products can source star trigger from Slot 2 to all higher-numbered slots.

`PXI_Star` enables the PXI CAN card to receive the star trigger when it is in Slot 3 or higher.

This value applies to Series 2 PXI CAN cards only.

`NC_SRC_TERM_PXI_CLK10`

`NC_SRC_TERM_PXI_CLK10` selects the 10 MHz backplane clock.

This routes the 10 MHz PXI backplane clock for use as the timebase for the CAN card. When you use `PXI_Clk10` as the timebase for the CAN card, you must also use `PXI_Clk10` as the timebase for other PXI cards to perform synchronized input/output.

This value applies to Series 2 PXI CAN cards only.

`NC_SRC_TERM_20MHZ_TIMEBASE`

`NC_SRC_TERM_20MHZ_TIMEBASE` selects the 20 MHz oscillator of the CAN card.

The only valid `DestinationTerminal` for this source is `NC_DEST_TERM_RTSI_CLOCK`. This routes the 20 MHz clock of the CAN card for use as a timebase by other NI cards. For example, you can synchronize two CAN cards by

connecting `NC_SRC_TERM_20MHZ_TIMEBASE` to `NC_DEST_TERM_RTSM_CLOCK` on one CAN card, and then connecting `NC_SRC_TERM_RTSM_CLOCK` to `NC_DEST_TERM_MASTER_TIMEBASE` on the other CAN card.

`NC_SRC_TERM_20MHZ_TIMEBASE` applies to the entire CAN or LIN card, including both interfaces of a 2-port CAN card. The CAN card is specified by the `ObjName` input to [ncOpenObject](#).

This value applies to Series 2 PXI or PCI CAN cards only.

This value applies to Series 2 PXI or PCI CAN cards and 847x with Sync interfaces only.

For 847x with Sync series CAN and LIN interfaces the internal oscillator runs at 1 MHz.

`NC_SRC_TERM_10HZ_RESYNC_CLOCK`

`NC_SRC_TERM_10HZ_RESYNC_CLOCK` selects a 10 Hz, 50 percent duty cycle clock. This slow rate is required for resynchronization of Series 1 CAN cards. On each pulse of the resync clock, the other CAN card brings its clock into sync.

By selecting `RTSM-RTSM6` as the `DestinationTerminal`, you route the 10 Hz clock to synchronize with other Series 1 CAN cards. NI-DAQ or NI-DAQmx cards cannot use the 10 Hz resync clock, so this selection is limited to synchronization of two or more CAN cards.

`NC_SRC_TERM_10HZ_RESYNC_CLOCK` applies to the entire CAN card, including both interfaces of a 2-port CAN card. The CAN card is specified by the `ObjName` input to [ncOpenObject](#).

This value applies to Series 1 and Series 2 CAN cards, but is typically used with Series 1 CAN cards only. If all of the CAN cards are Series 2, the 20 MHz timebase is preferable due to the lack of drift. If you are using a mix of Series 1 and Series 2 CAN cards, you must use

`NC_SRC_TERM_10HZ_RESYNC_CLOCK`.

`NC_SRC_TERM_INTF_RECEIVE_EVENT`

`NC_SRC_TERM_INTF_RECEIVE_EVENT` selects the dedicated receive interrupt output on the Philips SJA1000 CAN controller. When a received frame successfully passes the acceptance filter, a pulse with the width of one bit time is

output during the last bit of the end of frame position of the CAN frame. Incoming CAN frames can be filtered using the `NC_ATTR_SERIES2_FILTER_MODE` attribute. The CAN controller is specified by the `ObjName` input to [ncOpenObject](#).

`NC_SRC_TERM_INTF_RECEIVE_EVENT` can be used as the start trigger for other NI cards, or for external instruments.

This value applies to Series 2 cards only.

`NC_SRC_TERM_INTF_TRANSCEIVER_EVENT`

`NC_SRC_TERM_INTF_TRANSCEIVER_EVENT` selects the NERR signal from the CAN transceiver. The Low-Speed/Fault-Tolerant transceiver and the High-Speed transceiver provide the NERR signal. This signal asserts when a fault is detected by the transceiver. The default value of NERR is logic-high, which indicates no error.

The CAN card is specified by the `ObjName` input to [ncOpenObject](#).

This value applies to Series 2 CAN cards only.

`NC_SRC_TERM_START_TRIGGER`

`NC_SRC_TERM_START_TRIGGER` selects the start trigger, the event that starts objects.

The start trigger is the same for all CAN Objects using a given interface, such as the `ObjName` input to [ncOpenObject](#).

In the default (disconnected) state of the

`NC_DEST_TERM_START_TRIGGER` destination, the start trigger occurs when communication begins on the interface.

By selecting `RTSI0-RTSI6` as the `DestinationTerminal`, you route the start trigger of this CAN or LIN card to the start trigger of other CAN, LIN, or DAQ cards. This ensures that sampling begins at the same time on both cards. For example, you can synchronize two CAN cards by routing

`NC_SRC_TERM_START_TRIGGER` as the `SourceTerminal` on one CAN card, and then routing

`NC_DEST_TERM_START_TRIGGER` as the

`DestinationTerminal` on the other CAN card, with both cards using the same RTSI line for the connections.



`DestinationTerminal`

Specifies the destination of the connection.

The following list describes each value of `DestinationTerminal`:

`NC_DEST_TERM_RTSI0... NC_DEST_TERM_RTSI6`

Selects a general-purpose RTSI line as destination (output) of the connection.

`NC_DEST_TERM_RTSI_CLOCK`

Selects the RTSI clock line as destination (output) of the connection. This terminal is also RTSI line 7. RTSI7 is dedicated for routing of a timebase. The CAN card can import a 10 MHz or 20 MHz timebase, but can only export a 20 MHz timebase.

847x with Sync cards can import 1 MHz, 10 MHz, or 20 MHz timebases, but can export only a 1 MHz timebase.

`NC_DEST_TERM_MASTER_TIMEBASE`

`NC_DEST_TERM_MASTER_TIMEBASE` instructs the CAN or LIN card to use the source of the connection as the master timebase. The CAN or LIN card uses this master timebase for input sampling (including timestamps of received messages) as well as periodic output sampling.

For PCI and PXI form factors, you can use

`NC_SRC_TERM_RTSI_CLOCK` as the `SourceTerminal`. By default this receives a 20 MHz timebase from another CAN or DAQ card. For example, you can synchronize a CAN and DAQ E Series MIO card by connecting the 20 MHz oscillator (board clock) of the DAQ card to `RTSI Clock (RTSI7)`, and then connecting `NC_SRC_TERM_RTSI_CLOCK` to `NC_DEST_TERM_MASTER_TIMEBASE` on the CAN card.

To change the **Master Timebase Rate** to 10 MHz, use `ncSetAttribute` to change the

`NC_ATTR_MASTER_TIMEBASE_RATE` attribute.

For PXI form factor, you also can use

`NC_SRC_TERM_PXI_CLK10` as the `SourceTerminal`. This receives the PXI 10 MHz backplane clock for use as the master timebase.

For PCMCIA form factor, you can use

`NC_SRC_TERM_RTSI_CLOCK` as the `SourceTerminal`. Unlike PCI and PXI, the PCMCIA CAN card requires a 10 MHz timebase on `NC_SRC_TERM_RTSI_CLOCK`. For synchronization with a PCMCIA DAQ card, this is done

by programming the `FREQOUT` signal of the DAQ card to 10 MHz, then wiring `FREQOUT` to the `NC_SRC_TERM_RTST_CLOCK` of the CAN card.

For the USB form factor, you can use `RTSI7/RTSI` Clock as the source terminal. The USB hardware automatically senses the incoming clock rate of 1 MHz, 10 MHz, or 20 MHz, so no further configuration is required.

`NC_DEST_TERM_MASTER_TIMEBASE` applies to the entire CAN or LIN card, including both interfaces of a 2-port CAN card. The CAN card is specified by the `ObjName` input to [ncOpenObject](#).

The default (disconnected) state of this destination means the CAN or LIN card uses its local 20 MHz timebase as the master timebase.

`NC_DEST_TERM_10HZ_RESYNC_CLOCK`

`NC_DEST_TERM_10HZ_RESYNC_CLOCK` instructs the CAN card to use a 10 Hz, 50 percent duty cycle clock to resynchronize its local timebase. This slow rate is required for resynchronization of CAN cards. On each low-to-high transition of the resync clock, this CAN card brings its local timebase into sync.

When synchronizing to an E Series MIO card, a typical use of this value is to use `RTSI0-RTSI6` as the `SourceTerminal`, then use `NI-DAQ` or `NI-DAQmx` functions to program Counter 0 of the MIO card to generate a 10 Hz 50 percent duty cycle clock on the `RTSI` line.

When synchronizing to a CAN card, a typical use of this value is to use `RTSI0-RTSI6` as the `SourceTerminal`, then route the `NC_SRC_TERM_10HZ_RESYNC_CLOCK` of the other CAN card as the `SourceTerminal` to the same `RTSI` line.

`NC_DEST_TERM_10HZ_RESYNC_CLOCK` applies to the entire CAN card, including both interfaces of a 2-port CAN card. The CAN card is specified by the `ObjName` input to [ncOpenObject](#).

The default (disconnected) state of this destination means the CAN card does not resynchronize its local timebase.

This value applies to Series 1 and Series 2 CAN cards, but is typically used with Series 1 CAN cards only. If all of the CAN cards are Series 2, the 20 MHz timebase is preferable due to the lack of drift. If you are using a mix of Series 1 and

Series 2 CAN cards, you must use

`NC_DEST_TERM_10HZ_RESYNC_CLOCK.`

`NC_DEST_TERM_START_TRIGGER`

`NC_DEST_TERM_START_TRIGGER` selects the start trigger, the event that begins sampling for tasks. The start trigger occurs on the first low-to-high transition of the source terminal.

The start trigger is the same for all tasks using a given interface, such as the `ObjName` input to `ncOpenObject`.

By selecting `RTSI0-RTSI6`, or `NC_SRC_TERM_PXI_STAR` for PXI hardware, as the `SourceTerminal`, you route the start trigger from another CAN, LIN, or DAQ card. This ensures that sampling begins at the same time on both cards. For example, you can synchronize with an E Series DAQ MIO card by routing the AI start trigger of the MIO card to a RTSI line and then routing the same RTSI line with `NC_DEST_TERM_START_TRIGGER` as the `DestinationTerminal` on the CAN card.

The default (disconnected) state of this destination means the start trigger occurs when communication begins on the interface.

#### Modifiers

Provides optional connection information for certain source/destination pairs. The current release of NI-CAN does not use this information for any source/destination pair, so you must pass `Modifiers` as zero.

## Outputs

### Return Value

The return value indicates the status of the function call as a signed 32-bit integer. Zero means the function executed successfully. A negative value specifies an error, which means the function did not perform the expected behavior. A positive value specifies a warning, which means the function performed as expected, but a condition arose that may require attention.

Use the `ncStatusToString` function of the Frame API to obtain a descriptive string for the return value.

## Description

This VI connects a specific pair of source/destination terminals. One of the terminals is typically a RTSI signal, and the other terminal is an internal terminal in the CAN or LIN hardware. By connecting internal terminals to RTSI, you can synchronize the CAN or LIN hardware with another hardware product such as an NI-DAQ or NI-DAQmx card.

When the final CAN Object for a given port is cleared with `ncCloseObject`, NI-CAN disconnects all terminal connections for that port. Therefore, the `ncDisconnectTerminals` function is not required for most applications. NI-DAQ and NI-DAQmx terminals remain connected after the tasks are cleared, so you must disconnect NI-DAQ/NI-DAQmx terminals manually at the end of the application.

For a list of valid source/destination pairs, refer to the following section.

## Valid Combinations of Source/Destination

The series of the NI CAN hardware determines what combinations of `SourceTerminal` to `DestinationTerminal` are valid. Within Table 11-5, 1 indicates Series 1 hardware, and 2 indicates Series 2 hardware. You can determine the series of the NI CAN hardware by selecting the name of the card within the **Devices and Interfaces»NI-CAN Devices** view in the left pane of MAX.

Series 1 hardware has the following limitations:

- PXI cards do not support RTSI6.
- Signals received from a RTSI source cannot occur faster than 1 kHz. This prevents the card from receiving a 10 MHz or 20 MHz timebase, such as provided by NI E Series MIO hardware.
- Signals received from a RTSI source must be at least 100  $\mu$ s in length to be detected. This prevents the card from receiving triggers in the nanoseconds range, such as the AI trigger provided by NI E Series MIO hardware. Series 2 CAN cards also send RTSI pulses in the nanoseconds range, so Series 1 CAN cards cannot receive RTSI input from Series 2 CAN cards.
- For CAN cards with High-Speed (HS) ports only, four RTSI signals are available for input (source), and four RTSI signals are available for output (destination). This limitation applies to the number of signals per direction, not the RTSI signal number. For example, if you connect RTSI0, RTSI1, RTSI3, and RTSI5 as input, connecting RTSI4 as input will return an error.
- For CAN cards with one or more Low-Speed (LS) ports, two RTSI signals are available for input (source), and three RTSI signals are available for output (destination).

Series 2 hardware has the following limitations:

- For all form factors (PCI, PXI, PCMCIA), the connection of Interface Transceiver Event to a RTSI destination is dependent on the physical port location. If the interface is located on Port 1, you can connect to even-numbered RTSI lines only (RTSI0, RTSI2, RTSI4, RTSI6). If the interface is located on Port 2, you can connect to odd-numbered RTSI lines only (RTSI1, RTSI3, RTSI5). You can determine the location by selecting the name of the interface in MAX.
- PCI cards do not support the PXI\_Star and PXI\_Clk10 terminals, as those signals exist on the PXI backplane.
- PCMCIA cards do not support the 20 MHz Timebase, PXI\_Star, and PXI\_Clk10 terminals. Because 20 MHz Timebase is not supported, you cannot synchronize the timebases of two PCMCIA CAN cards.
- On PCMCIA cards, RTSI4, RTSI5 and RTSI6 are not available.

847x with Sync series hardware has the following limitations:

- No support for RTSI1–RTSI6.
- Because 20 MHz timebase only outputs a 1 MHz signal, you cannot source a timebase to a PCI-CAN device. It can, however, receive a 20 MHz signal from a PCI-CAN device.
- RTSI0 must be connected to the TRIG terminal and RTSI7 must be connected to the CLK terminal. Refer to the *USB-LIN* section of Chapter 3, *NI CAN and LIN Hardware*, for more information on the pinout of the USB-847x with Sync series hardware.

Table 11-5 lists all valid combinations of `SourceTerminal` and `DestinationTerminal`.

**Table 11-5.** Valid combinations of Source/Destination

Source	Destination				
	RTSI0 to RTSI6	RTSI_Clock	Master Timebase	10 Hz Resync Clock	Start Trigger
RTSI0 to RTSI6	—	—	—	1, 2	1, 2, 3
RTSI7/RTSI_Clock	—	—	2, 3	—	—
PXI_Star	—	—	—	—	2
PXI_Clk10	—	—	2	—	—
20 MHz Timebase	—	2, 3	—	—	—

**Table 11-5.** Valid combinations of Source/Destination (Continued)

Source	Destination				
	RTSI0 to RTSI6	RTSI_Clock	Master Timebase	10 Hz Resync Clock	Start Trigger
10 Hz Resync Clock	1, 2	—	—	—	1, 2
Interface Receive Event	2	—	—	—	2
Interface Transceiver Event	2	—	—	—	—
Start Trigger Event	1, 2, 3	—	—	—	—

1—Valid connection for Series 1 hardware

2—Valid connection for Series 2 hardware

3—Valid connection for 847x with Sync series hardware

## ncCreateNotification

---

### Purpose

Create a notification call back for an object.

### Format

```
NCTYPE_STATUS ncCreateNotification(
    NCTYPE_OBJH ObjHandle,
    NCTYPE_STATE DesiredState,
    NCTYPE_UINT32 Timeout,
    NCTYPE_ANY_P RefData,
    NCTYPE_NOTIFY_CALLBACK Callback);
```

### Input

ObjHandle

Object handle. The `ncCreateNotification` function is not supported by the 847x and 847x with Sync series CAN and LIN interfaces.

DesiredState

States for which notification is sent.

Timeout

Length of time to wait in milliseconds.

RefData

Pointer to user-specified reference data.

Callback

Address of the callback function.

### Output

#### Return Value

Status of the function call, returned as a signed 32-bit integer. Zero means the function executed successfully. Negative specifies an error, meaning the function did not perform expected behavior. Positive specifies a warning, meaning the function performed as expected,

but a condition arose that might require attention. For more information, refer to [ncStatusToString](#).

## Description

[ncCreateNotification](#) creates a notification callback for the object specified by `ObjHandle`. The NI-CAN driver uses the notification callback to communicate state changes to the application.

This function is normally used when you want to allow other code to execute while waiting for NI-CAN states, especially when the other code does not call NI-CAN functions. If such background execution is not needed, the [ncWaitForState](#) function offers better overall performance. The [ncWaitForState](#) function cannot be used at the same time as [ncCreateNotification](#).

The functions [ncWaitForState](#) and [ncCreateNotification](#) use the same underlying implementation. Therefore, for each object handle, only one of these functions can be pending at a time. For example, you cannot invoke [ncWaitForState](#) or [ncCreateNotification](#) twice from different threads for the same object. For different object handles, these functions can overlap in execution.

This function is not supported for Visual Basic 6.

Upon successful return from [ncCreateNotification](#), the notification callback is invoked whenever one of the states specified by `DesiredState` occurs in the object, or if an error occurs in the object. If `DesiredState` is zero, notifications are disabled for the object specified by `ObjHandle`. `DesiredState` specifies a bit mask for which notification is desired. You can use a single state alone, or you can OR them together.

`NC_ST_READ_AVAIL` (00000001 hex)

At least one frame is available, which you can obtain using an appropriate read function.

The state is set whenever a frame arrives for the object. The state is cleared when the read queue is empty.

`NC_ST_READ_MULT` (00000008 hex)

A specified number of frames are available, which you can obtain using [ncReadMult](#). The number of frames is one half the `Read Queue Length` by default, but you can change it using the `ReadMult Size for Notification` attribute of [ncSetAttribute](#).

The state is set whenever the specified number of frames are stored in the read queue of the object. The state is cleared when you call the read function, and less than the specified number of frames exist in the read queue.



`NC_ST_REMOTE_WAKEUP` (00000040 hex, Remote Wakeup)

Remote wakeup occurred, and Transceiver Mode (`NC_ATTR_TRANSCEIVER_MODE`) has changed from Sleep to Normal. For more information on remote wakeup, refer to `NC_ATTR_TRANSCEIVER_MODE` (Transceiver Mode).

This state is set when a remote wakeup occurs (end of wakeup frame). This state is not set when the application changes Transceiver Mode from Sleep to Normal (local wakeup).

This state is cleared when:

- You open the Network Interface, such as when the application begins.
- You stop the Network Interface.
- You set the Transceiver Mode, such as each time you set Sleep mode.

For as long as this state is true, the transceiver mode is Normal. The transceiver mode also can be Normal when this state is false, such as when you perform a local wakeup.

`NC_ST_WRITE_MULT` (00000080 hex)

The state is set whenever there is free space in the write queue to accept at least 512 frames to write. The state is cleared when you call the `ncWrite` or `ncWriteMult` function, and less than 512 frames can be accepted to write in the write queue.

This state is valid only on the Network Interface.

`NC_ST_WRITE_SUCCESS` (00000002 hex)

All frames provided with a write function have been successfully transmitted onto the network. Successful transmit means that the frame won arbitration, and was acknowledged by a remote device.

The state is set when the last frame in the write queue is transmitted successfully. The state is cleared when a write function is called.

When communication starts, the `NC_ST_WRITE_SUCCESS` state is true by default.

For CAN Objects, Write Success does not always mean that transmission has stopped. For example, if a CAN Object is configured for Transmit Data Periodically, Write Success occurs when the write queue has been emptied, but periodic transmit of the last frame continues.

The NI-CAN driver waits up to `Timeout` for one of the bits set in `DesiredState` to become set in the attribute `NC_ATTR_STATE`. You can

use the special `Timeout` value `NC_DURATION_INFINITE` to wait indefinitely.

The `Callback` parameter provides the address of a callback function in the application. Within the `Callback` function, you can call any of the NI-CAN functions except `ncCreateNotification` and `ncWaitForState`.

With the `RefData` parameter, you provide a pointer that is sent to all notifications for the given object. This pointer normally provides reference data for use within the `Callback` function. For example, when you create a notification for the `NC_ST_READ_AVAIL` state, `RefData` is often the data pointer that you pass to `ncRead` to read available data. If the callback function does not need reference data, you can set `RefData` to `NULL`.

## Callback Prototype

```
NCTYPE_STATE _NCFUNC_ Callback (NCTYPE_OBJH ObjHandle,
                                NCTYPE_STATE State,
                                NCTYPE_STATUS Status,
                                NCTYPE_ANY_P RefData);
```

## Callback Parameters

`ObjHandle`

Object handle.

`State`

Current state of object.

`Status`

Object status.

`RefData`

Pointer to the reference data.

## Callback Return Value

The value you return from the callback indicates the desired states to re-enable for notification. If you no longer want to receive notifications for the callback, return a value of zero.

If you return a state from the callback, and that state is still set in the `NC_ATTR_STATE` attribute, the callback is invoked again immediately after it returns. For example, if you return `NC_ST_READ_AVAIL` when the read queue has not been emptied, the callback is invoked again.

## Callback Description

In the prototype for `Callback`, `_NCFUNC_` ensures a proper calling scheme between the NI-CAN driver and the callback.

The `Callback` function executes in a separate thread in the process. Therefore, it has access to any process global data, but not to thread local data. If the callback needs to access global data, you must protect that access using synchronization primitives (such as semaphores), because the callback is running in a different thread context. Alternatively, you can avoid the issue of data protection entirely if the callback simply posts a message to the application using the Win32 `PostMessage` function. For complete information on multithreading issues, refer to the Win32 Software Development Kit (SDK) online help.

In LabWindows/CVI, you cannot access User Interface library functions within the callback thread. To defer a callback for User Interface interaction, use the CVI `PostDeferredCall` function. For more information, refer to the LabWindows/CVI documentation.

The `ObjHandle` is the same object handle passed to `ncCreateNotification`. It identifies the object generating the notification, which is useful when you use the same callback function for notifications from multiple objects.

The `State` parameter holds the current state(s) of the object that generated the notification (`NC_ATTR_STATE` attribute). If the `Timeout` passed to `ncCreateNotification` expires before the desired states occur, or if any other error occurs in the object, the NI-CAN driver invokes the callback with `State` equal to zero.

The `Status` parameter holds the current status of the object. If an error occurs, `State` is zero and `Status` holds the error status. The most common notification error occurs when the `Timeout` passed to `ncCreateNotification` expires before the desired states occur (`CanErrFunctionTimeout` status code). If no error is reported, `Status` is `CanSuccess`.

The `RefData` parameter is the same pointer passed to `ncCreateNotification`, and it accesses reference data for the `Callback` function.

## ncDisconnectTerminals

---

### Purpose

Disconnect terminals in the CAN or LIN hardware.

### Format

```
NCTYPE_STATUS  ncDisconnectTerminals(
                NCTYPE_OBJH           ObjectHandle,
                NCTYPE_UINT32         SourceTerminal,
                NCTYPE_UINT32         DestinationTerminal,
                NCTYPE_UINT32         Modifiers);
```

### Inputs

`ObjectHandle`

The object handle from the previous NI-CAN function. The `ObjectHandle` is originally returned from [ncOpenObject](#).

`SourceTerminal`

Specifies the source of the connection.

For a description of values for `SourceTerminal`, refer to [ncConnectTerminals](#).

`DestinationTerminal`

Specifies the destination of the connection.

For a description of values for `DestinationTerminal`, refer to [ncConnectTerminals](#).

`Modifiers`

Provides optional connection information for certain source/destination pairs. The current release of NI-CAN does not use this information for any source/destination pair, so you must pass `Modifiers` as zero.

## Outputs

### Return Value

The return value indicates the status of the function call as a signed 32-bit integer. Zero means the function executed successfully. A negative value specifies an error, which means the function did not perform the expected behavior. A positive value specifies a warning, which means the function performed as expected, but a condition arose that may require attention.

Use the `ncStatusToString` function of the Frame API to obtain a descriptive string for the return value.

## Description

This function disconnects a specific pair of source/destination terminals you previously connected with `ncConnectTerminals`.

When the final CAN Object for a given port is cleared with `ncCloseObject`, NI-CAN disconnects all terminal connections for that port. Therefore, the `ncDisconnectTerminals` function is not required for most applications. You typically use this function to change RTSI connections dynamically while the application is running. First use `ncAction` with the `NC_OP_STOP` opcode to stop all CAN Objects for the port, then use `ncDisconnectTerminals` and `ncConnectTerminals` to adjust RTSI connections, then use `ncAction` with the `NC_OP_START` opcode to start the network interface and restart sampling.

## ncGetAttribute

---

### Purpose

Get the value of an object attribute.

### Format

```
NCTYPE_STATUS ncGetAttribute(
    NCTYPE_OBJH ObjHandle,
    NCTYPE_ATTRID AttrId,
    NCTYPE_UINT32 AttrSize,
    NCTYPE_ANY_P AttrPtr);
```

### Input

`ObjHandle`  
Object handle.

`AttrId`  
Identifier of the attribute to get.

`AttrSize`  
Size of the attribute in bytes.

### Output

`AttrPtr`  
Pointer used to return an attribute value.

### Return Value

Status of the function call, returned as a signed 32-bit integer. Zero means the function executed successfully. Negative specifies an error, meaning the function did not perform expected behavior. Positive specifies a warning, meaning the function performed as expected, but a condition arose that might require attention. For more information, refer to [ncStatusToString](#).

## Description

`ncGetAttribute` gets the value of the attribute specified by `AttrId` from the object specified by `ObjHandle`. Within NI-CAN Objects, you use attributes to access configuration settings, status, and other information about the object, but not data.

`AttrPtr` points to the variable used to receive the attribute value. Its type is undefined so that you can use the appropriate host data type for `AttrId`. `AttrSize` indicates the size of the variable that `AttrPtr` points to. `AttrSize` is typically 4, and `AttrPtr` references a 32-bit unsigned integer.

You can get any value of `AttrId` mentioned in `ncConfig` using `ncGetAttribute`. The following list describes other `AttrId` you can get using `ncGetAttribute`:

### NC\_ATTR\_ABS\_TIME (Absolute Timestamp)

Returns the absolute timestamp value. The timestamp format is a 64-bit unsigned integer compatible with the Win32 FILETIME type (NCTYPE\_ABS\_TIME). This absolute time is kept in a Coordinated Universal Time (UTC) format. UTC time is loosely defined as the current date and time of day in Greenwich, England. Microsoft defines its UTC time (FILETIME) as a 64-bit counter of 100 ns intervals that have elapsed since 12:00 a.m., January 1, 1601.

Since the timestamp returned by `ncRead` (and this attribute) is compatible with Win32 FILETIME, you can pass it into the Win32 `FileTimeToLocalFileTime` function to convert it to the local time zone, then pass the resulting local time to the `Win32FileTimeToSystemTime` function to convert to the Win32 SYSTEMTIME type. SYSTEMTIME is a struct with fields for year, month, day, and so on. For more information on Win32 time types and functions, refer to the Microsoft Win32 documentation.

Since the absolute timestamp type is 64 bits (NCTYPE\_ABS\_TIME), you must use `AttrSize` of 8.

### NC\_ATTR\_BAUD\_RATE (Baud Rate)

Returns the value of `NC_ATTR_BAUD_RATE` as configured with `ncConfig` or `ncSetAttribute`.

### NC\_ATTR\_HW\_FORMFACTOR (Form Factor)

Returns the form factor of the card on which the Network Interface or CAN Object is located.

The returned Form Factor is an enumeration.

NC_HW_FORMFACTOR_PCI	PCI
NC_HW_FORMFACTOR_PXI	PXI
NC_HW_FORMFACTOR_PCMCIA	PCMCIA
NC_HW_FORMFACTOR_AT	AT
NC_HW_FORMFACTOR_USB	USB

#### NC\_ATTR\_HW\_SERIAL\_NUM (Serial Number)

Returns the serial number of the card on which the Network Interface or CAN Object is located.

#### NC\_ATTR\_HW\_SERIES (Series)

Returns the series of the card on which the Network Interface or CAN Object is located.

Series 1 hardware products use the Intel 82527 CAN controller.

Series 2 hardware products use the Philips SJA1000 CAN controller, plus improved RTSI synchronization features.

The 847x and 847x with Sync series CAN hardware products use the Philips SJA1000 CAN controller. The 847x and 847x with Sync series LIN hardware products use the AMTEL ATA6625 LIN controller.

The 847x with Sync series hardware products add synchronization features to the 847x hardware products.

The returned Series is an enumeration.

NC_HW_SERIES_1	Series 1
NC_HW_SERIES_2	Series 2
NC_HW_SERIES_847x	847x
NC_HW_SERIES_847x_with_Sync	847x with Sync

#### NC\_ATTR\_INTERFACE\_NUM (Interface Number)

Returns the interface number of the port on which the Network Interface or CAN Object is located.

This is the same number that you used in the `ObjName` string of the previous `ncConfig` and `ncOpenObject` functions.



**NC\_ATTR\_LIN\_CHECKSUM\_TYPE (LIN Checksum Type)**

Returns the value of the `NC_ATTR_LIN_CHECKSUM_TYPE` attribute as configured with `ncSetAttribute`.

**NC\_ATTR\_LIN\_ENABLE\_DLC\_CHECK (LIN Enable DLC Check)**

Returns the value of the `NC_ATTR_LIN_ENABLE_DLC_CHECK` attribute as configured with `ncSetAttribute`.

**NC\_ATTR\_LIN\_LOG\_WAKEUP (LIN Log Wakeup)**

Returns the value of the `NC_ATTR_LIN_LOG_WAKEUP` attribute as configured with `ncSetAttribute`.

**NC\_ATTR\_LIN\_RESPONSE\_TIMEOUT (LIN Response Timeout)**

Returns the value of the `NC_ATTR_LIN_RESPONSE_TIMEOUT` attribute as configured with `ncSetAttribute`.

**NC\_ATTR\_LIN\_SLEEP (LIN Sleep)**

Returns the value of the `NC_ATTR_LIN_SLEEP` attribute. This attribute may be updated by the user with `ncSetAttribute` or by the reception of a wakeup signal on the LIN bus.

**NC\_ATTR\_LISTEN\_ONLY (Listen Only)**

Returns the `NC_ATTR_LISTEN_ONLY` attribute as configured with `ncConfig`.

**NC\_ATTR\_LOG\_BUS\_ERRORS (Log Bus Errors?)**

Returns the value of the `NC_ATTR_LOG_BUS_ERRORS` attribute as configured with `ncSetAttribute`.

**NC\_ATTR\_LOG\_COMM\_ERRS (Log Comm Warnings)**

Returns TRUE or FALSE depending on whether communication warnings (including transceiver faults) were logged to the Network Interface read queue. For more information, refer to this attribute in `ncConfig`.

**NC\_ATTR\_LOG\_START\_TRIGGER (Log Start Trigger)**

Returns the `NC_ATTR_LOG_START_TRIGGER` attribute as configured with `ncSetAttribute`.

**NC\_ATTR\_LOG\_TRANSCEIVER\_FAULTS (Log Transceiver Faults?)**

Returns the value of the `NC_ATTR_LOG_TRANSCEIVER_FAULTS` attribute as configured with `ncSetAttribute`.

**NC\_ATTR\_MASTER\_TIMEBASE\_RATE (Master Timebase Rate)**

Returns the present Master Timebase Rate in MHz, programmed into the CAN Series 1 or Series 2 hardware. For PCMCIA, this attribute will always return 10 MHz.

For the 847x with Sync series CAN and LIN hardware, this attribute returns the value that was automatically detected.

**NC\_ATTR\_NOTIFY\_MULT\_LEN (ReadMult Size for Notification)**

Returns the number of frames used as a threshold for the Read Multiple state. For more information, refer to this attribute in [ncSetAttribute](#).

**NC\_ATTR\_PROTOCOL\_VERSION (Protocol Version)**

For NI-CAN, this returns 02000200 hex, which corresponds to version 2.0B of the Bosch CAN specifications. For more information on the encoding of the version, refer to the [NC\\_ATTR\\_SOFTWARE\\_VERSION](#) (Software Version) attribute.

This attribute is available only from the Network Interface, not CAN Objects.

**NC\_ATTR\_READ\_PENDING (Read Entries Pending)**

Returns the number of frames available in the read queue. Polling the available frames with this attribute can be used as an alternative to the [ncWaitForState](#) and [ncCreateNotification](#) functions.

**NC\_ATTR\_RTSI\_FRAME (RTSI Frame)**

Returns the `RTSI Frame` attribute as configured with [ncConfig](#).

**NC\_ATTR\_RX\_ERROR\_COUNTER (Receive Error Counter)**

Returns the Receive Error Counter from the Philips SJA1000 CAN controller. This Receive Error Counter is specified in the Bosch CAN standard as well as ISO CAN standards.

This attribute is unsupported for Series 1 CAN interfaces (returns error).

This attribute is available only from the Network Interface, not CAN Objects.

**NC\_ATTR\_SELF\_RECEPTION (Self Reception)**

Returns the `NC_ATTR_SELF_RECEPTION` attribute as configured with [ncConfig](#).

#### NC\_ATTR\_SERIES2\_COMP (Series 2 Comparator)

Returns the NC\_ATTR\_SERIES2\_COMP attribute as configured with [ncConfig](#).

This attribute is available only from the Network Interface, not CAN Objects.

This attribute is not supported for Series 1 CAN, 847x LIN, or 847x with Sync LIN interfaces (returns error).

#### NC\_ATTR\_SERIES2\_ERR\_ARB\_CAPTURE (Series 2 Error/Arb Capture)

Returns the current values of the Error Code Capture register and Arbitration Lost Capture register from the Philips SJA1000 CAN controller chip.

The Error Code Capture register provides information on bus errors that occur according to the CAN standard. A bus error increments either the Transmit Error Counter or the Receive Error Counter. When communication starts on the interface, the first bus error is captured into the Error Code Capture register, and retained until you get this attribute. After you get this attribute, the Error Code Capture register is again enabled to capture information for the next bus error.

The Arbitration Lost Capture register provides information on a loss of arbitration during transmits. Loss of arbitration is not considered an error. When communication starts on the interface, the first arbitration loss is captured into the Arbitration Lost Capture register, and retained until you get this attribute. After you get this attribute, the Arbitration Lost Capture register is again enabled to capture information for the next arbitration loss.

For each of the capture registers, a single-bit New flag indicates whether a new error has occurred since the last Get. If the New flag of a register is set, the associated fields contain new information. If the New flag of a register is clear, the associated fields are the same as the previous Get.

This attribute is commonly used with the NC\_ATTR\_SINGLE\_SHOT\_TX (Single Shot Transmit) attribute. When a Write function is used to transmit the single frame, you can get this attribute to determine if the transmit was successful. If the single shot transmit was not successful, this attribute provides detailed information regarding the failure.

This attribute is not supported for Series 1 CAN, 847x LIN, or 847x with Sync LIN interfaces (returns error). Since the information and bit format is very specific to the Philips SJA1000 CAN controller on Series 2 hardware, National Instruments cannot guarantee

compatibility for this attribute on future hardware series. When using this attribute in the application, it is best to get the NC\_ATTR\_HW\_SERIES (Series) attribute to verify that the CAN hardware is Series 2, 847x, or 847x with Sync.

Figure 11-8 and Table 11-6, Table 11-7, Table 11-8, Table 11-9, and Table 11-10 describe the format of bit fields in this attribute. The lowest byte (bits 0-7) corresponds to the Error Code Capture register. The next byte (bits 8-15) corresponds to the Arbitration Lost Capture register. Bit 16 (00010000 hex) is the New flag for the Error Code Capture fields. Bit 17 (00020000 hex) is the New flag for the Arbitration Lost Capture field. Bits marked as X are reserved, and should be ignored by the application.

The C/C++ header file `nican.h` provides the following macros to accept the attribute value as input and return a value as listed in the tables:

- NC\_GET\_ERRARB\_SEG (value)
- NC\_GET\_ERRARB\_DIR (value)
- NC\_GET\_ERRARB\_ERRC (value)
- NC\_GET\_ERRARB\_ALC (value)
- NC\_GET\_ERRARB\_NEWECC (value)
- NC\_GET\_ERRARB\_NEWALC (value)

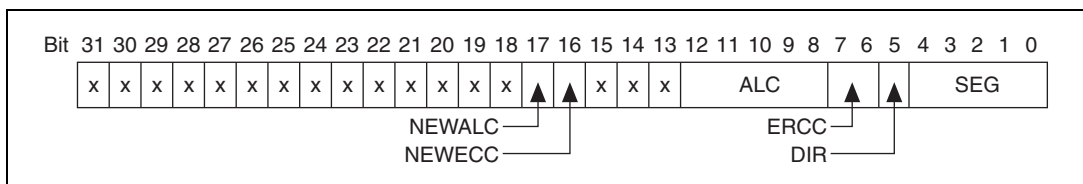

**Figure 11-8.** Series 2 Error/Arb Capture Format

**Table 11-6.** SEG Field of the Error Code Capture Register

Value in SEG Field	Meaning
0	No error (ignore DIR and ERRC as well)
2	ID.28 to ID.21 (most significant bits of identifier)
3	Start of frame
4	Bit SRTR (RTR for standard frames)
5	Bit IDE

**Table 11-6.** SEG Field of the Error Code Capture Register (Continued)

<b>Value in SEG Field</b>	<b>Meaning</b>
6	ID.20 to ID.18
7	ID.17 to ID.13
8	CRC sequence
9	Reserved bit 0
10	Data field
11	Data length code
12	Bit RTR (RTR for extended frames)
13	Reserved bit 1
14	ID.4 to ID.0
15	ID.12 to ID.5
17	Active error flag
18	Intermission
19	Tolerate dominant bits
22	Passive error flag
23	Error delimiter
24	CRC delimiter
25	Acknowledge slot
26	End of frame
27	Acknowledge delimiter
28	Overload flag

**Table 11-7.** DIR Field of the Error Code Capture Register

<b>Value in DIR Field</b>	<b>Meaning</b>
0	TX; error occurred during transmission
1	RX; error occurred during reception

**Table 11-8.** ERRC Field of the Error Code Capture Register

<b>Value in ERRC Field</b>	<b>Meaning</b>
0	Bit error
1	Form error
2	Stuff error
3	Other type of error

**Table 11-9.** ALC Field Contains the Arbitration Lost Capture Register

<b>Value in ALC Field</b>	<b>Meaning</b>
0	ID.28 (most significant bit of identifier; first ID bit in frame)
1	ID.27
2	ID.26
3	ID.25
4	ID.24
5	ID.23
6	ID.22
7	ID.21
8	ID.20
9	ID.19
10	ID.18
11	SRTR (RTR for standard frames)
12	IDE
13	ID.17 (extended frames only)
14	ID.16 (extended frames only)
15	ID.15 (extended frames only)
16	ID.14 (extended frames only)

**Table 11-9.** ALC Field Contains the Arbitration Lost Capture Register (Continued)

<b>Value in ALC Field</b>	<b>Meaning</b>
17	ID.13 (extended frames only)
18	ID.12 (extended frames only)
19	ID.11 (extended frames only)
20	ID.10 (extended frames only)
21	ID.9 (extended frames only)
22	ID.8 (extended frames only)
23	ID.7 (extended frames only)
24	ID.6 (extended frames only)
25	ID.5 (extended frames only)
26	ID.4 (extended frames only)
27	ID.3 (extended frames only)
28	ID.2 (extended frames only)
29	ID.1 (extended frames only)
30	ID.0 (extended frames only)
31	SRTR (RTR for extended frames)

**Table 11-10.** NEWEC Field is the New Flag for the Error Code Capture Register

<b>Value in NEWEC Field</b>	<b>Meaning</b>
0	SEG, DIR, and ERRC fields contain the same value as the last Get of this attribute. If no error has occurred since the start of communication, all fields are zero.
1	SEG, DIR, and ERRC fields contain information for a new bus error.

**Table 11-11.** NEWALC Field is the New Flag for the Arbitration Lost Capture Register

Value in NEWALC Field	Meaning
0	ALC field contains the same value as the last Get of this attribute.
1	ALC field contains information for a new arbitration loss.

**NC\_ATTR\_SERIES2\_FILTER\_MODE (Series 2 Filter Mode)**

Returns the NC\_ATTR\_SERIES2\_FILTER\_MODE attribute as configured with [ncConfig](#).

This attribute is available only from the Network Interface, not CAN Objects.

This attribute is not supported for Series 1 CAN, 847x LIN, or 847x with Sync LIN interfaces (returns error).

**NC\_ATTR\_SERIES2\_MASK (Series 2 Mask)**

Returns the NC\_ATTR\_SERIES2\_MASK attribute as configured with [ncConfig](#).

This attribute is available only from the Network Interface, not CAN Objects.

This attribute is not supported for Series 1 CAN, 847x LIN, or 847x with Sync LIN interfaces (returns error).

**NC\_ATTR\_SINGLE\_SHOT\_TX (Single Shot Transmit)**

Returns the NC\_ATTR\_SINGLE\_SHOT\_TX attribute as configured with [ncConfig](#).

This attribute is not supported for Series 1 CAN, 847x LIN, or 847x with Sync LIN interfaces (returns error).

**NC\_ATTR\_SOFTWARE\_VERSION (Software Version)**

Version of the NI-CAN software, with major, minor, update, and beta build numbers encoded in the U32 from high to low bytes. For example, 2.0.1 would be 02000100 hex, and 2.1 beta5 would be 02010005 hex.

This attribute is provided for backward compatibility.

[ncGetHardwareInfo](#) provides more complete version information.



**NC\_ATTR\_STATE (Object State)**

Returns the current state bit mask of the object. Polling with `ncGetAttribute` provides an alternative method of state detection than `ncWaitForState` or `ncCreateNotification`. For more information on the states returned from this attribute, refer to the `DesiredState` input of `ncWaitForState`.

**NC\_ATTR\_TERMINATION (Termination)**

Returns the value of the **Termination** attribute as configured with `ncSetAttribute`.

**NC\_ATTR\_TIMELINE\_RECOVERY (Timeline Recovery)**

Returns the Timeline Recovery attribute for the CAN Network Interface Object.

**NC\_ATTR\_TIMESTAMP\_FORMAT (Timestamp Format)**

Returns the present **Timestamp Format** programmed into the CAN or LIN hardware. This property applies to the entire card.

**NC\_ATTR\_TRANSCEIVER\_EXTERNAL\_IN (Transceiver External Inputs)**

Returns the transceiver external inputs for the Network Interface.

This attribute is available only for the Network Interface, not CAN Objects. Nevertheless, the attribute applies to communication by CAN Objects as well as the associated Network Interface.

Series 2 XS cards enable connection of an external transceiver. For an external transceiver, this attribute allows you to determine the input voltage on the STATUS pin of the CAN port.

For many models of CAN transceiver, an NERR pin is provided for detection of faults and other status. For such transceivers, you can wire the NERR pin to the STATUS pin of the CAN port.

This attribute is supported for Series 2 XS cards only (returns error for non-XS).

This attribute uses a bit mask. When using the attribute, use bitwise AND operations to check for values, not equality checks (equal, greater than, and so on).

**NC\_TRANSCEIVER\_IN\_STATUS (00000001 hex, STATUS pin)**

This bit is set when 5 V exists on the STATUS pin.

This bit is clear when 0 V exists on the STATUS pin.

`NC_ATTR_TRANSCEIVER_EXTERNAL_OUT` (Transceiver External Outputs)

Returns the transceiver external outputs for the Network Interface.

This attribute is available only for the Network Interface, not CAN Objects. Nevertheless, the attribute applies to communication by CAN Objects as well as the associated Network Interface.

Series 2 XS cards enable connection of an external transceiver. For an external transceiver, this attribute allows you to determine the output voltage on the MODE0 and MODE1 pins of the CAN port, and it allows you to determine if the CAN controller chip is sleeping.

For more information on the format of the value returned in this attribute, refer to the description of

`NC_ATTR_TRANSCEIVER_EXTERNAL_OUT` (Transceiver External Outputs) in `ncSetAttribute`.

This attribute is supported for Series 2 XS cards only (returns error for non-XS).

`NC_ATTR_TRANSCEIVER_MODE` (Transceiver Mode)

Returns the transceiver mode for the Network Interface.

This attribute is available only for the Network Interface, not CAN Objects. Nevertheless, the attribute applies to communication by CAN Objects as well as the associated Network Interface.

This attribute is not supported for Series 1 CAN, 847x LIN, or 847x with Sync LIN interfaces (returns error).

For Series 2 cards for the PCMCIA form factor, this property requires a corresponding Series 2 cable (dongle). For information on how to identify the series of the PCMCIA cable, refer to the [Series 2 Vs. Series 1](#) section of Chapter 1, [Introduction](#).

The transceiver mode changes when you set the mode within the application, or when a remote wakeup transitions the interface from Sleep to Normal mode. For more information, refer to `ncSetAttribute`.

This property uses the following values:

`NC_TRANSCEIVER_MODE_NORMAL` (Normal)

Transceiver is awake in normal communication mode.

`NC_TRANSCEIVER_MODE_SLEEP` (Sleep)

Transceiver and the CAN controller chip are both in sleep mode.

`NC_TRANSCEIVER_MODE_SW_WAKEUP` (Single Wire Wakeup)

Single Wire transceiver is in Wakeup Transmission mode.

NC\_TRANSCEIVER\_MODE\_SW\_HIGHSPEED (Single Wire High-Speed)

Single Wire transceiver is in High-Speed Transmission mode.

NC\_ATTR\_TRANSCEIVER\_TYPE (Transceiver Type)

Returns the type of transceiver for the Network Interface. For hardware other than Series 2 XS cards, the transceiver type is fixed. For Series 2 XS cards, the transceiver type reflects the most recent value specified by MAX or [ncSetAttribute](#).

This attribute is available only for the Network Interface, not CAN Objects. Nevertheless, the attribute applies to communication by CAN Objects as well as the associated Network Interface.

This attribute is not supported on the PCMCIA form factor.

This attribute uses the following values:

NC\_TRANSCEIVER\_TYPE\_DISC (Disconnect)

Transceiver type is Disconnect. This transceiver type is available on Series 2 XS cards only. For more information, refer to [ncSetAttribute](#).

NC\_TRANSCEIVER\_TYPE\_EXT (External)

Transceiver type is External. This transceiver type is available on Series 2 XS cards only. For more information, refer to [ncSetAttribute](#).

NC\_TRANSCEIVER\_TYPE\_HS (High-Speed)

Transceiver type is High-Speed (HS).

NC\_TRANSCEIVER\_TYPE\_LIN (LIN)

Transceiver type is LIN.

NC\_TRANSCEIVER\_TYPE\_LS (Low-Speed/Fault-Tolerant)

Transceiver type is Low-Speed/Fault-Tolerant (LS).

NC\_TRANSCEIVER\_TYPE\_SW (Single Wire)

Transceiver type is Single Wire (SW).

NC\_ATTR\_TRANSMIT\_MODE (Transmit Mode)

Returns the Transmit Mode for which the CAN Network Interface Object is presently configured.

The returned Transmit Mode is a Boolean value.

0	Immediate Transmit
1	Timestamped Transmit

#### NC\_ATTR\_TX\_ERROR\_COUNTER (Transmit Error Counter)

Returns the Transmit Error Counter from the Philips SJA1000 CAN controller. This Transmit Error Counter is specified in the Bosch CAN standard as well as ISO CAN standards.

This attribute is unsupported for Series 1 hardware (returns error).

This attribute is available only from the Network Interface, not CAN Objects.

#### NC\_ATTR\_VIRTUAL\_BUS\_TIMING (Virtual Bus Timing)

Returns a Boolean value of TRUE or FALSE to indicate whether Virtual Bus Timing has been set or not for the specified virtual interface. This attribute is applicable to all CAN Objects opened on the virtual interface.

#### NC\_ATTR\_WRITE\_ENTRIES\_FREE (Write Entries Free)

Returns the number of frames that can be accepted for a CAN or LIN Network Interface Object or CAN Object to write without causing overflow error.

#### NC\_ATTR\_WRITE\_PENDING (Write Entries Pending)

Returns the number of frames pending transmission in the write queue. If the intent is to verify that all pending frames have been transmitted successfully, waiting for the Write Success state is preferable to this attribute.

The Write Entries Pending attribute for 847x and 847x with Sync series CAN and LIN interfaces does not return the number of frames pending transmission in the write queue because the number does not take into account the frames in transit over the USB or waiting to be transmitted to the interface over the USB.

## Description

`ncGetAttribute` gets the value of the attribute specified by **AttrId** from the object specified by `ObjHandle`. Within NI-CAN Objects, you use attributes to access configuration settings, status, and other information about the object, but not data.

## ncGetHardwareInfo

---

### Purpose

Get CAN or LIN hardware information.

### Format

```
NCTYPE_STATUS _NCFUNC_ ncGetHardwareInfo(
                                NCTYPE_UINT32      CardNumber,
                                NCTYPE_UINT32      PortNumber,
                                NCTYPE_ATTRID      AttrId,
                                NCTYPE_UINT32      AttrSize,
                                NCTYPE_ANY_P      AttrPtr);
```

### Input

#### CardNumber

Specifies the CAN or LIN card number from 1 to Number of Cards, where Number of Cards is the number of CAN and LIN cards in the system. You can obtain Number of Cards using this function with CardNumber=1, PortNumber=1, and AttrID=Number of Cards.

#### PortNumber

Specifies the CAN or LIN port number from 1 to Number of Ports, where Number of Ports is the number of ports on the card. You can obtain Number of Ports using this function with PortNumber=1, and AttrID=Number of Ports.

#### AttrID

Specifies the attribute to get:

##### NC\_ATTR\_VERSION\_MAJOR (Version Major)

Returns the major version of the NI-CAN software. Use CardNumber 1 and PortNumber 1 as inputs.

The major version is the 'X' in X.Y.Z.

##### NC\_ATTR\_VERSION\_MINOR (Version Minor)

Returns the minor version of the NI-CAN software. Use CardNumber 1 and PortNumber 1 as inputs.

The minor version is the 'Y' in X.Y.Z.

#### NC\_ATTR\_VERSION\_UPDATE (Version Update)

Returns the update version of the NI-CAN software. Use `CardNumber 1` and `PortNumber 1` as inputs.

The update version is the 'Z' in X.Y.Z.

#### NC\_ATTR\_VERSION\_PHASE (Version Phase)

Returns the phase of the NI-CAN software. Use `CardNumber 1` and `PortNumber 1` as inputs.

Phase 1 specifies Alpha, phase 2 specifies Beta, and phase 3 specifies Final release. Unless you are participating in an NI-CAN beta program, you will always see 3.

#### NC\_ATTR\_VERSION\_BUILD (Version Build)

Returns the build of the NI-CAN software. Use `CardNumber 1` and `PortNumber 1` as inputs.

With each software development phase, subsequent NI-CAN builds are numbered sequentially. A given Final release version always uses the same build number, so unless you are participating in an NI-CAN beta program, this build number is not relevant.

#### NC\_ATTR\_VERSION\_COMMENT (Version Comment)

Returns any special comment on the NI-CAN software. `AttrPtr` must point to a buffer for the string, and `AttrSize` specifies the number of characters in that buffer. Use `CardNumber 1` and `PortNumber 1` as inputs.

This string is normally empty for a Final release. In rare circumstances, an NI-CAN prototype or patch may be released to a specific customer. For these special releases, the version comment describes the special features of the release.

#### NC\_ATTR\_NUM\_CARDS (Number of Cards)

Returns the number of CAN and LIN cards in the system. Use `CardNumber 1` and `PortNumber 1` as inputs.

If you are displaying all hardware information, you get this attribute first, then iterate through all cards with a For loop. Inside the For loop, get all card-wide attributes including `Number Of Ports`, then use another For loop to get port-wide attributes.

#### NC\_ATTR\_HW\_SERIAL\_NUM (Serial Number)

Card-wide attribute that returns the serial number of the card. Use the desired `CardNumber`, and `PortNumber 1` as inputs.

**NC\_ATTR\_HW\_FORMFACTOR (Form Factor)**

Card-wide attribute that returns the form factor of the card. Use the desired `CardNumber`, and `PortNumber 1` as inputs.

The returned Form Factor is an enumeration.

<code>NC_HW_FORMFACTOR_PCI</code>	<code>PCI</code>
<code>NC_HW_FORMFACTOR_PXI</code>	<code>PXI</code>
<code>NC_HW_FORMFACTOR_PCMCIA</code>	<code>PCMCIA</code>
<code>NC_HW_FORMFACTOR_AT</code>	<code>AT</code>
<code>NC_HW_FORMFACTOR_USB</code>	<code>USB</code>

**NC\_ATTR\_HW\_SERIES (Series)**

Card-wide attribute that returns the series of the card. Use the desired `CardNumber`, and `PortNumber 1` as inputs.

Series 1 hardware products use the Intel 82527 CAN controller.

Series 2 hardware products use the Philips SJA1000 CAN controller, plus improved RTSI synchronization features.

The returned Series is an enumeration.

<code>NC_HW_SERIES_1</code>	<code>Series 1</code>
<code>NC_HW_SERIES_2</code>	<code>Series 2</code>
<code>NC_HW_SERIES_847x</code>	<code>847x</code>
<code>NC_HW_SERIES_847x_SYNC</code>	<code>847x with Sync</code>
<code>NC_HW_SERIES_NIXNET</code>	<code>NI-XNET hardware</code>

**NC\_ATTR\_NUM\_PORTS (Number of Ports)**

Card-wide attribute that returns the number of ports on the card. Use the desired `CardNumber`, and `PortNumber 1` as inputs.

If you are displaying all hardware information, you get this attribute within the For loop for all cards, then iterate through all CAN ports to get port-wide attributes.

**NC\_ATTR\_TRANSCEIVER\_TYPE (Transceiver Type)**

This port-wide attribute returns the type of transceiver. Use the desired `CardNumber` and `PortNumber` as inputs.

For hardware other than Series 2 XS cards, the transceiver type is fixed. For Series 2 XS cards, the transceiver type reflects the most recent value specified by MAX or `ncSetAttribute`.

This attribute is not supported on the PCMCIA form factor.

This attribute uses the following values:

`NC_TRANSCEIVER_TYPE_HS` (High-Speed)

Transceiver type is High-Speed (HS).

`NC_TRANSCEIVER_TYPE_LS` (Low-Speed/Fault-Tolerant)

Transceiver type is Low-Speed/Fault-Tolerant (LS).

`NC_TRANSCEIVER_TYPE_SW` (Single Wire)

Transceiver type is Single Wire (SW).

`NC_TRANSCEIVER_TYPE_EXT` (External)

Transceiver type is External. This transceiver type is available on Series 2 XS cards only. For more information, refer to `ncSetAttribute`.

`NC_TRANSCEIVER_TYPE_DISC` (Disconnect)

Transceiver type is Disconnect. This transceiver type is available on Series 2 XS cards only. For more information, refer to `ncSetAttribute`.

`NC_TRANSCEIVER_TYPE_LIN` (LIN)

Transceiver type is LIN.

`NC_ATTR_INTERFACE_NUM` (Interface Number)

Port-wide attribute that returns the interface number of the port. Use the desired `CardNumber` and `PortNumber` as inputs.

The interface number is assigned to a physical port using the Measurement & Automation Explorer (MAX). The interface number is used as a string in the Frame API (for example, "CAN0"). The interface number is used for the `Interface` input in the Channel API.

`AttrSize`

Size of the attribute in bytes. Unless stated otherwise, `AttrSize` must be 4.



## Output

`AttrPtr`

Pointer used to return attribute value. Unless stated otherwise, `AttrPtr` must point to `NCTYPE_UINT32`.

## Return Value

Status of the function call, returned as a signed 32-bit integer. Zero means the function executed successfully. Negative specifies an error, meaning the function did not perform expected behavior. Positive specifies a warning, meaning the function performed as expected, but a condition arose that might require attention. For more information, refer to [ncStatusToString](#).

## Description

This function provides information about available CAN and LIN cards, but does not require you to open/start sessions. First get `Number of Cards`, then loop for each card. For each card, you can get card-wide attributes (such as `Form Factor`), and you also can get the `Number of Ports`. For each port, you can get port-wide attributes such as the `Transceiver`.

## ncOpenObject

---

### Purpose

Open an object.

### Format

```
NCTYPE_STATUS  ncOpenObject (
                NCTYPE_STRING  ObjName,
                NCTYPE_OBJH_P   ObjHandlePtr);
```

### Input

ObjName  
ASCII name of the object to open.

### Output

ObjHandlePtr  
Pointer used to return the Object handle. Used with all subsequent NI-CAN function calls.

### Return Value

Status of the function call, returned as a signed 32-bit integer. Zero means the function executed successfully. Negative specifies an error, meaning the function did not perform expected behavior. Positive specifies a warning, meaning the function performed as expected, but a condition arose that might require attention. For more information, refer to [ncStatusToString](#).

### Description

`ncOpenObject` takes the name of an object to open and returns a handle to that object that you use with subsequent NI-CAN function calls.

The Frame API and Channel API cannot use the same CAN network interface simultaneously. If the CAN network interface is already initialized in the Channel API, this function returns an error.

If `ncOpenObject` is successful, a handle to the newly opened object is returned. You use this object handle for all subsequent function calls for the object.

The following sections describe how to use `ncOpenObject` with the CAN or LIN Network Interface and CAN Object.

## CAN Network Interface

`ObjName` is the name of the CAN Network Interface Object to configure. This string uses the syntax `CANx`, where  $x$  is a decimal number starting at zero that indicates the CAN network interface (CAN0, CAN1, up to CAN63). CAN network interface names are associated with physical CAN ports using the Measurement & Automation Explorer (MAX).

The special interface values 256 and 257 refer to virtual interfaces. For more information on usage of virtual interfaces, refer to the [Frame to Channel Conversion](#) section of Chapter 6, [Using the Channel API](#).

## LIN Network Interface Object

This name uses the syntax `LINx`, where  $x$  is a decimal number starting at zero that indicates the LIN network interface (LIN0, LIN1, up to LIN63), where CAN and LIN share the same range. LIN network interface names are associated with physical LIN ports using the Measurement and Automation Explorer (MAX).

## CAN Object

`ObjName` is the name of the CAN Object to configure. This string uses the syntax `CANx::STDy` or `CANx::XTDy`. `CANx` is the name of the CAN network interface that you used for the preceding `ncConfig` function. STD indicates that the CAN Object uses a standard (11-bit) arbitration ID. XTD indicates that the CAN Object uses an extended (29-bit) arbitration ID. The number  $y$  specifies the actual arbitration ID of the CAN Object. The number  $y$  is decimal by default, but you also can use hexadecimal by adding `0x` to the beginning of the number. For example, `CAN0::STD25` indicates standard ID 25 decimal on CAN0, and `CAN1::XTD0x0000F652` indicates extended ID F652 hexadecimal on CAN1.

The special virtual interface names `CAN256` and `CAN257` are not supported for CAN Objects.

## ncRead

---

### Purpose

Read single frame from a CAN or LIN Object.

### Format

```
NCTYPE_STATUS ncRead(
                    NCTYPE_OBJH   ObjHandle,
                    NCTYPE_UINT32  DataSize,
                    NCTYPE_ANY_P   DataPtr);
```

### Input

`ObjHandle`  
Object handle.

`DataSize`  
Size of the data in bytes.

### Output

`DataPtr`  
Pointer used to return the frame.

### Return Value

Status of the function call, returned as a signed 32-bit integer. Zero means the function executed successfully. Negative specifies an error, meaning the function did not perform expected behavior. Positive specifies a warning, meaning the function performed as expected, but a condition arose that might require attention. For more information, refer to [ncStatusToString](#).

### Description

`ncRead` reads a single frame from the object specified by `ObjHandle`.

`DataPtr` points to the variable that holds the data. Its type is undefined so that you can use the appropriate host data type. `DataSize` indicates the size of variable pointed to by `DataPtr`, and is used to verify that the size you have available is compatible with the configured read size for the object.

For information on the data type to use with `DataPtr`, refer to the following Network Interface and CAN Object descriptions.

You use `ncRead` to obtain data from the read queue of an object. Because NI-CAN handles the read queue in the background, this function does not wait for new data to arrive. To ensure that new data is available before calling `ncRead`, first wait for the `NC_ST_READ_AVAIL` state. The `NC_ST_READ_AVAIL` state transitions from false to true when NI-CAN places a new data item into an empty read queue, and remains true until you read the last data item from the queue.

The `ncRead` function is useful when you need to process one frame at a time. In order to read multiple frames, such as for bus analyzer applications, use the `ncReadMult` function.

When you call `ncRead` for an empty read queue (`NC_ST_READ_AVAIL` false), the data from the previous call to `ncRead` is returned to you again, along with the `CanWarnOldData` warning. If no data item has yet arrived for the read queue, a default data item is returned, which consists of all zeros.

When a new data item arrives for a full queue, NI-CAN discards the item, and the next call to `ncRead` returns the `CanErrOverflowRead` error. You can avoid this overflow behavior by setting the read queue length to zero. When a new data item arrives for a zero length queue, it simply overwrites the previous item without indicating an overflow. The `NC_ST_READ_AVAIL` state and `CanWarnOldData` warning still behave as usual, but you can ignore them if you only want the most recent data. You can use the `NC_ATTR_READ_Q_LEN` attribute to configure the read queue length.

## Network Interface Object

The data type that you use with `ncRead` of the Network Interface is `NCTYPE_CAN_STRUCT`. When calling `ncRead`, you should pass size of (`NCTYPE_CAN_STRUCT`) for the `DataSize` parameter.

Within the `NCTYPE_CAN_STRUCT` structure, the `FrameType` field determines the meaning of all other fields. The following tables in this manual describe the fields of `NCTYPE_CAN_STRUCT` for each value of `FrameType`:

- Table 11-12, *[NCTYPE\\_CAN\\_STRUCT Fields for FrameType NC\\_FRMTYPE\\_DATA \(0\)](#)*
- Table 11-13, *[NCTYPE\\_FRAME\\_STRUCT Fields for FrameType NC\\_FRMTYPE\\_REMOTE \(1\)](#)*
- Table 11-14, *[NCTYPE\\_CAN\\_STRUCT Fields for FrameType NC\\_FRMTYPE\\_COMM\\_ERR \(2\)](#)*
- Table 11-15, *[NCTYPE\\_CAN\\_STRUCT Fields for FrameType NC\\_FRMTYPE\\_RTSI \(3\)](#)*
- Table 11-16, *[NCTYPE\\_CAN\\_STRUCT Fields for FrameType NC\\_FRMTYPE\\_TRIG\\_START \(4\)](#)*

- Table 11-17, *NCTYPE\_CAN\_STRUCT Fields for FrameType NC\_FRMTYPE\_CAN\_BUS\_ERROR\_FRAME (6)*
- Table 11-18, *NCTYPE\_CAN\_STRUCT Fields for FrameType NC\_FRMTYPE\_TRANSCEIVER\_FAULT\_FRAME (7)*
- Table 11-19, *NCTYPE\_CAN\_STRUCT Fields for FrameType NC\_FRMTYPE\_LIN\_FULL\_FRAME (18)*
- Table 11-20, *NCTYPE\_CAN\_STRUCT Fields for FrameType NC\_FRMTYPE\_LIN\_WAKEUP\_RECEIVED\_FRAME (19)*
- Table 11-21, *NCTYPE\_CAN\_STRUCT Fields for FrameType NC\_FRMTYPE\_LIN\_BUS\_INACTIVE\_FRAME (20)*
- Table 11-22, *NCTYPE\_CAN\_STRUCT Fields for FrameType NC\_FRMTYPE\_LIN\_BUS\_ERROR\_FRAME (21)*

To determine if your hardware supports one of the following frame types for this function, refer to Appendix D, *Frame Types for CAN and LIN Hardware*.

**Table 11-12.** NCTYPE\_CAN\_STRUCT Fields for FrameType NC\_FRMTYPE\_DATA (0)

Field Name	Data Type	Description
FrameType	NCTYPE_UINT8	NC_FRMTYPE_DATA (0) This value indicates a CAN data frame.
ArbitrationId	NCTYPE_CAN_ARBITID	Returns the arbitration ID of the received data frame.  The NCTYPE_CAN_ARBITID type is an unsigned 32-bit integer that uses the bit mask NC_FL_CAN_ARBITID_XTD (0x20000000) to indicate an extended ID. A standard ID (11-bit) is specified by default. The Network Interface receives data frames based on the comparators and masks configured in <a href="#">ncConfig</a> (including the Series 2 Filter Mode attributes).
Data	Array of 8 NCTYPE_UINT8	Returns the data bytes of the frame.
DataLength	NCTYPE_UINT8	Returns the number of data bytes received in the frame. This specifies the number of valid data bytes in Data.

**Table 11-12.** NCTYPE\_CAN\_STRUCT Fields for FrameType NC\_FRMTYPE\_DATA (0) (Continued)

Field Name	Data Type	Description
Timestamp	NCTYPE_ABS_TIME	<p>Returns the absolute timestamp when the data frame was received from the CAN network.</p> <p>The timestamp data type NCTYPE_ABS_TIME is a 64-bit unsigned integer compatible with the Win32 FILETIME type. This absolute time is kept in a Coordinated Universal Time (UTC) format. UTC time is loosely defined as the current date and time of day in Greenwich, England. Microsoft defines its UTC time (FILETIME) as a 64-bit counter of 100 ns intervals that have elapsed since 12:00 a.m., January 1, 1601. Since Timestamp is compatible with Win32 FILETIME, you can pass it into the Win32 <code>FileTimeToLocalFileTime</code> function to convert it to the local time zone, then pass the resulting local time to the Win32 <code>FileTimeToSystemTime</code> function to convert to the Win32 SYSTEMTIME type. SYSTEMTIME is a struct with fields for year, month, day, and so on. For more information on Win32 time types and functions, refer to the Microsoft Win32 documentation.</p>

**Table 11-13.** NCTYPE\_FRAME\_STRUCT Fields for FrameType NC\_FRMTYPE\_REMOTE (1)

Field Name	Data Type	Description
FrameType	NCTYPE_UINT8	NC_FRMTYPE_REMOTE (1)  This value indicates a CAN remote frame. Only Series 2 hardware, 847x CAN, or 847x with Sync CAN can receive remote frames using the Network Interface. For Series 1 hardware, you must handle incoming remote frames with CAN Objects only.
ArbitrationId	NCTYPE_CAN_ARBITID	Returns the arbitration ID of the received remote frame.  The NCTYPE_CAN_ARBITID type is an unsigned 32-bit integer that uses the bit mask NC_FL_CAN_ARBITID_XTD (0x20000000) to indicate an extended ID. A standard ID (11-bit) is specified by default. The Network Interface receives remote frames based on the comparators and masks configured in <a href="#">ncConfig</a> (including the Series 2 Filter Mode attributes).
Data	Array of 8 NCTYPE_UINT8	Remote frames do not contain data, so this array is empty.
DataLength	NCTYPE_UINT8	Returns the Data Length Code in the remote frame.
Timestamp	NCTYPE_ABS_TIME	Returns the absolute timestamp when the remote frame was received from the CAN network.  For information on the timestamp data type, refer to Table 11-12.



**Table 11-14.** NCTYPE\_CAN\_STRUCT Fields for FrameType NC\_FRMTYPE\_COMM\_ERR (2)

Field Name	Data Type	Description
FrameType	NCTYPE_UINT8	NC_FRMTYPE_COMM_ERR (2)  This value indicates a logged communication warning or error as reported by the CAN hardware. This frame type occurs only when you set the <code>Log Comm Warnings</code> attribute to TRUE and the CAN controller is in the error passive state. Refer to <a href="#">ncConfig</a> for details. For more information on CAN error handling, refer to the <a href="#">CAN Error Detection and Confinement</a> section of Appendix B, <i>Summary of the CAN Standard</i> .
ArbitrationId	NCTYPE_CAN_ARBITID	Indicates the type of communication problem:  8000000B hex:Comm. error: General 4000000B hex:Comm. warning: General 8001000B hex:Comm. error: Stuff 4001000B hex:Comm. warning: Stuff 8002000B hex:Comm. error: Format 4002000B hex:Comm. warning: Format 8003000B hex:Comm. error: No Ack 4003000B hex:Comm. warning: No Ack 8004000B hex:Comm. error: Tx 1 Rx 0 4004000B hex:Comm. warning: Tx 1 Rx 0 8005000B hex:Comm. error: Tx 0 Rx 1 4005000B hex:Comm. warning: Tx 0 Rx 1 8006000B hex:Comm. error: Bad CRC 4006000B hex:Comm. warning: Bad CRC 0000000B hex:Comm. errors/warnings cleared 8000000C hex:Transceiver fault warning 0000000C hex:Transceiver fault cleared
Data	Array of 8 NCTYPE_UINT8	This field is not applicable to this frame type, and should be ignored.

**Table 11-14.** NCTYPE\_CAN\_STRUCT Fields for FrameType NC\_FRMTYPE\_COMM\_ERR (2) (Continued)

Field Name	Data Type	Description
DataLength	NCTYPE_UINT8	This field is not applicable to this frame type, and should be ignored.
Timestamp	NCTYPE_ABS_TIME	Returns the absolute timestamp when the communications problem occurred.  For information on the timestamp data type, refer to Table 11-12.

**Table 11-15.** NCTYPE\_CAN\_STRUCT Fields for FrameType NC\_FRMTYPE\_RTISI (3)

Field Name	Data Type	Description
FrameType	NCTYPE_UINT8	NC_FRMTYPE_RTISI (3)  Indicates when a RTSI input pulse occurred relative to incoming CAN frames. This frame type occurs only when you set the RTSI Mode attribute to NC_RTISI_TIME_ON_IN (refer to <a href="#">ncConfig</a> for details).
ArbitrationId	NCTYPE_CAN_ARBITID	Returns the special value 40000001 hex.
Data	Array of 8 NCTYPE_UINT8	This field is not applicable to this frame type, and should be ignored.
DataLength	NCTYPE_UINT8	Returns the RTSI signal number detected.
Timestamp	NCTYPE_ABS_TIME	Returns the absolute timestamp when the RTSI input occurred.  For information on the timestamp data type, refer to Table 11-12.

**Table 11-16.** NCTYPE\_CAN\_STRUCT Fields for FrameType NC\_FRMTYPE\_TRIG\_START (4)

Field Name	Data Type	Description
IsRemote	NCTYPE_UINT8	Value 4 specifies a start trigger frame.  When the <b>Log Start Trigger</b> attribute is set to 1 (True), this frame indicates the time when the start trigger occurs. For example, if you use <a href="#">ncConnectTerminals</a> to connect a RTSI input to the start trigger, this frame occurs when the RTSI input pulse for the first time. Another use case for logging the start trigger would be for logging the received CAN frames in a file. This ensures that the first frame in the logfile is a start trigger frame, which specifies the absolute time (date/time) at which CAN communication started.
ArbitrationId	NCTYPE_CAN_ARBID	Value 0 is required.
Data	Array of 8 NCTYPE_UINT8	The single data byte in the array specifies the <b>Timestamp Format</b> (defined in <a href="#">ncSetAttribute</a> ) used for all subsequent CAN frames. The value is 0 for absolute timestamps, and 1 for relative timestamps.
DataLength	NCTYPE_UINT8	Value 1 is required.
Timestamp	NCTYPE_ABS_TIME	Absolute timestamp of the start trigger. Within a logfile, this timestamp indicates the date and time at which CAN communication started.  The format of this timestamp is always absolute, even when Data byte 0 specifies relative timestamp format. This absolute timestamp provides data/time information even when the CAN frames use the relative format.

**Table 11-17.** NCTYPE\_CAN\_STRUCT Fields for FrameType NC\_FRMTYPE\_CAN\_BUS\_ERROR\_FRAME (6)

Field Name	Data Type	Description
IsRemote	NCTYPE_UINT8	Value <b>6</b> represents a CAN bus error frame. Refer to the <a href="#">NC_ATTR_LOG_BUS_ERRORS (Log Bus Errors?)</a> attribute description for more information on CAN Bus Error frames.
ArbitrationId	NCTYPE_CAN_ARBID	Zero.
DataLength	NCTYPE_UINT8	Four.
Data	Array of 8 NCTYPE_UINT8	<p>0—Comm State (See description below)</p> <p>1—Transmit Error Counter</p> <p>2—Receive Error Counter</p> <p>3—ECC Register</p> <p>4—X</p> <p>5—X</p> <p>6—X</p> <p>7—X</p> <p><b>Note:</b> X means <i>Reserved</i> or <i>Don't Care</i>.</p> <p>The first data byte (Comm State) indicates the current communication state of the CAN controller. The states are:</p> <p>0—Error Active</p> <p>1—Error Passive</p> <p>2—Bus Off</p>
Timestamp	NCTYPE_ABS_TIME	Time when the bus error was detected.

**Table 11-18.** NCTYPE\_CAN\_STRUCT Fields for FrameType NC\_FRMTYPE\_TRANSCEIVER\_FAULT\_FRAME (7)

Field Name	Data Type	Description
IsRemote	NCTYPE_UINT8	Value <b>7</b> represents a transceiver fault frame. Refer to the <a href="#">NC_ATTR_LOG_TRANSCEIVER_FAULTS (Log Transceiver Faults?)</a> attribute description for more information on Transceiver Fault frames.
ArbitrationId	NCTYPE_CAN_ARBITID	Zero.
DataLength	NCTYPE_UINT8	One.
Data	Array of 8 NCTYPE_UINT8	0—Transceiver fault (0=fault cleared, 1=fault present) 1—X 2—X 3—X 4—X 5—X 6—X 7—X
Timestamp	NCTYPE_ABS_TIME	Time when the transceiver fault was detected.

**Table 11-19.** NCTYPE\_CAN\_STRUCT Fields for FrameType NC\_FRMTYPE\_LIN\_FULL\_FRAME (18)

Field Name	Data Type	Description
IsRemote	NCTYPE_UINT8	Value <b>18</b> represents a full frame for LIN communication. A full frame is reported when the LIN interface slave task has received one complete LIN frame. All frames for which the LIN interface slave task is a subscriber will be reported. Frames for which the LIN interface slave task is a publisher will be reported only if the <a href="#">NC_ATTR_SELF_RECEPTION (Self Reception)</a> attribute is set to TRUE.
ArbitrationId	NCTYPE_CAN_ARBITID	Zero to sixty-three.
DataLength	NCTYPE_UINT8	One to eight.

**Table 11-19.** NCTYPE\_CAN\_STRUCT Fields for FrameType NC\_FRMTYPE\_LIN\_FULL\_FRAME (18) (Continued)

Field Name	Data Type	Description
Data	Array of 8 NCTYPE_UINT8	LIN frame data.
Timestamp	NCTYPE_ABS_TIME	Time at point of reception of LIN frame checksum.

**Table 11-20.** NCTYPE\_CAN\_STRUCT Fields for FrameType NC\_FRMTYPE\_LIN\_WAKEUP\_RECEIVED\_FRAME (19)

Field Name	Data Type	Description
IsRemote	NCTYPE_UINT8	Value <b>19</b> represents a wakeup received frame for LIN communication. A wakeup received frame is reported when the LIN interface is asleep, the <a href="#">NC_ATTR_LIN_LOG_WAKEUP (LIN Log Wakeup)</a> attribute is set to TRUE, and a wakeup event is detected.
ArbitrationId	NCTYPE_CAN_ARBID	Zero.
DataLength	NCTYPE_UINT8	Zero.
Data	Array of 8 NCTYPE_UINT8	Ignored.
Timestamp	NCTYPE_ABS_TIME	Time at point of wakeup event detection.

**Table 11-21.** NCTYPE\_CAN\_STRUCT Fields for FrameType NC\_FRMTYPE\_LIN\_BUS\_INACTIVE\_FRAME (20)

Field Name	Data Type	Description
IsRemote	NCTYPE_UINT8	Value <b>20</b> represents a bus inactive frame for LIN communication. Bus inactive detection begins when the LIN interface senses the first activity on the bus. When activity ceases, a bus inactive frame is reported if the inactivity lasts for more than four seconds.
ArbitrationId	NCTYPE_CAN_ARBID	Zero.
DataLength	NCTYPE_UINT8	Zero.
Data	Array of 8 NCTYPE_UINT8	Ignored.
Timestamp	NCTYPE_ABS_TIME	Time at point of four second timeout.

**Table 11-22.** NCTYPE\_CAN\_STRUCT Fields for FrameType NC\_FRMTYPE\_LIN\_BUS\_ERROR\_FRAME (21)

Field Name	Data Type	Description
IsRemote	NCTYPE_UINT8	Value <b>21</b> represents a LIN bus error frame for LIN communication. A LIN bus error frame is reported when the <code>NC_ATTR_LOG_BUS_ERRORS (Log Bus Errors?)</code> attribute is set to TRUE, and a bus error occurs.
ArbitrationId	NCTYPE_CAN_ARBITID	Zero.
DataLength	NCTYPE_UINT8	Varies depending on the error. Refer to Table 11-24, <i>LIN Bus Errors and Descriptions</i> , in <code>ncSetAttribute</code> for information.
Data	Array of 8 NCTYPE_UINT8	Error frame information.
Timestamp	NCTYPE_ABS_TIME	Time at point of bus error detection.

## Error Active, Error Passive, and Bus Off States

When the CAN communication controller transfers into the error passive state, NI-CAN returns the warning `CanCommWarning` from read functions.

When the transmit error counter of the CAN communication controller increments above 255, the network interface transfers into the bus off state as dictated by the CAN protocol. The network interface stops communication so that you can correct the defect in the network, such as a malfunctioning cable or device. When bus off occurs, NI-CAN returns the `CanErrComm` error code.

If no CAN devices are connected to the network interface port, and you attempt to transmit a frame, the `CanWarnComm` status occurs. This warning occurs because the missing acknowledgment bit increments the transmit error counter until the network interface reaches the error passive state, but bus off state is never reached.

For more information about transceiver fault handling, refer to the description of the `NC_ATTR_LOG_COMM_ERRS` attribute ID in the `ncConfig` function description.

## CAN Object

The data type that you use with `ncRead` of the CAN Object is `NCTYPE_CAN_DATA_TIMED`. When calling `ncRead`, you should pass size of `(NCTYPE_CAN_DATA_TIMED)` for the `DataSize` parameter. Table 11-23, *NCTYPE\_CAN\_DATA\_TIMED Field Names*, describes the fields of `NCTYPE_CAN_DATA_TIMED`.

**Table 11-23.** NCTYPE\_CAN\_DATA\_TIMED Field Names

Field Name	Data Type	Description
Data	Array of 8 NCTYPE_UINT	<p>Data array returns 8 data bytes. The actual number of valid data bytes depends on the CAN Object configuration specified in <code>ncConfig</code>.</p> <p>If the CAN Object Communication Type specifies Transmit, data frames are transmitted, not received, so Data is ignored. For this Communication Type, the <code>ncRead</code> function has no effect. If the CAN Object Communication Type specifies Receive, Data always contains Data Length valid bytes, where Data Length was configured using <code>ncConfig</code>.</p>
Timestamp	NCTYPE_ABS_TIME	<p>Returns the absolute timestamp value. The timestamp data type <code>NCTYPE_ABS_TIME</code> is a 64-bit unsigned integer compatible with the Win32 FILETIME type. This absolute time is kept in a Coordinated Universal Time (UTC) format. UTC time is loosely defined as the current date and time of day in Greenwich, England. Microsoft defines its UTC time (FILETIME) as a 64-bit counter of 100 ns intervals that have elapsed since 12:00 a.m., January 1, 1601.</p> <p>Since Timestamp is compatible with Win32 FILETIME, you can pass it into the Win32 <code>FileTimeToLocalFileTime</code> function to convert it to the local time zone, then pass the resulting local time to the Win32 <code>FileTimeToSystemTime</code> function to convert to the Win32 SYSTEMTIME type. SYSTEMTIME is a struct with fields for year, month, day, and so on. For more information on Win32 time types and functions, refer to the Microsoft Win32 documentation.</p>



## ncReadMult

---

### Purpose

Read multiple frames from a CAN or LIN Object.

### Format

```
NCTYPE_STATUS ncReadMult (
    NCTYPE_OBJH ObjHandle,
    NCTYPE_UINT32 DataSize,
    NCTYPE_ANY_P DataPtr,
    NCTYPE_UINT32_P ActualDataSize);
```

### Input

ObjHandle

Object handle.

DataSize

The size of the data buffer in bytes.

DataPtr

Points to data buffer in which the data returned.

### Output

ActualDataSize

The number of bytes actually returned.

### Return Value

Status of the function call, returned as a signed 32-bit integer. Zero means the function executed successfully. Negative specifies an error, meaning the function did not perform expected behavior. Positive specifies a warning, meaning the function performed as expected, but a condition arose that might require attention. For more information, refer to [ncStatusToString](#).

## Description

This function returns multiple frames from the read queue of the object specified by `ObjHandle`. When used with the Network Interface, `ncReadMult` is useful in analyzer applications where data frames need to be acquired at a High-Speed and stored for analysis in the future. For single frame and most recent data frame acquisition, you should use `ncRead`.

`DataPtr` points to an array of either `NCTYPE_CAN_STRUCT` or `NCTYPE_CAN_DATA_TIMED`. `DataSize` indicates the size of the array pointed to by `DataPtr` (in bytes). This size is specified in bytes in order to verify that the proper data type and alignment is used. When `ncReadMult` returns, the number of bytes copied into `DataPtr` is provided in `ActualDataSize`.

Because NI-CAN handles the read queue in the background, this function does not wait for new data to arrive. To ensure that new data is available before calling `ncReadMult`, first wait for the `NC_ST_READ_MULT` state. Refer to `NC_ST_READ_MULT` (00000008 hex) in the `ncCreateNotification` function description for more information on this state.

Unlike the `ncRead` function, the `ncReadMult` function does not return the `CanWarnOldData` warning to indicate zero frames. If there is no new data, the function returns with an `ActualDataSize` of zero.

The description for `CanErrOverflowRead` and the host data types is identical to that of `ncRead` with the exception of `CanWarnOldData`, described above.

Refer to the `ncRead` function description for more details on the structures used with `ncReadMult`.

## ncSetAttribute

---

### Purpose

Set the value of an object attribute.

### Format

```
NCTYPE_STATUS ncSetAttribute(
    NCTYPE_OBJH   ObjHandle,
    NCTYPE_ATTRID AttrId,
    NCTYPE_UINT32 AttrSize,
    NCTYPE_ANY_P  AttrPtr);
```

### Input

ObjHandle

Object handle.

AttrId

Identifier of the attribute to set.

AttrSize

Size of the attribute in bytes.

AttrPtr

New attribute value. You provide the attribute value using the pointer AttrPtr.

### Output

#### Return Value

Status of the function call, returned as a signed 32-bit integer. Zero means the function executed successfully. Negative specifies an error, meaning the function did not perform expected behavior. Positive specifies a warning, meaning the function performed as expected, but a condition arose that might require attention. For more information, refer to [ncStatusToString](#).

## Description

`ncSetAttribute` sets the value of the attribute specified by `AttrId` in the object specified by `ObjHandle`.

`AttrPtr` points to the variable that holds the attribute value. Its type is undefined so that you can use the appropriate host data type for `AttrId`. `AttrSize` indicates the size of variable pointed to by `AttrPtr`. `AttrSize` is typically 4, and `AttrPtr` references a 32-bit unsigned integer.

The `ncSetAttribute` function allows for additional configuration beyond the original attributes used with `ncConfig`. For a listing of other attributes for the Network Interface and CAN Object, refer to `ncConfig`. Unless stated otherwise, communication must be stopped prior to changing an attribute with `ncSetAttribute`. While the Network Interface and all CAN Objects are stopped, you can set any of the `AttrId` mentioned in `ncConfig` using `ncSetAttribute`.

## Network Interface Object

The following attributes are available only for the Network Interface, not CAN Objects. Nevertheless, the attributes apply to communication by CAN Objects as well as the associated Network Interface.

### NC\_ATTR\_BAUD\_RATE (Baud Rate)

For NI CAN hardware the common baud rates supported include 5000, 6150, 7813, 8000, 10000, 12500, 15625, 16000, 20000, 25000, 31250, 33333, 40000, 50000, 62500, 80000, 83333, 100000, 125000, 160000, 200000, 250000, 400000, 500000, 800000, and 1000000. If you are familiar with the Bit Timing registers used in CAN controllers, you can use a special hexadecimal baud rate of `0x8000zzyy`, where `yy` is the desired value for register 0 (BTR0), and `zz` is the desired value for register 1 (BTR1) of the CAN controller.

For NI LIN hardware you can specify any baud rate from 2400 to 20000 baud. If the baud rate you select varies more than .5% from the calculated baud rate, you will receive a warning message. The calculation for the baud rate is documented as follows:

$$\text{Calculated Baud Rate} = 1,500,000/x$$

where  $x = (1,500,000/\text{Input Baud Rate})$ , rounded to the nearest integer.

**NC\_ATTR\_LIN\_CHECKSUM\_TYPE (LIN Checksum Type)**

Specifies the method the LIN interface should use when calculating checksums for published data, or verifying received checksums for subscribed-to data. The values for this attribute are:

0	Classic (default)
1	Enhanced

Setting the `NC_ATTR_LIN_CHECKSUM_TYPE` to Classic indicates that the LIN-specified checksum calculation algorithm should be applied only to the data bytes. Setting the `NC_ATTR_LIN_CHECKSUM_TYPE` to Enhanced indicates that the checksum calculation algorithm should be applied to the ID and data bytes.

**NC\_ATTR\_LIN\_ENABLE\_DLC\_CHECK (LIN Enable DLC Check)**

Specifies the manner in which the LIN interface detects end-of-response when writing a header `ISRemote` type. This attribute does not affect the LIN interface processing of the full and response `ISRemote` types. The values for this attribute are:

0	FALSE (default)
1	TRUE

When the LIN interface transmits a header, it expects an external slave to publish data in response. When writing headers, the LIN interface detects end-of-response using either the LIN-specified response timeout for a response containing the maximum number (8) of data bytes (`NC_ATTR_LIN_ENABLE_DLC_CHECK=FALSE`), or reception of a response containing DLC number of data bytes (`NC_ATTR_LIN_ENABLE_DLC_CHECK=TRUE`). If

`NC_ATTR_LIN_ENABLE_DLC_CHECK=FALSE`, then the minimum time separation between the transmission of headers will be *header time + time to subscribe to eight data bytes* (DLC is ignored) and *checksum + LIN interface inter-frame delay*. If `NC_ATTR_LIN_ENABLE_DLC_CHECK=TRUE`, then the minimum time separation between the transmission of headers will be *header time + time to subscribe to DLC number of data bytes* and *checksum + LIN interface inter-frame delay*.

If you want to transmit header frames, each separated by a unique schedule table amount of delay with maximum timing accuracy, set `NC_ATTR_LIN_ENABLE_DLC_CHECK` to TRUE. Note that if `NC_ATTR_LIN_ENABLE_DLC_CHECK=TRUE`, the LIN interface will verify that a DLC in the range of one to eight is in the header

IsRemote type written by the host. If

NC\_ATTR\_LIN\_ENABLE\_DLC\_CHECK=FALSE, the LIN interface will ignore the DLC in the header IsRemote type written by the host.

#### NC\_ATTR\_LIN\_LOG\_WAKEUP (LIN Log Wakeup)

Specifies whether the LIN interface should report wakeup events as frames (TRUE) or not (FALSE). Wakeup events are always reported as states. The values for this attribute are:

0	FALSE (default)
1	TRUE

#### NC\_ATTR\_LIN\_RESPONSE\_TIMEOUT (LIN Response Timeout)

Specifies an amount of response timeout, in 50  $\mu$ s increments, to add to the LIN-specified response timeout the LIN interface uses to detect certain bus errors and end-of-response. The values for this attribute are:

0	(default)
1	1 to 65535 (50 $\mu$ s increments to add to LIN-specified response timeout)

#### NC\_ATTR\_LIN\_SLEEP (LIN Sleep)

Sets the sleep state of the LIN interface. The values for this attribute are:

0	FALSE (default)
1	TRUE

The LIN interface powers up in the awake state (NC\_ATTR\_LIN\_SLEEP=FALSE). When the NC\_ATTR\_LIN\_SLEEP attribute is set to FALSE, the user may set it to TRUE at any time: Upon reception of a sleep frame (four second period of bus inactivity has passed), upon reception of a full frame containing go-to-sleep command data, or when it is desired to simply put the interface to sleep. When the NC\_ATTR\_LIN\_SLEEP attribute is set to TRUE, either the user or the state machines within the LIN interface may set the attribute to FALSE, depending upon whether the interface is acting as master or slave, and whether or not it is issuing or receiving the wakeup request.

`NC_ATTR_LISTEN_ONLY` (Listen Only?)

Specifies whether to use the listen only feature of the Philips SJA1000 CAN controller.

Communication must be stopped to set this attribute. Use `StartOnOpenFalse` with `ncConfig`, set the attribute, then use `ncAction` to start communication.

0 FALSE (default)

When set to FALSE, listen only mode is disabled (default).

Received frames are ACKnowledged, and frames can be transmitted using `ncWrite`.

1 TRUE

When set to TRUE, listen only mode is enabled.

The Network Interface and CAN Objects can only receive frames. The interface does not transmit on the network: no ACKnowledgements are transmitted for received frames, and `ncWrite` will return an error. The Philips SJA1000 CAN controller enters error passive state when listen only is enabled.

The listen only mode is not available on the Intel 82527 CAN controller used by Series 1 CAN hardware (returns error).

This attribute is available only for the Network Interface, not CAN Objects.

`NC_ATTR_LOG_BUS_ERRORS` (Log Bus Errors?)

Specifies whether to log bus errors when the interface detects a bus error. For CAN interfaces, the bus error frame is logged when a bus error is detected. The `NC_ATTR_LOG_BUS_ERRORS` attribute is not supported by Series 1 CAN interfaces. This attribute has to be set prior to starting the Network Interface. The values for this attribute are:

0 FALSE (default)

When set to FALSE, bus errors will not be logged and cannot be read (default).

## 1 TRUE

When set to TRUE, the Network Interface reports bus errors as a special frame in the read queue. For CAN, if the `NC_ATTR_LOG_COMM_WARNINGS` attribute is set to 1 (TRUE), the `NC_ATTR_LOG_BUS_ERRORS` attribute must be set to 0 (FALSE).

The CAN bus error frame has the following format:

Timestamp	Time when the bus error was detected.
Arbitration ID	0
IsRemote	6
DataLength	4
Data	Bytes
	0—Comm State (see description below)
	1—Transmit Error Counter
	2—Receive Error Counter
	3—ECC Register
	4—X
	5—X
	6—X
	7—X

**Note:** X means *Reserved* or *Don't Care*.

The first data byte (Comm State) indicates the current communication state of the CAN controller. The states are:

- 0—Error Active
- 1—Error Passive
- 2—Bus Off

For LIN interfaces, the bus error frame is logged into the read queue when a timeout or bus errors such as `Bit Framing` or `Checksum` occurs. This attribute must be set prior to starting the Network Interface.



The LIN bus error frame has the following format:

Timestamp	Time when the bus error was detected.
Arbitration ID	0
IsRemote	21
DataLength	4-7 (depends on Error code)
Data	Bytes
	0—Error code (most significant byte)
	1—Error code (least significant byte)
	2—X
	3—X
	4—Received byte (for applicable error code)
	5—Expected byte (for applicable error code)
	6—LIN ID (for applicable error code)
	7—X

**Note:** X means *Reserved* or *Don't Care*.

Data bytes zero and one (Error code) indicate the type of LIN bus error. Refer to Table 11-24 for a list of LIN bus error codes and descriptions. Data bytes two and three are reserved for internal use. For errors in which a received byte did not match the expected value, data byte four indicates the received value and data byte 5 indicates the expected value. For a bus error occurring at a point in the LIN frame after which the break, sync, and ID fields have been processed, data byte six indicates the LIN ID.



**Note** In Table 11-24, X means *Reserved*.

**Table 11-24.** LIN Bus Errors and Descriptions

Error Name	Error Code (hex)	Description	Frame Contents							
			DLC	B(0)	B(1)	B(2)	B(3)	B(4)	B(5)	B(6)
LinBusErrorNoResponse	8400	The LIN interface slave task received a header but no response.	7	84	00	X	X	0	0	ID
LinBusErrorResponseTooShort	8401	The LIN interface slave task received a header and only one byte of a response.	7	84	01	X	X	0	0	ID

Table 11-24. LIN Bus Errors and Descriptions (Continued)

Error Name	Error Code (hex)	Description	Frame Contents								
			DLC	B(0)	B(1)	B(2)	B(3)	B(4)	B(5)	B(6)	
LinBusErrorRxChecksumBit	C008	The LIN interface slave task received a checksum byte with a bit error.	7	C0	08	X	X	Received Checksum Byte	Expected Checksum Byte	ID	
LinBusErrorRxChecksumFraming	A008	The LIN interface slave task received a checksum byte with a framing error.	7	A0	08	X	X	0	0	ID	
LinBusErrorRxData0Framing	A010	The LIN interface slave task received data byte 0 with a framing error.	7	A0	10	X	X	0	0	ID	
LinBusErrorRxData1Framing	A011	The LIN interface slave task received data byte 1 with a framing error.	7	A0	11	X	X	0	0	ID	
LinBusErrorRxData2Framing	A012	The LIN interface slave task received data byte 2 with a framing error.	7	A0	12	X	X	0	0	ID	
LinBusErrorRxData3Framing	A013	The LIN interface slave task received data byte 3 with a framing error.	7	A0	13	X	X	0	0	ID	
LinBusErrorRxData4Framing	A014	The LIN interface slave task received data byte 4 with a framing error.	7	A0	14	X	X	0	0	ID	
LinBusErrorRxData5Framing	A015	The LIN interface slave task received data byte 5 with a framing error.	7	A0	15	X	X	0	0	ID	
LinBusErrorRxData6Framing	A016	The LIN interface slave task received data byte 6 with a framing error.	7	A0	16	X	X	0	0	ID	
LinBusErrorRxData7Framing	A017	The LIN interface slave task received data byte 7 with a framing error.	7	A0	17	X	X	0	0	ID	
LinBusErrorRxIdFraming	A020	The LIN interface slave task received an ID byte with a framing error.	6	A0	20	X	X	Received ID Byte	Expected ID Byte	N/A	
LinBusErrorRxIdParity	C020	The LIN interface slave task received an ID byte with a parity error.	6	C0	20	X	X	Received ID Byte	Expected ID Byte	N/A	
LinBusErrorRxIdTimeout	9020	The LIN interface slave task did not receive an ID byte within the header timeout period.	4	90	20	X	X	N/A	N/A	N/A	
LinBusErrorRxSyncBit	C040	The LIN interface slave task received a sync byte with a bit error.	6	C0	40	X	X	Received Sync Byte	Expected Sync Byte	N/A	
LinBusErrorRxSyncFraming	A040	The LIN interface slave task received a sync byte with a framing error.	4	A0	40	X	X	N/A	N/A	N/A	
LinBusErrorRxSyncTimeout	9040	The LIN interface slave task did not receive a sync byte within the header timeout period.	4	90	40	X	X	N/A	N/A	N/A	
LinBusErrorTxData0Bit	4010	The LIN interface slave task transmitted data byte 0 and self-received it with a bit error.	7	40	10	X	X	Received Data Byte	Expected Data Byte	ID	
LinBusErrorTxData1Bit	4011	The LIN interface slave task transmitted data byte 1 and self-received it with a bit error.	7	40	11	X	X	Received Data Byte	Expected Data Byte	ID	

**Table 11-24.** LIN Bus Errors and Descriptions (Continued)

Error Name	Error Code (hex)	Description	Frame Contents							
			DLC	B(0)	B(1)	B(2)	B(3)	B(4)	B(5)	B(6)
LinBusErrorTxData2Bit	4012	The LIN interface slave task transmitted data byte 2 and self-received it with a bit error.	7	40	12	X	X	Received Data Byte	Expected Data Byte	ID
LinBusErrorTxData3Bit	4013	The LIN interface slave task transmitted data byte 3 and self-received it with a bit error.	7	40	13	X	X	Received Data Byte	Expected Data Byte	ID
LinBusErrorTxData4Bit	4014	The LIN interface slave task transmitted data byte 4 and self-received it with a bit error.	7	40	14	X	X	Received Data Byte	Expected Data Byte	ID
LinBusErrorTxData5Bit	4015	The LIN interface slave task transmitted data byte 5 and self-received it with a bit error.	7	40	15	X	X	Received Data Byte	Expected Data Byte	ID
LinBusErrorTxData6Bit	4016	The LIN interface slave task transmitted data byte 6 and self-received it with a bit error.	7	40	16	X	X	Received Data Byte	Expected Data Byte	ID
LinBusErrorTxData7Bit	4017	The LIN interface slave task transmitted data byte 7 and self-received it with a bit error.	7	40	17	X	X	Received Data Byte	Expected Data Byte	ID
LinBusErrorTxData0Framing	2010	The LIN interface slave task transmitted data byte 0 and self-received it with a framing error.	7	20	10	X	X	0	0	ID
LinBusErrorTxData1Framing	2011	The LIN interface slave task transmitted data byte 1 and self-received it with a framing error.	7	20	11	X	X	0	0	ID
LinBusErrorTxData2Framing	2012	The LIN interface slave task transmitted data byte 2 and self-received it with a framing error.	7	20	12	X	X	0	0	ID
LinBusErrorTxData3Framing	2013	The LIN interface slave task transmitted data byte 3 and self-received it with a framing error.	7	20	13	X	X	0	0	ID
LinBusErrorTxData4Framing	2014	The LIN interface slave task transmitted data byte 4 and self-received it with a framing error.	7	20	14	X	X	0	0	ID
LinBusErrorTxData5Framing	2015	The LIN interface slave task transmitted data byte 5 and self-received it with a framing error.	7	20	15	X	X	0	0	ID
LinBusErrorTxData6Framing	2016	The LIN interface slave task transmitted data byte 6 and self-received it with a framing error.	7	20	16	X	X	0	0	ID
LinBusErrorTxData7Framing	2017	The LIN interface slave task transmitted data byte 7 and self-received it with a framing error.	7	20	17	X	X	0	0	ID
LinBusErrorTxChecksumBit	4008	The LIN interface slave task transmitted a checksum and self-received it with a bit error.	7	40	08	X	X	Received Checksum Byte	Expected Checksum Byte	ID
LinBusErrorTxChecksumFraming	2008	The LIN interface slave task transmitted a checksum and self-received it with a framing error.	7	20	08	X	X	0	0	ID

**Table 11-24.** LIN Bus Errors and Descriptions (Continued)

Error Name	Error Code (hex)	Description	Frame Contents							
			DLC	B(0)	B(1)	B(2)	B(3)	B(4)	B(5)	B(6)
LinBusErrorWhenMasterReceivesWakeup	8A00	The LIN interface as a master, failed to respond to reception of a wakeup on the LIN.	4	8A	00	X	X	N/A	N/A	N/A
LinBusErrorWhenMasterIssuesWakeup	0A00	The LIN interface failed to issue a wakeup on the LIN as a master.	4	0A	00	X	X	N/A	N/A	N/A
LinBusErrorWhenSlaveIssuesWakeup	900	The LIN interface failed to issue a wakeup on the LIN as a slave.	4	09	00	X	X	N/A	N/A	N/A

**NC\_ATTR\_LOG\_COMM\_WARNINGS (Log Comm Warnings)**

Specifies whether to log communication warnings (including transceiver faults) to the Network Interface read queue.

The values for this attribute are:

0 FALSE

When set to FALSE, the Network Interface reports CAN communication warnings (including transceiver faults). For more information, refer to [ncReadMult](#).

1 TRUE

When set to TRUE, the Network Interface reports CAN communication warnings (including transceiver faults) by storing a special frame in the read queue. The communication warnings are not reported the return value. For more information on communication warnings and errors, refer to [ncReadMult](#). The special communication warning frame uses the following format:

Timestamp	Time when error/warning occurred
Arbitration ID	Error/warning ID (refer to <a href="#">ncReadMult</a> )
IsRemote	2
DataLength	0
Data	N/A (ignore)

When calling `ncRead` or `ncReadMult` to read frames from the Network Interface, you typically use the `IsRemote` field to differentiate communications warnings from CAN frames. Refer to `ncReadMult` for more information.

This attribute applies only to Series 1 and Series 2 hardware.

This attribute is available only from the Network Interface, not CAN Objects.

#### `NC_ATTR_LOG_START_TRIGGER` (Log Start Trigger)

Set this attribute to true if you wish to log the start trigger into the read queue of the CAN or LIN Network Interface Object.

The values for this attribute are:

`NC_FALSE`

Disables the logging of the start trigger (default) in the read queue of the Network Interface Object.

`NC_TRUE`

Enables the logging of the start trigger in the read queue of the Network Interface Object. The start trigger is logged when the hardware starts communication.

This attribute should be set prior to starting the Network Interface Object. This attribute is applicable only to the Network Interface Object and setting this attribute on CAN Objects will result in a NI-CAN error.



**Note** Setting this attribute to true in applications that only transmit CAN frames has no effect.

#### `NC_ATTR_LOG_TRANSCEIVER_FAULT` (Log Transceiver Faults?)

Specifies whether to enable the logging of transceiver faults as frames in the read queue of the Network Interface Object. The values for this attribute are:

0      `FALSE`

When set to `FALSE`, transceiver faults will not be logged as frames (default).

## 1 TRUE

When set to TRUE, the transceiver faults are logged as special frames in the read queue of the Network Interface Object. For CAN, if the `NC_ATTR_LOG_COMM_WARNINGS` attribute is set to 1 (TRUE), `NC_ATTR_LOG_TRANSCEIVER_FAULTS` must be set to 0 (FALSE).

This attribute is supported only on High Speed and Low Speed CAN transceivers.

This attribute can be set before or after starting the CAN Network Interface Object. The frame will be logged each time the transceiver's NERR signal changes state. In order to filter out noise on this signal, the logging can occur up to 10ms apart. The transceiver fault frame as the following format:

Timestamp	Time when the transceiver fault was detected
Arbitration ID	0
IsRemote	7
DataLength	1
Data	Bytes
	0—Transceiver fault (0=fault cleared, 1=fault present)
	1—X
	2—X
	3—X
	4—X
	5—X
	6—X
	7—X

**Note:** X means *Reserved* or *Don't Care*.

`NC_ATTR_MASTER_TIMEBASE_RATE` (**Master Timebase Rate**)

Sets the rate (in MHz) of the external clock that is exported to the CAN card.

The values for this attribute are:

`NC_TIMEBASE_RATE_20` (20)

When synchronizing 2 CAN cards or synchronizing a CAN card with an E-Series DAQ card, the 20 Mhz master timebase rate is to be used. By default, this attribute is set to 20 Mhz.

`NC_TIMEBASE_RATE_10` (10)

The master timebase rate should be set to 10 Mhz when synchronizing a CAN card with an M-Series DAQ card. The M-Series DAQ card can export a 20 Mhz clock but it does this by using one of its two counters.

If your CAN-DAQ application does not use the 2 DAQ counters then, you can leave the timebase rate set to 20 Mhz (default).

This attribute can be set either before or after calling [ncConnectTerminals](#) to connect the **RTSI\_CLK** to **Master Timebase**. However, this attribute must always be called prior to starting the task.

This attribute is applicable only to PCI and PXI Series 2 cards. For PCMCIA cards, setting this attribute will return an error. On PXI cards, if **PXI\_CLK10** is routed to the Master Timebase, then the rate is fixed at 10 MHz (it over rides any previous setting of this attribute). Setting this attribute for Series 1 cards will also result in a NI-CAN error.

For the 847x series CAN and LIN hardware, setting this attribute has no effect. The 847x series CAN and LIN hardware automatically synchronize to a Master Timebase Rate of 1 MHz, 10 MHz, or 20 MHz. Refer to Appendix E, [Specifications](#), for details on synchronization triggers.

`NC_ATTR_READMULT_SIZE_FOR_NOTIFICATION` (ReadMult Size for Notification)

Sets the number of frames used as a threshold for the Read Multiple state. For more information on the Read Multiple state, refer to [ncWaitForState](#).

The default value is one half of **Read Queue Length**.

This attribute applies only to Series 1 and Series 2 hardware.

`NC_ATTR_SELF_RECEPTION` (Self Reception?)

For CAN, this specifies whether to echo successfully transmitted CAN or LIN frames into the read queue of the CAN or LIN Network Interface and/or CAN Objects. Each reception occurs

just as if the frame were received from another CAN or LIN device.

For self reception to operate properly, another CAN or LIN device must receive and acknowledge each transmit. If a transmitted frame is not successfully acknowledged, it is not echoed into the read queue.

Communication must be stopped to set this attribute. Use **Start On Open** `False` with `ncConfig`, set the attribute, then use `ncAction` to start communication.

0	FALSE	Disables Self Reception mode (default). Transmitted frames do not appear in read queues.
1	TRUE	Enables Self Reception mode. Transmitted frames appear in read queues as if they were received from another CAN or LIN device.

The Self Reception mode is not available on the Intel 82527 CAN controller used by Series 1 CAN hardware. For Series 1 interfaces, this attribute must be left at its default (zero).

This attribute is available only for the Network Interface Objects, not CAN Objects.

For LIN, this specifies whether or not to load frames for which the LIN interface slave task is the publisher of the response into the read queue.

0	FALSE	Disables Self Reception mode (default). Frames for which the LIN interface slave task is the publisher of the response do not appear in read queues.
1	TRUE	Enables Self Reception mode. Frames for which the LIN interface slave task is the publisher of the response appear in read queues as if they were the result of an external slave task publishing the response.

`NC_ATTR_SERIES_2_COMPARATOR` (Series 2 Comparator)

Specifies the filter comparator for the Philips SJA1000 CAN controller. This attribute is not supported for Series 1 CAN, 847x LIN, or 847x with Sync LIN interfaces (returns error).



This attribute specifies a comparator value that is checked against the ID, RTR, and data bits. The `NC_ATTR_SERIES_2_MASK` (Series 2 Mask) determines the applicable bits for comparison.

The default value of this attribute is zero.

The mapping of bits in this attribute to the ID, RTR, and data bits of incoming frames is determined by the value of the `NC_ATTR_SERIES_2_FILTER_MODE` attribute. Refer to the `NC_ATTR_SERIES_2_FILTER_MODE` (Series 2 Filter Mode) attribute to understand the format of this attribute as well as the `NC_ATTR_SERIES_2_MASK`.

Communication must be stopped to set this attribute. Use **Start On Open** False with `ncConfig`, set the desired attributes, then use `ncAction` to start communication.

#### `NC_ATTR_SERIES_2_MASK` (Series 2 Mask)

Specifies the filter mask for the Philips SJA1000 CAN controller. This attribute is not supported for Series 1 CAN, 847x LIN, or 847x with Sync LIN interfaces (returns error).

This attribute specifies a bit mask that determines the ID, RTR, and data bits that are compared. If a bit is clear in the mask, the corresponding bit in the `NC_ATTR_SERIES_2_COMPARATOR` (Series 2 Comparator) is checked. If a bit in the mask is set, that bit is ignored for the purpose of filtering (don't care). This interpretation is the opposite of the legacy Standard/Extended Mask attributes.

The default value of this attribute is hex FFFFFFFF, which means that all frames are received.

The mapping of bits in this attribute to the ID, RTR, and data bits of incoming frames is determined by the value of the `NC_ATTR_SERIES_2_FILTER_MODE` (Series 2 Filter Mode) attribute. Refer to `NC_ATTR_SERIES_2_FILTER_MODE` to understand the format of this attribute as well as the `NC_ATTR_SERIES_2_COMPARATOR`.

Communication must be stopped to set this attribute. Use **Start On Open** False with `ncConfig`, set the desired attributes, then use `ncAction` to start communication.

#### `NC_ATTR_SERIES_2_FILTER_MODE` (Series 2 Filter Mode)

The Philips SJA1000 CAN controller provides sophisticated filtering of received frames. This attribute specifies the filtering mode, which is used in conjunction with the

`NC_ATTR_SERIES_2_MASK` and  
`NC_ATTR_SERIES_2_COMPARATOR` attributes.

This attribute is not supported for Series 1 CAN, 847x LIN, or 847x with Sync LIN interfaces (returns error). For Series 1, the Standard Mask/Comparator and Extended Mask/Comparator attributes are programmed directly into the Intel 82527 CAN controller. Use those attributes to specify filtering of received frames on Series 1 interfaces.

The Philips SJA1000 does not support distinct standard and extended masking. Therefore, on Series 2 interfaces the Standard Mask/Comparator and Extended Mask/Comparator attributes are implemented in software (for backward compatibility). Since software masking can have an adverse impact on receive performance, National Instruments recommends that you disable software masking for Series 2 interfaces. Disable software masking by specifying don't-care (0) for all four mask/comparator attributes of `ncConfig`.

Communication must be stopped to set this attribute. Use **Start On Open** False with `ncConfig`, set the desired attributes, then use `ncAction` to start communication.

Since the format of the filters is very specific to the Philips SJA1000 CAN controller, National Instruments cannot guarantee compatibility for this attribute on future hardware series. When using this attribute in the application, it is best to get the `NC_ATTR_HW_SERIES` (Series) attribute to verify that the CAN hardware is Series 2, 847x, or 847x with Sync.

The filtering specified by this attribute and the Series 2 Mask/Comparator applies to the CAN Network Interface Object and all CAN Objects for that interface. For example, if you specify filters that discard ID 5, then open a CAN Object to receive ID 5, the CAN Object will not receive data.

The default value for this attribute is  
`NC_FILTER_SINGLE_STANDARD`.

This attribute uses the following values:

`NC_FILTER_SINGLE_STANDARD` (Single Standard)

Filter all standard (11-bit) frames using a single mask/comparator filter.

Figure 11-9 describes the format of the Series 2 Mask and Series 2 Comparator attributes for this filter mode.

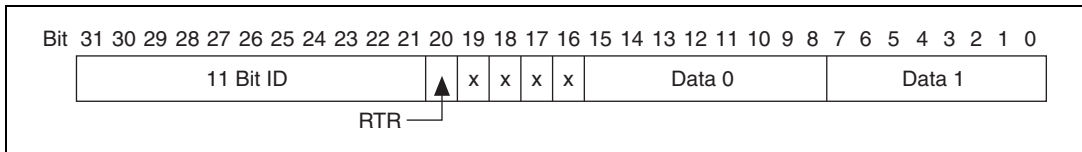

**Figure 11-9.** Mask/Comparator for Single-Standard Filter Mode

The 11 Bit ID compares all 11 bits of standard IDs. The RTR bit determines whether the filter compares remote (1) or data (0) frames. Bits marked as X are reserved, and should be cleared to zero by the application. Data 0 compares the first data byte in the frame, and Data 1 compares the second data byte.

**NC\_FILTER\_SINGLE\_EXTENDED (Single Extended)**

Filter all extended (29-bit) frames using a single mask/comparator filter.

Figure 11-10 describes the format of the Series 2 Mask and Series 2 Comparator attributes for this filter mode.

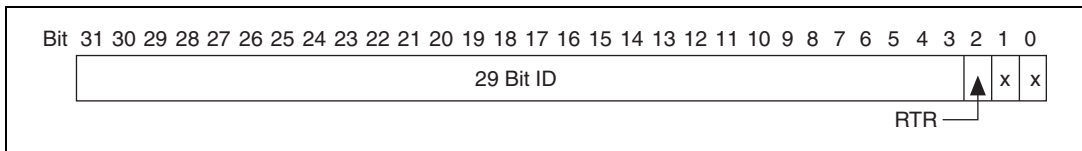

**Figure 11-10.** Mask/Comparator for Single-Extended Filter Mode

The 29 Bit ID compares all 29 bits of extended IDs. The RTR bit determines whether the filter compares remote (1) or data (0) frames. Bits marked as X are reserved, and should be cleared to zero by the application.

**NC\_FILTER\_DUAL\_STANDARD (Dual Standard)**

Filter all standard (11-bit) frames using a two separate mask/comparator filters. If either filter matches the frame, it is received. The frame is discarded only when neither filter detects a match.

Figure 11-11 describes the format of the Series 2 Mask and Series 2 Comparator attributes for this filter mode.

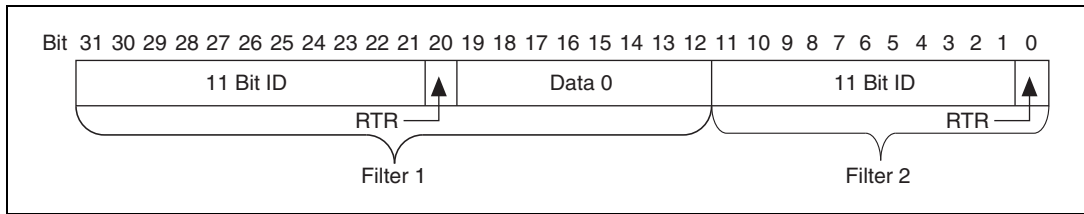

**Figure 11-11.** Mask/Comparator for Dual-Standard Filter Mode

Filter 1 includes the 11 Bit ID, the RTR bit, and the first data byte in the frame. Filter 2 includes the 11 bit ID, and the RTR bit (no data).

#### NC\_FILTER\_DUAL\_EXTENDED (Dual Extended)

Filter all extended (29-bit) frames using a two separate mask/comparator filters. If either filter matches the frame, it is received. The frame is discarded only when neither filter detects a match.

Figure 11-12 describes the format of the Series 2 Mask and Series 2 Comparator attributes for this filter mode.

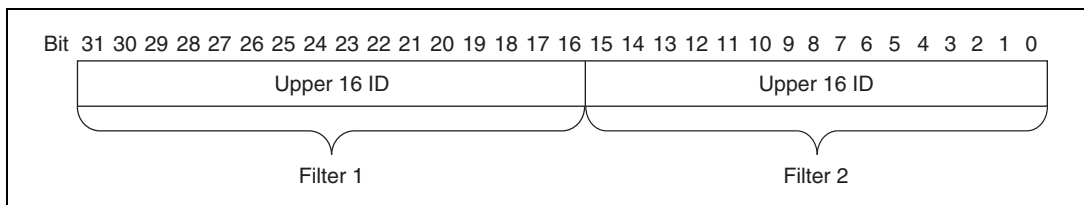

**Figure 11-12.** Mask/Comparator for Dual-Extended Filter Mode

Each Upper 16 ID filter compares the 16 most significant bits of the 29-bit extended ID.

#### NC\_ATTR\_SINGLE\_SHOT\_TRANSMIT (Single Shot Transmit?)

Specifies whether to retry failed CAN frame transmissions (Series 2, 847x CAN, and 847x with Sync CAN interfaces only).

Communication must be stopped to set this attribute. Use **Start On Open** False with `ncConfig`, set the attribute, then use `ncAction` to start communication.

0	FALSE	Enables retry as defined in the CAN specification (default). If a CAN frame is not transmitted successfully, the CAN controller will immediately retry.
1	TRUE	Enables single shot transmit. If a CAN frame is not transmitted successfully, the CAN controller will not retry.

For Series 1, 847x LIN, and 847x with Sync LIN interfaces, this attribute must be left at its default (zero).

This attribute is available only for the Network Interface, not CAN Objects.

#### NC\_ATTR\_TERMINATION (Termination)

Specifies the termination setting for your hardware. This attribute is not supported on Series 1, Series 2, USB-8473, or USB-8473s hardware. The values for this attribute are:

##### LS CAN

0	(1.11 k $\Omega$ )	When set to 0 on USB-8472 or USB-8472s hardware, the termination is set to 1.11 k $\Omega$ .
1	(4.99 k $\Omega$ )	When set to 1 on USB-8472 or USB-8472s hardware, the termination is set to 4.99 k $\Omega$ .

##### LIN

0	(Disabled)	When set to 0 on USB-8476 or USB-8476s hardware, the termination is disabled.
1	(Enabled)	When set to 1 for USB-8476 or USB-8476s hardware, the termination is enabled.

#### NC\_ATTR\_TIMELINE\_RECOVERY (Timeline Recovery)

Specifies whether to configure the CAN Network Interface Object to recover the original timeline when a timestamped transmit is late.

This attribute is applicable only when the Transmit Mode attribute (`NC_ATTR_TRANSMIT_MODE`) is set to Timestamped Transmit (1).

Due to factors such as CAN bus arbitration, the time that a frame transmits successfully may be later than the original time specified. When a timestamped transmit is late, this attribute determines how NI-CAN will adjust transmit times for subsequent frames.

The values for this attribute are:

`NC_FALSE`

Do not recover the original timeline. Frames always transmit with the original gap or greater. This behavior is useful when you need to maintain a minimum gap between frames.

Figure 11-13 shows an original timeline of three frames with a 10 ms gap. When frame B transmits 3 ms late, frame C continues to transmit 10 ms later, so the actual timeline slips.

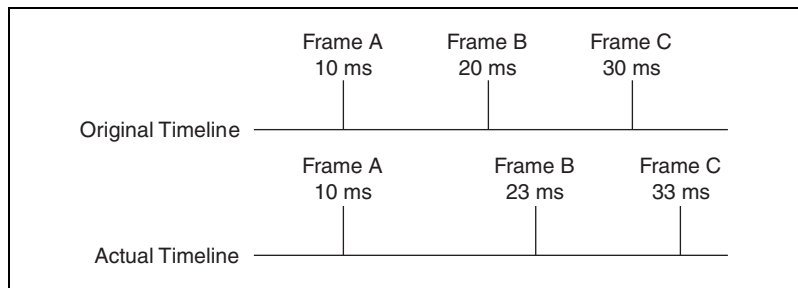

**Figure 11-13.** Example with Time Recovery Disabled

`NC_TRUE`

Recover the original timeline. When a timestamped transmit is late, the subsequent frame will transmit with a reduced gap. This behavior is useful when you need to maintain a timeline, such as when synchronizing CAN output with analog or digital output. Figure 11-14 shows an original timeline of three frames with a 10 ms gap. When frame B transmits 3 ms late, frame C transmit 7 ms later in order to recover the timeline.

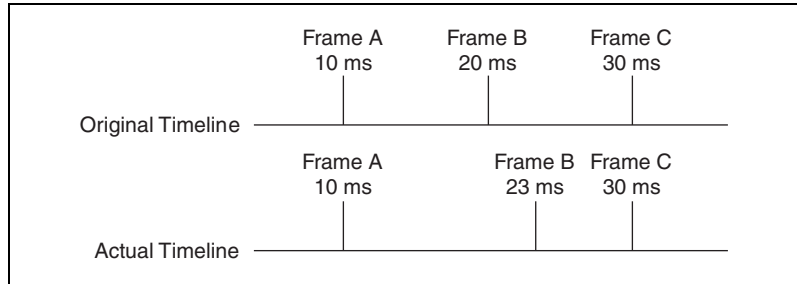

**Figure 11-14.** Example with Time Recovery Enabled

The default value for this attribute is zero (disable).

This attribute has to be set prior to starting the CAN Network Interface Object.

This attribute applies only to Series 1 and Series 2 hardware.

#### NC\_ATTR\_TIMESTAMP\_FORMAT (Timestamp Format)

Sets the format of the timestamps reported by the on-board timer on the CAN or LIN hardware.

The default value for this attribute is Absolute.

The values for this attribute are:

##### NC\_TIME\_FORMAT\_ABSOLUTE (0)

Sets the timestamp format to absolute. In the absolute format, the timestamp returned by NI-CAN read functions is the LabVIEW date/time format (DBL representing the number of seconds elapsed since 12:00 a.m., Friday, January 1, 1904).

##### NC\_TIME\_FORMAT\_RELATIVE (1)

Sets the timestamp format to relative. In the relative format, the timestamp returned by the NI-CAN read functions will be zero based (DBL representing the number of seconds since the starting the task).

A typical use case for this attribute would be if data received from two RTSI synchronized CAN or LIN cards is to be correlated. For that use case, this attribute must be set to 1 for all of the CAN or LIN cards being synchronized. Setting this attribute on one port of a 2-port card will also reset the timestamp of the second port, since resetting the timestamp on the port involves resets the on-board timer.

This attribute should be set prior to starting any communication on the CAN or LIN hardware.

**NC\_ATTR\_TRANSCEIVER\_EXTERNAL\_OUT (Transceiver External Outputs)**

Sets the transceiver external outputs for the Network Interface.

This attribute is available only for the Network Interface, not CAN Objects. Nevertheless, the attribute applies to communication by CAN Objects as well as the associated Network Interface.

Series 2 XS cards enable connection of an external transceiver. For an external transceiver, this attribute allows you to set the output voltage on the MODE0 and MODE1 pins of the CAN port, and it allows you control the sleep mode of the on-board CAN controller chip.

For many models of CAN transceiver, EN and NSTB pins control the transceiver mode, such as whether the transceiver is sleeping, or communicating normally. For such transceivers, you can wire the EN and NSTB pins to the MODE0 and MODE1 pins of the CAN port.

The default value of this attribute is 00000003 hex. For many models of transceiver, this specifies normal communication mode for the transceiver and CAN controller chip. If the transceiver requires a different MODE0/MODE1 combination for normal mode, you can use external inverters to change the default 5 V to 0 V.

This attribute is supported for Series 2 XS cards only. This attribute is not supported when the

NC\_ATTR\_TRANSCEIVER\_TYPE (Transceiver Type) is any value other than External. To control the mode of an internal transceiver, use the NC\_ATTR\_TRANSCEIVER\_MODE (Transceiver Mode) attribute.

This attribute uses a bit mask. Use bitwise OR operations to set multiple values.

NC\_TRANSCEIVER\_OUT\_MODE0 (00000001 hex, MODE0 pin)

Set this bit to drive 5 V on the MODE0 pin. This is the default value. This bit is set automatically when a remote wakeup is detected.

Clear this bit to drive 0 V on the MODE0 pin.

NC\_TRANSCEIVER\_OUT\_MODE1 (00000002 hex, MODE1 pin)

Set this bit to drive 5 V on the MODE1 pin. This is the default value. This bit is set automatically when a remote wakeup is detected.



Clear this bit to drive 0 V on the MODE1 pin.

`NC_TRANSCEIVER_OUT_SLEEP` (00000100 hex, Sleep CAN controller chip)

Set this bit to place the CAN controller chip into sleep mode. This bit controls the mode of the CAN controller chip (sleep or normal), and the independent MODE0/MODE1 bits control the mode of the external transceiver. When you set this bit to place the CAN controller into sleep mode, you typically specify MODE0/MODE1 bits that place the external transceiver into sleep mode as well.

When the CAN controller is asleep, a remote wakeup will automatically place the CAN controller into its normal mode of communication. In addition, the MODE0/MODE1 pins are restored to their default values of 5 V. Therefore, a remote wakeup causes this attribute to change from the value that you set for sleep mode, back to its default 00000003 hex. You can determine when this has occurred by getting

`NC_ATTR_TRANSCEIVER_EXTERNAL_OUT` (Transceiver External Outputs) using `ncGetAttribute`. For more information on remote wakeup, refer to the `NC_ATTR_TRANSCEIVER_MODE` (Transceiver Mode) attribute for internal transceivers.

Clear this bit to place the CAN controller chip into normal communication mode. If the CAN controller was previously in sleep mode, this performs a local wakeup to restore communication.

`NC_ATTR_TRANSCEIVER_MODE` (Transceiver Mode)

Sets the transceiver mode for the Network Interface. The transceiver mode controls whether the transceiver is asleep or communicating, as well as other special modes.

This attribute is available only for the Network Interface, not CAN Objects. Nevertheless, the attribute applies to communication by CAN Objects as well as the associated Network Interface.

This attribute is supported on Series 2, 847x CAN, and 847x with Sync CAN interfaces only.

For Series 2 cards for the PCMCIA form factor, this property requires a corresponding Series 2 cable (dongle). For information on how to identify the series of the PCMCIA cable, refer to [Series 2 Vs. Series 1](#) section of Chapter 1, [Introduction](#).

For Series 2 XS cards, this attribute is not supported when the `NC_ATTR_TRANSCEIVER_TYPE` (Transceiver Type) is External. To control the mode of an external transceiver, use the `NC_ATTR_TRANSCEIVER_EXTERNAL_OUT` (Transceiver External Outputs) attribute.

The default value for this attribute is Normal.

This attribute uses the following values:

`NC_TRANSCEIVER_MODE_NORMAL` (Normal)

Set transceiver to normal communication mode. If you set Sleep mode previously, this performs a local wakeup of the transceiver and CAN controller chip.

`NC_TRANSCEIVER_MODE_SLEEP` (Sleep)

Set transceiver and the CAN controller chip to sleep (or standby) mode.

If the transceiver supports multiple sleep/standby modes, the NI CAN hardware implementation ensures that all of those modes are equivalent with regard to the behavior of the transceiver on the network. For more information on the physical specifications of normal and sleep modes of each transceiver, refer to Chapter 3, *NI CAN and LIN Hardware*.

You can set Sleep mode only while the interface is communicating. If the Network Interface has not been started, setting the transceiver mode to Sleep will return an error.

When the interface enters sleep mode, communication is not possible until a wakeup occurs. All pending frame transmissions are deferred until the wakeup occurs. The transceiver and CAN controller wake from sleep mode when either a local wakeup or remote wakeup occurs.

A *local wakeup* occurs when the application sets the transceiver mode to Normal (or some other communication mode).

A *remote wakeup* occurs when a remote node transmits a CAN frame (referred to as the wakeup frame). The wakeup frame wakes up the transceiver and CAN controller chip of the NI CAN interface. The wakeup frame is not received or acknowledged by the CAN controller chip. When the wakeup frame ends, the NI CAN interface enters Normal mode, and again receives and transmits CAN frames. If the node that transmitted the wakeup frame did not detect an acknowledgement (such as if other nodes were also waking),

it will retry the transmission, and the retry will be received by the NI CAN interface.

For a remote wakeup to occur for Single Wire transceivers, the node that transmits the wakeup frame must first place the network into the Single Wire Wakeup Transmission mode by asserting a higher voltage (typically 12 V). For more information, refer to `NC_TRANSCEIVER_MODE_SW_WAKEUP` (Single Wire Wakeup) mode.

When the local or remote wakeup occurs, frame transmissions resume from the point at which the original Sleep was set.

You can detect when a remote wakeup occurs by using `ncGetAttribute` with the Transceiver Mode attribute. If you need to suspend the application while waiting for the remote wakeup, use the Remote Wakeup state of `ncWaitForState` or `ncCreateNotification`.

#### `NC_TRANSCEIVER_MODE_SW_HIGHSPEED` (Single Wire High-Speed)

Set Single Wire transceiver to High-Speed Transmission mode.

This mode is supported on Single Wire (SW) ports only.

The Single Wire High-Speed Transmission mode disables the internal waveshaping function of the transceiver, which allows baud rates up to 100 kbytes/s to be used. The disadvantage versus Normal (which allows up to 40 kbytes/s baud) is degraded EMC performance. Other than the disabled waveshaping, this mode is similar to Normal mode. CAN frames can be received and transmitted normally.

This mode has no relationship to High-Speed (HS) transceivers. It is merely a higher speed mode of the Single Wire (SW) transceiver, typically used for downloading large amounts of data to a node.

The Single Wire transceiver does not support use of this mode in conjunction with Sleep mode. For example, a remote wakeup cannot transition from Sleep to this Single Wire High-Speed mode.

#### `NC_TRANSCEIVER_MODE_SW_WAKEUP` (Single Wire Wakeup)

Set Single Wire transceiver to Wakeup Transmission mode.

This mode is supported on Single Wire (SW) ports only.

The Single Wire Wakeup Transmission mode drives a higher voltage level on the network to wakeup all sleeping nodes. Other than this higher voltage, this mode is similar to Normal mode. CAN frames can be received and transmitted normally.

Since you use the Single Wire Wakeup mode to wakeup other nodes on the network, it is not typically used in combination with Sleep mode for a given interface.

The timing of how long the wakeup voltage is driven is controlled entirely by the application. The application will typically change to Single Wire Wakeup mode, transmit a wakeup frame, then return to Normal mode.

The following sequence demonstrates a typical sequence of steps for sleep and wakeup between two Single Wire NI CAN interfaces. The sequence assumes that CAN0 is the sleeping node, and CAN1 originates the wakeup.

1. Start both CAN0 and CAN1. Both use the default Normal mode.
2. Set Transceiver Mode of CAN0 to Sleep.
3. Set Transceiver Mode of CAN1 to Single Wire Wakeup.
4. Write data to CAN1 to transmit a wakeup frame to CAN0.
5. Set Transceiver Mode of CAN1 to Normal.
6. Now both CAN0 and CAN1 are in Normal mode again.

#### NC\_ATTR\_TRANSCEIVER\_TYPE (Transceiver Type)

For XS software selectable physical layer cards that provide a software-switchable transceiver, the Transceiver Type attribute sets the type of transceiver. When the transceiver is switched from one type to another, NI-CAN ensures that the switch is undetectable from the perspective of other nodes on the network.

The value of this attribute can be changed using the [ncSetAttribute](#) function only. You cannot use this attribute in the [ncConfig](#) function.

The default value for this attribute is specified within MAX. If you change the transceiver type in MAX to correspond to the network in use, you can avoid setting this attribute within the application.

This attribute is available only for the Network Interface, not CAN Objects. Nevertheless, the attribute applies to communication by CAN Objects as well as the associated Network Interface.

Communication for all objects on the Network Interface must be stopped prior to setting this attribute. You typically do this by

calling `ncConfig` with Start On Open set to false, then `ncOpenObject`, then `ncSetAttribute` to set Transceiver Type, then `ncAction` to start communication. Prior to changing the Transceiver Type again, you must use `ncAction` to stop communication.

You can only set this attribute for Series 2 XS interfaces.

This attribute uses the following values:

`NC_TRANSCEIVER_TYPE_HS` (High-Speed)

Switch the transceiver to High-Speed (HS).

`NC_TRANSCEIVER_TYPE_LS` (Low-Speed/Fault-Tolerant)

Switch the transceiver to Low-Speed/Fault-Tolerant (LS).

`NC_TRANSCEIVER_TYPE_SW` (Single Wire)

Switch the transceiver to Single Wire (SW).

`NC_TRANSCEIVER_TYPE_EXT` (External)

Switch the transceiver to External. The External type allows you to connect a transceiver externally to the interface. For more information on connecting transceivers externally, refer to Chapter 3, *NI CAN and LIN Hardware*.

When this transceiver type is selected, you can use the Transceiver External Outputs and Transceiver External Inputs attributes to access the external mode and status pins of the connector.

`NC_TRANSCEIVER_TYPE_DISC` (Disconnect)

Disconnect the CAN controller chip from the connector. This value is used when you physically switch an external transceiver. You first set Transceiver Type to Disconnect, then switch from one external transceiver to another, then set Transceiver Type to External. For more information on connecting transceivers externally, refer to Chapter 3, *NI CAN and LIN Hardware*.

`NC_ATTR_TRANSMIT_MODE` (Transmit Mode)

Specifies whether to configure the CAN Network Interface Object to Immediate Transmit mode or Timestamped Transmit mode.

The default value for this attribute is zero (Immediate Transmit).

The values for this attribute are:

`NC_TX_IMMEDIATE (0)`

Configures the Network Interface Object in the Immediate Transmit mode. In the Immediate Transmit mode, the CAN frames are transmitted as and when frames are written into the Network Interface Object's write queue. CAN frames can be written into the Network Interface Objects write queue by either using `ncWrite` or `ncWriteMult`. Timestamps are ignored by NI-CAN when the Network Interface Object is configured in this mode.

`NC_TX_TIMESTAMPED (1)`

Configures the Network Interface Object in the Timestamped Transmit mode. In this mode, NI-CAN spaces the frame transmission according to the difference in timestamps between consecutive frames. For example, if every frame provided to `ncWrite` increments by 10 milliseconds, the frames will be transmitted with a 10 millisecond gap.

If the timestamp of the CAN frame to be transmitted is less than the timestamp of the previous CAN frame, **Timestamped Transmit** is reset and the CAN frame will be transmitted immediately on the bus without adding any delay. For example, if you write a frame with a relative timestamp 30 ms followed by a frame with a timestamp 15 ms, the two frames will be transmitted back to back.

Use `ncWriteMult` to write CAN frames with timestamps into the write queue of the Network Interface Object.

To use the `ncWrite` in Timestamped Transmit mode, refer to the description of `ncWrite`.

This attribute has to be set prior to starting the CAN Network Interface Object.

This attribute applies only to Series 1 and Series 2 hardware.

`NC_ATTR_VIRTUAL_BUS_TIMING (Virtual Bus Timing)`

Sets the Virtual Bus Timing of the virtual device.

`NC_TRUE`

Enables Virtual Bus Timing. By turning Virtual Bus Timing on, frame timestamps are recalculated as they transfer across the virtual bus. This mode is useful when you want the virtual bus to behave as much like a real bus as possible.

NC\_FALSE

Disables Virtual Bus Timing. By turning Virtual Bus Timing off, the CAN bus simulation is disabled and CAN frames are copied from the write queue of one virtual interface to the read queue of the second virtual interface. This setting is useful if you desire to only convert frames to channels or vice versa and not simulate actual CAN bus communication.

If this attribute is set on real hardware, an error will be returned.

The Virtual Bus Timing has to be set to the same value on both virtual interfaces.

This attribute must be set prior to starting the virtual interface. Refer to the [Frame to Channel Conversion](#) section of Chapter 6, [Using the Channel API](#) for more information.

## ncStatusToString

---

### Purpose

Convert status code into a descriptive string.

### Format

```
void          ncStatusToString(
              NCTYPE_STATUS      Status,
              NCTYPE_UINT32      SizeOfString,
              NCTYPE_STRING      String);
```

### Input

*Status*

Nonzero status code returned from NI-CAN function.

*SizeOfString*

Size of String buffer (in bytes).

### Output

*String*

ASCII string that describes *Status*.

### Description

When the status code returned from an NI-CAN function is nonzero, an error or warning is indicated. This function is used to obtain a description of the error/warning for debugging purposes.

If you want to avoid displaying error messages while debugging the application, you can use the `Explain.exe` utility. This console application is located in the `Utilities` subfolder of the NI-CAN installation folder, which is typically `\Program Files\National Instruments\NI-CAN\Utilities`. You enter an NI-CAN status code in the command line, `Explain 0XBFF62201` for example, and the utility displays the description.

The return code is passed into the `Status` parameter. The `SizeOfString` parameter indicates the number of bytes available in `String` for the description. The description will be truncated to size `SizeOfString` if needed, but a size of 2048 characters is large enough to



hold any description. The text returned in `String` is null-terminated, so it can be used with ANSI C functions such as `printf`.

For applications written in C or C++, each NI-CAN function returns a status code as a signed 32-bit integer. Table 11-24 summarizes the NI-CAN use of this status.

**Table 11-25.** NI-CAN Status Codes

Status Code	Meaning
Negative	Error—Function did not perform expected behavior.
Positive	Warning—Function performed as expected, but a condition arose that may require attention.
Zero	Success—Function completed successfully.

The application code should check the status returned from every NI-CAN function. If an error is detected, you should close all NI-CAN handles, then exit the application. If a warning is detected, you can display a message for debugging purposes, or simply ignore the warning.

The following piece of code shows an example of handling NI-CAN status during application debugging.

```
status= ncOpenObject ("CAN0", &MyObjHandle);
PrintStat (status, "ncOpenObject CAN0");
```

where the function `PrintStat` has been defined at the top of the program as:

```
void PrintStat(NCTYPE_STATUS status,char *source)
{
    char statusString[2048];
    if(status !=0)
    {
        ncStatusToString(status, size of (statusString), statusString);
        printf("\n%s\nSource = %s\n", statusString, source);
        if (status < 0)
        {
            ncCloseObject(MyObjHandle); exit(1);
        }
    }
}
```

In some situations, you may want to check for specific errors in the code. For example, when `ncWaitForState` times out, you may want to continue communication, rather than exit the application. To check for specific errors, use the constants defined in `nican.h`. These constants have the same names as described in this manual. For example, to check for a function timeout:

```
if (status ==CanErrFunctionTimeout)
```

The function `ncStatusToString` returns the string results as an array of `char (* char)`. VB is not able to convert this array to a string automatically. Therefore, VB users should call the wrapper function `ncStatToStr`.

## ncWaitForState

---

### Purpose

Wait for one or more states to occur in an object.

### Format

```
NCTYPE_STATUS ncWaitForState(
    NCTYPE_OBJH ObjHandle,
    NCTYPE_STATE DesiredState,
    NCTYPE_UINT32 Timeout,
    NCTYPE_STATE_P StatePtr);
```

### Input

`ObjHandle`  
Object handle.

`DesiredState`  
States for which to wait.

`Timeout`  
Length of time to wait in milliseconds.

### Output

`StatePtr`  
Current state of object when desired states occur. The state is returned to you using the pointer `StatePtr`.

### Return Value

Status of the function call, returned as a signed 32-bit integer. Zero means the function executed successfully. Negative specifies an error, meaning the function did not perform expected behavior. Positive specifies a warning, meaning the function performed as expected, but a condition arose that might require attention. For more information, refer to [ncStatusToString](#).

## Description

You use `ncWaitForState` to wait for one or more states to occur in the object specified by `ObjHandle`.

This function waits up to `Timeout` for one of the bits set in `DesiredState` to become set in the attribute `NC_ATTR_STATE`. You can use the special `Timeout` value `NC_DURATION_INFINITE` (FFFFFFFF hex) to wait indefinitely.

`DesiredState` specifies a bit mask of states for which the wait should return. You can use a single state alone, or you can OR them together.

`NC_ST_READ_AVAIL` (00000001 hex)

At least one frame is available, which you can obtain using an appropriate read function.

The state is set whenever a frame arrives for the object. The state is cleared when the read queue is empty.

`NC_ST_READ_MULT` (00000008 hex)

A specified number of frames are available, which you can obtain using `ncReadMult`. The number of frames is one half the `Read Queue Length` by default, but you can change it using the `ReadMult Size for Notification` attribute of `ncSetAttribute`.

The state is set whenever the specified number of frames are stored in the read queue of the object. The state is cleared when you call the read function, and less than the specified number of frames exist in the read queue.

This state applies only to Series 1 and Series 2 hardware.

`NC_ST_REMOTE_WAKEUP` (00000040 hex)

Remote wakeup occurred, and `Transceiver Mode` (`NC_ATTR_TRANSCEIVER_MODE`) has changed from Sleep to Normal. For more information on remote wakeup, refer to the `NC_ATTR_TRANSCEIVER_MODE` (Transceiver Mode) attribute.

This state is set when a remote wakeup occurs (end of wakeup frame). This state is not set when the application changes `Transceiver Mode` from Sleep to Normal (local wakeup).

This state is cleared when:

- You open the Network Interface, such as when the application begins.
- You stop the Network Interface.
- You set the `Transceiver Mode`, such as each time you set Sleep mode.

For as long as this state is true, the transceiver mode is Normal. The transceiver mode also can be Normal when this state is false, such as when you perform a local wakeup.

#### NC\_ST\_WRITE\_MULT (00000080 hex)

The state is set whenever there is free space in the write queue to accept at least 512 frames to write. The state is cleared when you call the `ncWrite` or `ncWriteMult` function, and less than 512 frames can be accepted to write in the write queue.

This state is valid only on the Network Interface.

#### NC\_ST\_WRITE\_SUCCESS (00000002 hex)

All frames provided through write function have been successfully transmitted onto the network. Successful transmit means that the frame won arbitration, and was acknowledged by a remote device.

The state is set when the last frame in the write queue is transmitted successfully. The state is cleared when a write function is called.

When communication starts, the `NC_ST_WRITE_SUCCESS` state is true by default.

For CAN, write success means that the frame won arbitration, and was acknowledged by a remote device. For LIN, write success means that the frame was successfully processed by the LIN interface.

When the states in `DesiredState` are detected, the function returns the current value of the `NC_ATTR_STATE` attribute. If an error occurs, the function returns immediately, and the state returned is zero.

While waiting for the desired states, `ncWaitForState` suspends the current thread execution. Other Win32 threads in the application can still execute.

If you want to allow other code in the application to execute while waiting for NI-CAN states, refer to the `ncCreateNotification` function.

The functions `ncWaitForState` and `ncCreateNotification` use the same underlying implementation. Therefore, for each object handle, only one of these functions can be pending at a time. For example, you cannot invoke `ncWaitForState` twice from different threads for the same object. For different object handles, these functions can overlap in execution.

## ncWrite

---

### Purpose

Write a single frame to a CAN or LIN Network Interface Object.

### Format

```
NCTYPE_STATUS ncWrite(
    NCTYPE_OBJH ObjHandle,
    NCTYPE_UINT32 DataSize,
    NCTYPE_ANY_P DataPtr);
```

### Input

`ObjHandle`

Object handle.

`DataSize`

Size of the data in bytes.

`DataPtr`

Data written to the object. You provide the data using the pointer `DataPtr`.

### Output

#### Return Value

Status of the function call, returned as a signed 32-bit integer. Zero means the function executed successfully. Negative specifies an error, meaning the function did not perform expected behavior. Positive specifies a warning, meaning the function performed as expected, but a condition arose that might require attention. For more information, refer to [ncStatusToString](#).

### Description

`ncWrite` writes a single frame to the object specified by `ObjHandle`.

`DataPtr` points to the variable from which the data is written. Its type is undefined so that you can use the appropriate host data type. `DataSize` indicates the size of variable pointed to by `DataPtr`, and is used to verify that the size you provide is compatible with the configured write size for the object.

You use `ncWrite` to place data into the write queue of an object. Because NI-CAN handles the write queue in the background, this function does not wait for data to be transmitted on the network. To make sure that the data is transmitted successfully after calling `ncWrite`, wait for the `NC_ST_WRITE_SUCCESS` state. The `NC_ST_WRITE_SUCCESS` state transitions from false to true when the write queue is empty, and NI-CAN has successfully transmitted the last data item onto the network. The `NC_ST_WRITE_SUCCESS` state remains true until you write another data item into the write queue.

When communication starts, the `NC_ST_WRITE_SUCCESS` state is true by default.

When you configure an object to transmit data onto the network periodically, it obtains data from the object write queue each period. If the write queue is empty, NI-CAN transmits the data of the previous period again. NI-CAN transmits this data repetitively until the next call to `ncWrite`.

If an object write queue is full, a call to `ncWrite` returns the `CanErrOverflowWrite` error and NI-CAN discards the data you provide. One way to avoid this overflow error is to set the write queue length to zero. When `ncWrite` is called for a zero length queue, the data item you provide with `ncWrite` simply overwrites the previous data item without indicating an overflow. A zero length write queue is often useful when an object is configured to transmit data onto the network periodically, and you simply want to transmit the most recent data value each period. It is also useful when you plan to always wait for `NC_ST_WRITE_SUCCESS` after every call to `ncWrite`. You can use the `NC_ATTR_WRITE_Q_LEN` attribute to configure the write queue length.

For information on the proper data type to use with `DataPtr`, refer to the CAN Network Interface Object and CAN Object descriptions below.

## Network Interface Object

The data type that you use with `ncWrite` of the Network Interface is `NCTYPE_CAN_FRAME`. When calling `ncWrite`, you should pass size of (`NCTYPE_CAN_FRAME`) for the `DataSize` parameter.

Within the `NCTYPE_CAN_FRAME` structure, the `IsRemote` (frame type) field determines the meaning of all other fields. Table 11-26, [NCTYPE\\_CAN\\_FRAME Fields for IsRemote NC\\_FRMTYPE\\_DATA \(0\)](#), Table 11-27, [NCTYPE\\_CAN\\_FRAME fields for IsRemote NC\\_FRMTYPE\\_REMOTE \(1\)](#), Table 11-28, [NCTYPE\\_CAN\\_FRAME fields for IsRemote NC\\_FRMTYPE\\_RESPONSE\\_ENTRY\\_FRAME \(16\)](#), Table 11-29, [NCTYPE\\_CAN\\_FRAME fields for IsRemote NC\\_FRMTYPE\\_LIN\\_HEADER\\_FRAME \(17\)](#), and Table 11-30, [NCTYPE\\_CAN\\_FRAME fields for IsRemote NC\\_FRMTYPE\\_LIN\\_FULL\\_FRAME \(18\)](#), describe the fields of `NCTYPE_CAN_FRAME` for each value of `IsRemote`.

To determine if your hardware supports one of the following frame types for this function, refer to Appendix D, [Frame Types for CAN and LIN Hardware](#).

**Table 11-26.** NCTYPE\_CAN\_FRAME Fields for IsRemote NC\_FRMTYPE\_DATA (0)

Field Name	Data Type	Description
IsRemote	NCTYPE_UINT8	NC_FRMTYPE_DATA (0) Transmit a CAN data frame.
ArbitrationId	NCTYPE_CAN_ARBITID	Specifies the arbitration ID of the frame to transmit.  The NCTYPE_CAN_ARBITID type is an unsigned 32-bit integer that uses the bit mask NC_FL_CAN_ARBITID_XTD (0x20000000) to indicate an extended ID. A standard ID (11-bit) is specified by default. In order to specify an extended ID (29-bit), OR in the bit mask NC_FL_CAN_ARBITID_XTD.
Data	Array of 8 NCTYPE_UINT8	Specifies the data bytes of the frame.
DataLength	NCTYPE_UINT8	Specifies the number of data bytes to transmit. This number of valid data bytes must be provided in Data.

**Table 11-27.** NCTYPE\_CAN\_FRAME fields for IsRemote NC\_FRMTYPE\_REMOTE (1)

Field Name	Data Type	Description
IsRemote	NCTYPE_UINT8	NC_FRMTYPE_REMOTE (1) Transmit a CAN remote frame. Both Series 1 and Series 2 hardware can transmit remote frames using the Network Interface.
ArbitrationId	NCTYPE_CAN_ARBITID	Specifies the arbitration ID of the frame to transmit.  The NCTYPE_CAN_ARBITID type is an unsigned 32-bit integer that uses the bit mask NC_FL_CAN_ARBITID_XTD (0x20000000) to indicate an extended ID. A standard ID (11-bit) is specified by default. In order to specify an extended ID (29-bit), OR in the bit mask NC_FL_CAN_ARBITID_XTD.
Data	Array of 8 NCTYPE_UINT8	Remote frames do not contain data, so this array is empty.
DataLength	NCTYPE_UINT8	Specifies the Data Length Code to transmit in the remote frame.



**Table 11-28.** NCTYPE\_CAN\_FRAME fields for IsRemote  
NC\_FRMTYPE\_RESPONSE\_ENTRY\_FRAME (16)

Field Name	Data Type	Description
IsRemote	NCTYPE_UINT8	<p>Value <b>16</b> represents a response entry frame for LIN communication. The behavior resulting from writing a response type to the LIN interface depends upon whether the <b>LIN Sleep</b> attribute is set to TRUE or FALSE (the LIN interface is asleep or awake, respectively).</p> <p>If the <b>LIN Sleep</b> attribute is set to FALSE:</p> <p>A response entry frame is issued when it is desired to configure the LIN interface slave task to subscribe to or publish data, in response to a particular header ID received from a master task. Each response entry frame indicates the ID of the header for which it is to respond, whether the response is to publish data or subscribe to data, and if it is to publish data, the data length code (DLC) and data values. The DLC determines whether the response will be to subscribe (DLC = 0), or publish (DLC = data length), in response to a header containing the ID of the response frame. Sixty-four response entry frames (one for each of the sixty-four LIN IDs) may be written to the response queue in the LIN interface. When the Network Interface is created or reset, the interface is reset to act as a slave and to respond as subscriber to data for all LIN IDs.</p> <p>If the <b>LIN Sleep</b> attribute is set to TRUE:</p> <p>A response entry frame is issued when the LIN interface has been acting as a slave (processing master headers), has been put asleep, and is desired to be used to wake the bus and initiate the transmission of headers by the master. When the response entry type is written to the LIN interface, two things occur. First, the response queue is loaded with the ID, DLC, and data (if DLC is non-zero meaning the response is to publish), of the response entry frame. Next the interface transmits a wakeup break on the bus. Per the LIN specification, it either waits until the master acknowledges the wakeup break by writing a header within the specified time, or re-transmits the wakeup break if it does not. When the master responds with a header, the LIN interface sets the <b>LIN Sleep</b> attribute to FALSE, and responds to the ID contained in the header in the manner (publish or subscribe) specified for that ID in the response queue.</p>
ArbitrationId	NCTYPE_CAN_ARBITID	Zero to sixty-three.

**Table 11-28.** NCTYPE\_CAN\_FRAME fields for IsRemote  
NC\_FRMTYPE\_RESPONSE\_ENTRY\_FRAME (16) (Continued)

Field Name	Data Type	Description
DataLength	Array of 8 NCTYPE_UINT8	Zero if the response is to subscribe to data. Actual length of <b>Data</b> if the response is to publish data.
Data	NCTYPE_UINT8	Ignored if <b>DataLength</b> is zero. Data to publish if <b>DataLength</b> is non-zero.

**Table 11-29.** NCTYPE\_CAN\_FRAME fields for IsRemote NC\_FRMTYPE\_LIN\_HEADER\_FRAME (17)

Field Name	Data Type	Description
IsRemote	NCTYPE_UINT8	<p>Value <b>17</b> represents a header frame for LIN communication. The behavior resulting from writing a header type to the LIN interface depends upon whether the <b>LIN Sleep</b> attribute is set to TRUE or FALSE (the LIN interface is asleep or awake, respectively).</p> <p>If the <b>LIN Sleep</b> attribute is set to FALSE:</p> <p>A header frame is issued when it is desired to use the LIN interface as a master, querying a slave task to publish data. Issuing a header frame causes the LIN interface to write a break-sync-id sequence to the LIN bus, with the expectation that a slave task will publish data in response. Once a header frame is issued, the LIN interface will behave as a master until the next time it is started.</p> <p>If the <b>LIN Sleep</b> attribute is set to TRUE:</p> <p>A header frame is issued when the LIN interface has been acting as a master (transmitting header and full <b>IsResponse</b> types), has been put asleep, and is desired to be used to wake the LIN bus and query a slave task to publish data. Issuing a header frame causes the LIN interface to write a wakeup break followed by break-sync-id sequence to the LIN bus, with the expectation that all slaves will wake up and a slave task will publish data in response. The LIN interface also sets the <b>LIN Sleep</b> attribute to FALSE.</p>

**Table 11-29.** NCTYPE\_CAN\_FRAME fields for IsRemote NC\_FRMTYPE\_LIN\_HEADER\_FRAME (17) (Continued)

Field Name	Data Type	Description
ArbitrationId	NCTYPE_CAN_ARBID	Zero to sixty-three.
DataLength	Array of 8 NCTYPE_UINT8	One to eight if the <b>Enable DLC Check</b> attribute is set to 1 (TRUE). If the <b>Enable DLC Check</b> attribute is set to 0 (FALSE), the data length is ignored.
Data	NCTYPE_UINT8	Ignored.

**Table 11-30.** NCTYPE\_CAN\_FRAME fields for IsRemote NC\_FRMTYPE\_LIN\_FULL\_FRAME (18)

Field Name	Data Type	Description
IsRemote	NCTYPE_UINT8	<p>Value <b>18</b> represents a full frame for LIN communication. The behavior resulting from writing a full type to the LIN interface depends upon whether the <b>LIN Sleep</b> attribute is set to TRUE or FALSE (the LIN interface is asleep or awake, respectively).</p> <p>If the <b>LIN Sleep</b> attribute is set to FALSE:</p> <p>A full frame is issued when it is desired to use the LIN interface as a master, publishing data to an external slave. Issuing a full frame causes the LIN interface slave task response queue to be updated, the master task to write a header to the LIN bus, then the LIN interface slave task to publish a response, with the expectation that one or more external slaves will subscribe to the data. Once a full frame is issued, the LIN interface will behave as a master until the next time it is started.</p> <p>If the <b>LIN Sleep</b> attribute is set to TRUE:</p> <p>A full frame is issued when the LIN interface has been acting as a master (transmitting header and full <b>IsResponse</b> types), has been put asleep, and is desired to be used to wake the LIN bus and publish data to one or more external slaves. Issuing a full frame causes the LIN interface slave task response queue to be updated, the master task to write a wakeup break followed by a header to the LIN bus, then the LIN interface slave task to publish a response, with the expectation that all slaves will wake up and one or more external slaves will subscribe to the published data. The LIN interface also sets the <b>LIN Sleep</b> attribute to FALSE.</p>
ArbitrationId	NCTYPE_CAN_ARBID	Zero to sixty-three.
DataLength	Array of 8 NCTYPE_UINT8	One to eight.
Data	NCTYPE_UINT8	Data to publish.

## CAN Object

The data type that you use with `ncWrite` of the CAN Object is `NCTYPE_CAN_DATA`. When calling `ncWrite`, you should pass size of `(NCTYPE_CAN_DATA)` for the `DataSize` parameter. Table 11-31 describes the fields of `NCTYPE_CAN_DATA`.

**Table 11-31.** NCTYPE\_CAN\_DATA Field Name

Field Name	Data Type	Description
Data	Array of 8 NCTYPE_UINT8	<p>The Data array specifies the data bytes (8 maximum). The actual number of valid data bytes depends on the CAN Object configuration specified in <code>ncConfig</code>.</p> <p>If the <code>Communication Type</code> of the CAN Object specifies <code>Receive</code>, data frames are received, not transmitted, so Data is ignored. For this <code>Communication Type</code>, the <code>ncWrite</code> function is used solely for transmission of a remote frame. If the <code>Communication Type</code> of the CAN Object specifies <code>Transmit</code>, Data must always contain <code>Data Length</code> valid bytes, where <code>Data Length</code> was configured using <code>ncConfig</code>.</p>

## ncWriteMult

---

### Purpose

Write multiple frames to a CAN or LIN Network Interface Object.

### Format

```
NCTYPE_STATUS ncWriteMult(
    NCTYPE_OBJH ObjHandle,
    NCTYPE_UINT32 DataSize,
    NCTYPE_ANY_P DataPtr);
```

### Input

`ObjHandle`

Object handle.

`DataSize`

Size of the data in bytes.

`DataPtr`

Pointer to the data to be written to the CAN Network Interface. The data consists of an array of structures, each of type `NCTYPE_CAN_STRUCT`.

Within each structure, `FrameType` indicates the frame type. The frame type determines the interpretation of the remaining fields. For a description of each frame type, refer to the [Frame Types](#) section of this function reference.

The maximum number of structures you can provide to each `ncWriteMult` is 512. For more information, refer to the [Writing Large Numbers of Frames](#) section of this function reference.

### Output

#### Return Value

Status of the function call, returned as a signed 32-bit integer. Zero means the function executed successfully. Negative specifies an error, meaning the function did not perform expected behavior. Positive specifies a warning, meaning the function performed as expected, but a condition arose that might require attention. For more information, refer to [ncStatusToString](#).

## Description

You use `ncWriteMult` to place one or more frames into the Network Interface write queue. This function does not wait for the frames to be transmitted on the network. This function is not supported for CAN Objects.

### Timestamped Transmit

In addition to supporting multiple frames, this function is preferable to `ncWrite` in that it supports timestamped frames. To enable timestamped transmit, use `ncSetAttribute` to set the `NC_ATTR_TRANSMIT_MODE` (Transmit Mode) attribute to Timestamped Transmit mode (1).

In Timestamped Transmit mode, NI-CAN times the transmission according to the difference in timestamps between consecutive frames. For example, if every frame provided to `ncWriteMult` increments by 10 milliseconds, the frames will be transmitted with a 10 millisecond gap.

If the timestamp of one frame is less than the timestamp of the preceding frame, the timeline is reset, and both frames transmit back to back. For example, if you write a frame with relative timestamp 30 ms followed by a frame with timestamp 15 ms, the two frames will be transmitted back to back. This sort of behavior can occur when you transmit a logfile of timestamped frames repeatedly, because on the second traversal of the logfile, the timestamp of the first frame will be less than the timestamp of the last frame.

The first frame that you provide to `ncWriteMult` always transmits immediately, regardless of its timestamp. If you need to delay transmission of first frame after start, you can write a Delay frame or Start Trigger frame as described in the *Frame Types* section of this function reference.

**Timestamped Transmit** applies only to Series 1 and Series 2 interfaces.

847x CAN and LIN products do not support timestamped transmit. These products ignore the timestamp provided in the cluster for `ncWriteMult`. If you use `ncWriteMult` to write header and full frame types out of the USB LIN acting as master, then the frames will be transmitted together as closely as possible. If you use `ncWriteMult` to write response frame types to the LIN interface acting as slave, then the frames will be loaded into the response table as quickly as possible.

### Immediate Transmit

The default value for the `NC_ATTR_TRANSMIT_MODE` (Transmit Mode) attribute is Immediate Transmit mode (0). You can also use `ncSetAttribute` to set the `NC_ATTR_TRANSMIT_MODE` attribute to Immediate Transmit mode.

In Immediate Transmit mode, NI-CAN ignores the timestamp in each frame, and transmits the frames as fast as possible. This behavior is equivalent to the `ncWrite` function, except that you can write multiple frames for transmission in quick succession.

## Writing Large Numbers of Frames

Although NI-CAN provides a large write queue to store frames pending transmission, writing timestamped frames from a logfile with thousands of frames can eventually fill this queue.

When the Network Interface write queue cannot hold all frames provided, `ncWriteMult` returns an overflow error. When this overflow error is returned, none of the frames provided in the array referenced by `DataPtr` have been written. This enables your application to try the same array again at a later time.

To determine when adequate space is available in the write queue to retry `ncWriteMult` after an overflow, you can use `ncWaitForState` with the `NC_ST_WRITE_MULT` (Write Multiple) state. The `NC_ST_WRITE_MULT` state will transition from false to true when space is available for at least 512 frames. Since you must limit the array passed to `ncWriteMult` to 512 frames or less, the `NC_ST_WRITE_MULT` state indicates that a retry will succeed.

Another technique to recover from a write queue overflow is to use `ncGetAttribute` with the `NC_ATTR_WRITE_ENTRIES_FREE` (Write Entries Free) attribute. Although this technique requires you to call `ncGetAttribute` periodically until the desired number of frame entries is available, it avoids the need to determine a proper Timeout for `ncWaitForState`. When the time difference between frames varies from milliseconds to seconds, it may be difficult to determine how long to wait for entries to become available.

After writing a sequence of timestamped frames with `ncWriteMult`, you cannot close the Network Interface, because you must wait for the last timestamped frame to transmit onto the network. You can wait for the final transmit to complete using `ncWaitForState` with the `NC_ST_WRITE_SUCCESS` (Write Success) state. You can also use `ncGetAttribute` with the `NC_ATTR_WRITE_PENDING` (Write Entries Pending) attribute to query periodically, which provides the option of aborting the timestamped transmission by closing the Network Interface.

## Frame Types

Within each structure (type `NCTYPE_CAN_STRUCT`) of the array referenced by `DataPtr`, `FrameType` indicates the frame type. The frame type determines the interpretation of the remaining fields. Table 11-32, *Structure with FrameType value NC\_FRMTYPE\_DATA (0): CAN Data Frame*, Table 11-33, *Structure with FrameType value NC\_FRMTYPE\_REMOTE (1): CAN Remote Frame*, Table 11-34, *Structure with FrameType value NC\_FRMTYPE\_START\_TRIG (4): Start Trigger Frame*, Table 11-35, *Structure with FrameType value NC\_FRMTYPE\_DELAY (5): Delay Frame*, Table 11-36, *FrameType Value NC\_FRMTYPE\_LIN\_RESPONSE\_ENTRY (16): LIN Response Entry Frame*, Table 11-37,



*FrameType* Value `NC_FRMTYPE_LIN_HEADER (17)`: *LIN Header Frame*, and Table 11-38, *FrameType* Value `NC_FRMTYPE_LIN_FULL (18)`: *LIN Full Frame*, describe the fields of the structure for each value of `FrameType`.

To determine if your hardware supports one of the following frame types for this function, refer to Appendix D, *Frame Types for CAN and LIN Hardware*.

**Table 11-32.** Structure with `FrameType` value `NC_FRMTYPE_DATA (0)`: CAN Data Frame

Field Name	Data Type	Description
<code>FrameType</code>	<code>NCTYPE_UINT8</code>	Value <code>NC_FRMTYPE_DATA (0)</code> specifies a CAN data frame.  The CAN data frame transfers data on the network.
<code>ArbitrationId</code>	<code>NCTYPE_CAN_ARBID</code>	Specifies the arbitration ID to transmit in the CAN data frame. A standard ID (11-bit) is specified by default. In order to specify an extended ID (29-bit), OR in the bit mask <code>NC_FL_CAN_ARBID_XTD (20000000 hex)</code> .
<code>DataLength</code>	<code>NCTYPE_UINT8</code>	Specifies the number of bytes in the <code>Data</code> array to transmit in the CAN data frame.
<code>Data</code>	Array of 8, <code>NCTYPE_UINT8</code>	Data bytes to transmit in the CAN data frame.
<code>Timestamp</code>	<code>NCTYPE_ABS_TIME</code>	If the <code>NC_ATTR_TRANSMIT_MODE (Transmit Mode)</code> attribute is <code>Immediate Transmit (default)</code> , this field is ignored, and CAN frames transmit as quickly as possible.  If the <code>NC_ATTR_TRANSMIT_MODE</code> attribute is <code>Timestamped Transmit (1)</code> , this field specifies a timestamp. The timestamp is used to time transmission of CAN frames as described in the <i>Timestamped Transmit</i> section of this function reference. The timestamp data type <code>NCTYPE_ABS_TIME</code> is a 64-bit unsigned integer in 100 nanosecond increments. The format of the time is absolute (time and date) or relative (zero based) depending on the <code>NC_ATTR_TIMESTAMP_FORMAT (Timestamp Format)</code> attribute. Refer to <code>ncSetAttribute</code> for more information on timestamps.

**Table 11-33.** Structure with FrameType value NC\_FRMTYPE\_REMOTE (1): CAN Remote Frame

Field Name	Data Type	Description
FrameType	NCTYPE_UINT8	Value NC_FRMTYPE_REMOTE (1) specifies a CAN remote frame.  The CAN remote frame requests data for its arbitration ID.
ArbitrationId	NCTYPE_CAN_ARBID	Specifies the arbitration ID to transmit in the CAN data frame. A standard ID (11-bit) is specified by default. In order to specify an extended ID (29-bit), OR in the bit mask NC_FL_CAN_ARBID_XTD (20000000 hex).
DataLength	NCTYPE_UINT8	Specifies the number of bytes requested. The value is transmitted in the CAN remote frame, but with no data.
Data	Array of 8, NCTYPE_UINT8	Ignored. No data bytes are contained in a CAN remote frame.
Timestamp	NCTYPE_ABS_TIME	If the NC_ATTR_TRANSMIT_MODE (Transmit Mode) attribute is Immediate Transmit (default), this field is ignored, and CAN frames transmit as quickly as possible.  If the NC_ATTR_TRANSMIT_MODE attribute is Timestamped Transmit (1), this field specifies a timestamp. The timestamp is used to time transmission of CAN frames as described in the <i>Timestamped Transmit</i> section of this function reference. The timestamp data type NCTYPE_ABS_TIME is a 64-bit unsigned integer in 100 nanosecond increments. The format of the time is absolute (time and date) or relative (zero based) depending on the NC_ATTR_TIMESTAMP_FORMAT (Timestamp Format) attribute. Refer to <a href="#">ncSetAttribute</a> for more information on timestamps.

**Table 11-34.** Structure with FrameType value NC\_FRMTYPE\_START\_TRIG (4): Start Trigger Frame

Field Name	Data Type	Description
FrameType	NCTYPE_UINT8	<p>Value NC_FRMTYPE_START_TRIG (4) specifies a start trigger frame.</p> <p>When you use <code>ncWriteMult</code> to write frames from a logfile for timestamped transmit, you can write the start trigger frame as the first frame. The start trigger frame reproduces the delay from start of communication to the first CAN frame. For example, if you write a start trigger frame followed by a CAN data frame with relative timestamp 20 ms, NI-CAN will delay 20 ms before transmitting the CAN data frame. If you write the CAN data frame without the start trigger frame, NI-CAN will transmit the CAN data frame immediately.</p>
ArbitrationId	NCTYPE_CAN_ARBITID	Value 0 is required.
DataLength	NCTYPE_UINT8	Value 1 is required.

**Table 11-34.** Structure with FrameType value NC\_FRMTYPE\_START\_TRIG (4): Start Trigger Frame (Continued)

Field Name	Data Type	Description
Data	Array of 8, NCTYPE_UINT8	The single data byte in the array specifies the Timestamp Format NC_ATTR_TIMESTAMP_FORMAT (defined in <a href="#">ncSetAttribute</a> ) to be used for all subsequent CAN frames. The value is 0 for absolute timestamps, and 1 for relative timestamps. In order for NI-CAN to delay the proper time for the start trigger, this timestamp format must match the format used in all subsequent frames provided to <code>ncWriteMult</code> .
Timestamp	NCTYPE_ABS_TIME	<p>Absolute timestamp of the start trigger. Within a logfile, this timestamp indicates the date and time at which CAN communication started.</p> <p>The timestamp data type <code>NCTYPE_ABS_TIME</code> is a 64-bit unsigned integer in 100 nanosecond increments. The format of this timestamp is always absolute, even when <code>Data</code> byte 0 specifies relative timestamp format. This absolute timestamp provides data/time information even when the CAN frames of a logfile use the relative format. When <code>Data</code> byte 0 specifies absolute format (0), the difference between this timestamp and the absolute timestamp of the subsequent CAN frame is used as the delay for transmit of that CAN frame. When <code>Data</code> byte 0 specifies relative format (1), this timestamp is ignored by NI-CAN, and the relative timestamp of the subsequent CAN frame is used as the transmit delay.</p>

**Table 11-35.** Structure with FrameType value NC\_FRMTYPE\_DELAY (5): Delay Frame

Field Name	Data Type	Description
FrameType	NCTYPE_UINT8	Value NC_FRMTYPE_DELAY (5) specifies a delay frame.  Use the delay frame to insert an additional delay between any two timestamped frames. For example, if you write a CAN frame with relative timestamp 20 ms, followed by a delay frame of 30 ms, followed by a CAN frame with timestamp 55 ms, NI-CAN will transmit the CAN frames 65 ms apart.
ArbitrationId	NCTYPE_CAN_ARBITID	Value 0 is required.
DataLength	NCTYPE_UINT8	Value 0 is required.
Data	Array of 8, NCTYPE_UINT8	Ignored.
Timestamp	NCTYPE_ABS_TIME	Specifies the delay to insert (not a timestamp).  The delay is a 64-bit unsigned integer in 100 nanosecond increments. For example, a delay of 10 ms would be specified as the number 100000 in the low 32 bits of <code>Timestamp</code> . The maximum delay supported is 180.0 seconds (3 minutes).

**Table 11-36.** FrameType Value NC\_FRMTYPE\_LIN\_RESPONSE\_ENTRY (16): LIN Response Entry Frame

Field Name	Data Type	Description
FrameType	NCTYPE_UINT8	<p>Value 16 represents a response entry frame for LIN communication. The behavior resulting from writing a response type to the LIN interface depends upon whether the LIN Sleep attribute is set to TRUE or FALSE (the LIN interface is asleep or awake, respectively).</p> <p>If the NC_ATTR_LIN_SLEEP attribute is set to FALSE:</p> <p>A response entry frame is issued when it is desired to configure the LIN interface slave task to subscribe to or publish data, in response to a particular header ID received from a master task. Each response entry frame indicates the ID of the header for which it is to respond, whether the response is to publish data or subscribe to data, and if it is to publish data, the data length code (DLC) and data values. The DLC determines whether the response will be to subscribe (DLC = 0), or publish (DLC = data length), in response to a header containing the ID of the response frame. Sixty-four response entry frames (one for each of the sixty-four LIN IDs) may be written to the response queue in the LIN interface. When the Network Interface is created or reset, the interface is reset to act as a slave and to respond as subscriber to data for all LIN IDs.</p> <p>If the NC_ATTR_LIN_SLEEP attribute is set to TRUE:</p> <p>A response entry frame is issued when the LIN interface has been acting as a slave (processing master headers), has been put asleep, and is desired to be used to wake the bus and initiate the transmission of headers by the master. When the response entry type is written to the LIN interface, two things occur. First, the response queue is loaded with the ID, DLC, and data (if DLC is non-zero meaning the response is to publish), of the response entry frame. Next the interface transmits a wakeup break on the bus. Per the LIN specification, it either waits until the master acknowledges the wakeup break by writing a header within the specified time, or re-transmits the wakeup break if it does not. When the master responds with a header, the LIN interface sets the LIN Sleep attribute to FALSE, and responds to the ID contained in the header in the manner (publish or subscribe) specified for that ID in the response queue.</p>
ArbitrationId	NCTYPE_CAN_ARBITID	Zero to sixty-three.
DataLength	NCTYPE_UINT8	Zero if the response is to subscribe to data. Actual length of <b>Data</b> if the response is to publish data.

**Table 11-36.** FrameType Value NC\_FRMTYPE\_LIN\_RESPONSE\_ENTRY (16): LIN Response Entry Frame

Field Name	Data Type	Description
Data	Array of 8, NCTYPE_UINT8	Ignored if <b>DataLength</b> is zero. Data to publish if <b>DataLength</b> is non-zero.
Timestamp	NCTYPE_ABS_TIME	Ignored.

**Table 11-37.** FrameType Value NC\_FRMTYPE\_LIN\_HEADER (17): LIN Header Frame

Field Name	Data Type	Description
FrameType	NCTYPE_UINT8	<p>Value 17 represents a header frame for LIN communication. The behavior resulting from writing a header type to the LIN interface depends upon whether the NC_ATTR_LIN_SLEEP attribute is set to TRUE or FALSE (the LIN interface is asleep or awake, respectively).</p> <p>If the NC_ATTR_LIN_SLEEP attribute is set to FALSE: A header frame is issued when it is desired to use the LIN interface as a master, querying a slave task to publish data. Issuing a header frame causes the LIN interface to write a break-sync-id sequence to the LIN bus, with the expectation that a slave task will publish data in response. Once a header frame is issued, the LIN interface will behave as a master until the next time it is started.</p> <p>If the NC_ATTR_LIN_SLEEP attribute is set to TRUE: A header frame is issued when the LIN interface has been acting as a master (transmitting header and full <b>IsResponse</b> types), has been put asleep, and is desired to be used to wake the LIN bus and query a slave task to publish data. Issuing a header frame causes the LIN interface to write a wakeup break followed by break-sync-id sequence to the LIN bus, with the expectation that all slaves will wake up and a slave task will publish data in response. The LIN interface also sets the NC_ATTR_LIN_SLEEP attribute to FALSE.</p>
ArbitrationId	NCTYPE_CAN_ARBITID	Zero to sixty-three.

**Table 11-37.** FrameType Value NC\_FRMTYPE\_LIN\_HEADER (17): LIN Header Frame (Continued)

Field Name	Data Type	Description
DataLength	NCTYPE_UINT8	One to eight if the NC_ATTR_ENABLE_DLC_CHECK attribute is set to 1 (TRUE). If the NC_ATTR_ENABLE_DLC_CHECK attribute is set to 0 (FALSE), the data length is ignored.
Data	Array of 8, NCTYPE_UINT8	Ignored.
Timestamp	NCTYPE_ABS_TIME	Ignored.



**Table 11-38.** FrameType Value NC\_FRMTYPE\_LIN\_FULL (18): LIN Full Frame

Field Name	Data Type	Description
FrameType	NCTYPE_UINT8	<p>Value 18 represents a full frame for LIN communication. The behavior resulting from writing a full type to the LIN interface depends upon whether the NC_ATTR_LIN_SLEEP attribute is set to TRUE or FALSE (the LIN interface is asleep or awake, respectively).</p> <p>If the NC_ATTR_LIN_SLEEP attribute is set to FALSE:</p> <p>A full frame is issued when it is desired to use the LIN interface as a master, publishing data to an external slave. Issuing a full frame causes the LIN interface slave task response queue to be updated, the master task to write a header to the LIN bus, then the LIN interface slave task to publish a response, with the expectation that one or more external slaves will subscribe to the data. Once a full frame is issued, the LIN interface will behave as a master until the next time it is started.</p> <p>If the NC_ATTR_LIN_SLEEP attribute is set to TRUE:</p> <p>A full frame is issued when the LIN interface has been acting as a master (transmitting header and full <b>IsResponse</b> types), has been put asleep, and is desired to be used to wake the LIN bus and publish data to one or more external slaves. Issuing a full frame causes the LIN interface slave task response queue to be updated, the master task to write a wakeup break followed by a header to the LIN bus, then the LIN interface slave task to publish a response, with the expectation that all slaves will wake up and one or more external slaves will subscribe to the published data. The LIN interface also sets the NC_ATTR_LIN_SLEEP attribute to FALSE.</p>
ArbitrationId	NCTYPE_CAN_ARBID	Zero to sixty-three.
DataLength	NCTYPE_UINT8	One to eight.
Data	Array of 8, NCTYPE_UINT8	Data to publish.
Timestamp	NCTYPE_ABS_TIME	Ignored.

---

# Troubleshooting and Common Questions

This appendix describes how to troubleshoot problems with the NI-CAN software and answers some common questions.

## Troubleshooting with the Measurement & Automation Explorer (MAX)

---

MAX contains configuration information for all CAN and LIN hardware installed on the system. To start MAX, double-click on the **Measurement & Automation** icon on the desktop. Your NI-CAN cards are listed in the left pane (Configuration) under **Devices and Interfaces**.

You can test the CAN and LIN interfaces by choosing **Tools»NI-CAN» Test All Local Cards** from the menu, or you can right-click on a CAN or LIN interface and choose **Self Test**. If the Self Test fails, refer to the [Troubleshooting Self Test Failures](#) section of this appendix.

If there is no **National Instruments CAN Interfaces** item, and you have an NI-CAN card installed, refer to the [Missing CAN or LIN Interface](#) section of this appendix.

### Missing CAN or LIN Interface

If you have a CAN or LIN interface installed, but no interface appears in the configuration section of MAX under **Devices and Interfaces**, you need to search for hardware changes by pressing the <F5> key or choosing the **Refresh** option from the **View** menu in MAX.

If the interface still doesn't show up, you may have a resource conflict in the Windows Device Manager. Refer to the documentation for the Windows operating system for instructions on how to resolve the problem using the Device Manager.

# Troubleshooting Self Test Failures

---

The following sections explain common error messages generated by the NI-CAN Self Test.



**Note** All references to NI-CAN hardware include CAN and LIN.

## Application In Use

This error occurs if you are running an application that is already using the NI-CAN card. The self test aborts in order to avoid adversely affecting the application. Before running the self test, exit all applications that use NI-CAN. If you are using LabVIEW, you may need to exit LabVIEW in order to unload the NI-CAN driver.

## Memory Resource Conflict

This error occurs if the memory resource assigned to an NI-CAN card conflicts with the memory resources being used by other devices in the system. Resource conflicts typically occur when the system contains legacy boards that use resources not properly reserved with the Device Manager. If a resource conflict exists, write down the memory resource that caused the conflict and refer to the documentation for the Windows operating system for instructions on how to use the Device Manager to reserve memory resources for legacy boards. After the conflict has been resolved, run the NI-CAN Self Test again.

## Interrupt Resource Conflict

This error occurs if the interrupt resource assigned to an NI-CAN card conflicts with the interrupt resources being used by other devices in the system. Resource conflicts typically occur when the system contains legacy boards that use resources not properly reserved with the Device Manager. If a resource conflict exists, write down the interrupt resource that caused the conflict and refer to the documentation for the Windows operating system for instructions on how to use the Device Manager to reserve interrupt resources for legacy boards. After the conflict has been resolved, run the NI-CAN Self Test again.

## NI-CAN Software Problem Encountered

This error occurs if the NI-CAN Self Test detects that it is unable to communicate correctly with the NI-CAN hardware using the installed NI-CAN software. If you get this error, shut down the computer, restart it, and run the NI-CAN Self Test again.

If the error continues after restart, uninstall NI-CAN and then reinstall.

## NI-CAN Hardware Problem Encountered

This error occurs if the NI-CAN Self Test detects a defect in the NI-CAN hardware. If you get this error, write down the numeric code shown with the error, and contact National Instruments.

## Common Questions

---

### **How can I determine which version of the NI-CAN software is installed on my system?**

Within MAX, select **My System»Software»NI-CAN** within the configuration window. The version is displayed at the right side next to the configuration window.

### **How many CAN cards can I configure for use with my NI-CAN software?**

The NI-CAN software can be configured to communicate with up to 32 NI-CAN cards on all supported operating systems.

### **Are interrupts required for the NI-CAN cards?**

Yes, one interrupt per card is required. However, PCI and PXI CAN cards can share interrupts with other devices in the system.

### **How do I use a baud rate that is not listed by NI-CAN?**

Within MAX, you select the baud rate in the **Properties** of each CAN port. Select the **Advanced** button to specify an unlisted rate. Within the application, you can use the hexadecimal baud rate of 0x8000zzyy, where yy is the desired value for Bit Timing Register 0 (BTR0), and zz is the desired value for Bit Timing Register 1 (BTR1) of the CAN controller. For assistance with creating BTR values, use the advanced dialog referenced for MAX.

**Can I use the Channel API and the Frame API at the same time?**

Yes, you can use the Channel API and the Frame API at the same time, but only on different ports. For example, you can use the Frame API on port 1 of a 2-port NI-CAN card and the Channel API on port 2 of that card.

**Can High-Speed NI-CAN cards and low-speed NI-CAN cards be used on the same network?**

No. This is not possible due to different termination requirements of High-Speed and low-speed CAN devices. Refer to the *High-Speed CAN Pinout Cable* and *Low-Speed/Fault-Tolerant CAN Pinout Cable* sections of Chapter 4, *Connectors and Cables*, for more information.

**Do NI-CAN cards support a listen-only mode?**

Yes, Series 2, 847x, and 847x with Sync CAN interfaces support a listen-only mode, where the CAN card does not interact with the CAN bus, (that is, does not acknowledge incoming CAN frames).

**Does the NI-CAN card provide power to the CAN bus?**

No. To provide power to the CAN bus, you need an external power supply.

**Why can't I communicate with other devices on the CAN bus, even though the self test in MAX passed?**

If you have a Series 1 card, check the settings for the power source jumper. The EXT position is required for low-speed cards; High-Speed cards should have the power source jumper set to INT. For more information, refer to Chapter 4, *Connectors and Cables*. If the jumper settings are correct, or you are using Series 2 CAN cards, the network may have a cabling or termination problem. Refer to Chapter 3, *NI CAN and LIN Hardware*, for more information. In addition, consult the documentation for the CAN nodes to ensure that the baud rate is exactly the same as you specify in MAX and/or the application code.

**Why are components left after the NI-CAN software is uninstalled?**

The uninstall program removes only items that the installation program installed. If you add anything to a directory that the installation program created, the uninstall program does not delete that directory, because the directory is not empty after the uninstallation. You must remove any remaining components yourself.

**Why do I not see the new feature properties in LabVIEW when I upgrade to a newer NI-CAN driver version?**

NI-CAN 2.4 (or newer) includes several new Frame API attributes. If you have a LabVIEW VI written for an earlier version of NI-CAN, upgrading to NI-CAN 2.4 (or newer) will not automatically update constants or controls for the **AttrId** input. To use the new attributes, replace your older constants and controls using the **AttrId** input of the updated NI-CAN VIs. If you do not want to use new Frame API attributes, you can continue to use the older constants and controls for compatibility. This issue does not apply to the Channel API for LabVIEW. Because the Get/Set Property functions are provided as polymorphic VIs, they are automatically updated.

**What is special to NI USB 847x devices?**

For USB-LIN interfaces, the LIN bus must be terminated. This is typically done at the master node. For information about how to enable or disable termination on the USB-LIN, refer to the `ncSetAttribute` function with the Frame API.

The USB-LIN interfaces require external power of 8–18 V. For more details on the power requirements, refer to the USB-LIN specifications sections.

The USB LED quickly switches between green and amber when the hardware is first detected.

If you are using the USB CAN or LIN products with a USB hub, the hub must be powered.

Due to the inherent latencies of the Universal Serial Bus (USB), data or states received by the NI USB 847x Series devices might be processed by the driver on the host side later than data from a plug-in (PCI, PXI, or PCMCIA) interface. This does not affect the timestamps, as those are generated on the hardware, but could cause timeout failures with the NI USB 847x Series devices that will not happen on plug-in hardware. To avoid these failures, increase the timeout value for functions that perform a wait for a certain state.

NI USB-847x devices do not support the NI-CAN Channel API.

NI USB-847x devices do not support the CAN Object-related subset of the NI-CAN Frame API functions.

The following overview describes the subset of the Frame API features you can use with USB CAN and USB LIN products. The overview applies to LabVIEW, C/C++ and VB.

Supported functions:

- `ncAction` (refer to the limitations listed below)
- `ncClose`
- `ncConnectTerminals/ncDisconnectTerminals` (refer to the limitations listed below)
- `ncGetAttr/ncSetAttr` (refer to the limitations listed below)
- `ncOpen`
- `ncConfigCANNet` (refer to the limitations listed below)
- `ncReadNet/ncReadNetMult`
- `ncWaitForState` (refer to the limitations listed below)
- `ncWriteNet/ncWriteNetMult` (refer to the limitations listed below)

Limitations:

- `ncAction`: The Output On RTSI Line action is not supported.
- `ncConnectTerminals/ncDisconnectTerminals`: For the devices with synchronization, the following source/destination terminals are supported:
  - RTSI0: Used to import/export a start trigger from another device.
  - RTSI7/RTSI Clock: Used to import/export a timebase from another device.
  - 20 MHz Timebase/Master Timebase: Used to export/import a timebase to another device.
  - Start Trigger: Used to export/import a start trigger to another device.
- `ncGetAttr/ncSetAttr`: All CAN Object or RTSI-related properties are not supported.
- `ncConfigCANNet`: Only the **Baudrate** and **StartOnOpen** attributes are used; other values are ignored.
- `ncWaitForState`: The Read Multiple and Write Multiple states are not supported.
- `ncWriteNetMult`: Timestamped transmit is not supported, so the timestamp provided in the cluster is always ignored for USB products.

---

## Summary of the CAN Standard

This appendix provides a summary of the CAN standard.

### History and Use of CAN

---

In the past few decades, advances in automotive technology have led to increased use of electronic control systems for engine timing, anti-lock brake systems, and distributorless ignition. With conventional wiring, data is exchanged in these systems using dedicated signal lines. As the complexity and number of devices has increased, using dedicated signal lines becomes increasingly difficult and expensive.

To overcome the limitations of conventional automotive wiring, Bosch developed the Controller Area Network (CAN) in the mid-1980s. Using CAN, devices (controllers, sensors, and actuators) are connected on a common serial bus. This network of devices can be thought of as a scaled-down, real-time, low-cost version of networks used to connect personal computers. Any device on a CAN network can communicate with any other device using a common pair of wires.

As CAN implementations increased in the automotive industry, CAN was standardized internationally as ISO 11898. CAN chips were created by major semiconductor manufacturers such as Intel, Motorola, and Philips. With these developments, manufacturers of industrial automation equipment began to consider CAN for use in industrial applications. Comparison of the requirements for automotive and industrial device networks showed numerous similarities, including the transition away from dedicated signal lines, low cost, resistance to harsh environments, and high real-time capabilities.

Because of these similarities, CAN became widely used in photoelectric sensors and motion controllers for textile machinery, packaging machines, and production line equipment. By the mid-1990s, CAN was specified as the basis of many industrial device networking protocols, including DeviceNet, and CANopen.



With its growing popularity in automotive and industrial applications, CAN has been increasingly used in a wide variety of diverse applications. Use in agricultural equipment, nautical machinery, medical apparatus, semiconductor manufacturing equipment, and machine tools testify to the versatility of CAN.

## CAN Identifiers and Message Priority

---

When a CAN device transmits data onto the network, an identifier that is unique throughout the network precedes the data. The identifier defines not only the content of the data, but also the priority.

When a device transmits a message onto the CAN network, all other devices on the network receive that message. Each receiving device performs an acceptance test on the identifier to determine if the message is relevant to it. If the received identifier is not relevant to the device (such as RPM received by an air conditioning controller), the device ignores the message.

When more than one CAN device transmits a message simultaneously, the identifier is used as a priority to determine which device gains access to the network. The lower the numerical value of the identifier, the higher its priority.

Figure B-1 shows two CAN devices attempting to transmit messages, one using identifier 647 hex, and the other using identifier 6FF hex. As each device transmits the 11 bits of its identifier, it examines the network to determine if a higher-priority identifier is being transmitted simultaneously. If an identifier collision is detected, the losing device(s) immediately stop transmission, and wait for the higher-priority message to complete before automatically retrying. Because the highest priority identifier continues its transmission without interruption, this scheme is referred to as *nondestructive bitwise arbitration*, and CAN's identifier is often referred to as an *arbitration ID*. This ability to resolve collisions and continue with high-priority transmissions is one feature that makes CAN ideal for real-time applications.

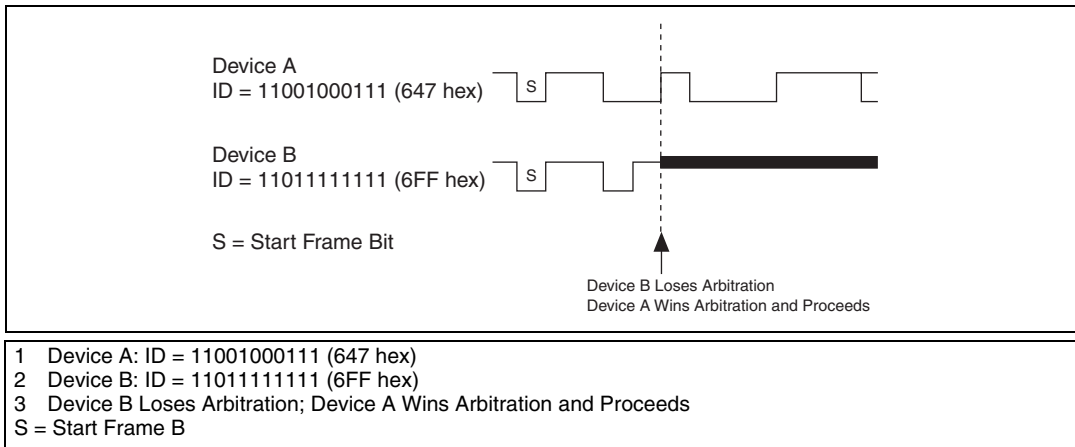

Figure B-1. Example of CAN Arbitration

## CAN Frames

In a CAN network, the messages transferred across the network are called frames. The CAN protocol supports two frame formats as defined in the Bosch version 2.0 specifications, the essential difference being in the length of the arbitration ID. In the standard frame format (also known as 2.0A), the length of the ID is 11 bits. In the extended frame format (also known as 2.0B), the length of the ID is 29 bits. Figure B-2 shows the essential fields of the standard and extended frame formats, and the following sections describe each field.

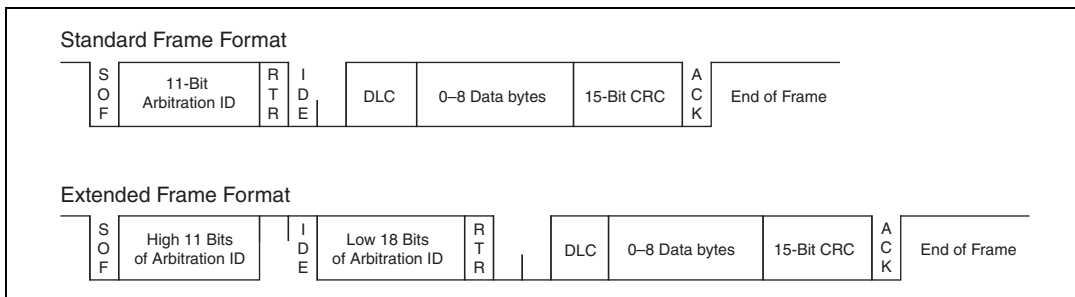

Figure B-2. Standard and Extended Frame Formats

## Start of Frame (SOF)

Start of Frame is a single bit (0) that marks the beginning of a CAN frame.

## Arbitration ID

The arbitration ID fields contain the identifier for a CAN frame. The standard format has one 11-bit field, and the extended format has two fields, which are 11 and 18 bits in length. In both formats, bits of the arbitration ID are transmitted from high to low order.

## Remote Transmit Request (RTR)

The Remote Transmit Request bit is dominant (0) for data frames, and recessive (1) for remote frames. Data frames are the fundamental means of data transfer on a CAN network, and are used to transmit data from one device to one or more receivers. A device transmits a remote frame to request transmission of a data frame for the given arbitration ID. The remote frame is used to request data from its source device, rather than waiting for the data source to transmit the data on its own.

## Identifier Extension (IDE)

The Identifier Extension bit differentiates standard frames from extended frames. Because the IDE bit is dominant (0) for standard frames and recessive (1) for extended frames, standard frames are always higher priority than extended frames.

## Data Length Code (DLC)

The Data Length Code is a 4-bit field that indicates the number of data bytes in a data frame. In a remote frame, the Data Length Code indicates the number of data bytes in the requested data frame. Valid Data Length Codes range from zero to eight.

## Data Bytes

For data frames, this field contains from 0 to 8 data bytes. Remote CAN frames always contain zero data bytes.

## Cyclic Redundancy Check (CRC)

The 15-bit Cyclic Redundancy Check detects bit errors in frames. The transmitter calculates the CRC based on the preceding bits of the frame, and all receivers recalculate it for comparison. If the CRC calculated by a receiver differs from the CRC in the frame, the receiver detects an error.

## Acknowledgment Bit (ACK)

All receivers use the Acknowledgment Bit to acknowledge successful reception of the frame. The ACK bit is transmitted recessive (1), and is overwritten as dominant (0) by all devices that receive the frame successfully. The receivers acknowledge correct frames regardless of the acceptance test performed on the arbitration ID. If the transmitter of the frame detects no acknowledgment, it could mean that the receivers detected an error (such as a CRC error), the ACK bit was corrupted, or there are no receivers (for example, only one device on the network). In such cases, the transmitter automatically retransmits the frame.

## End of Frame

Each frame ends with a sequence of recessive bits. After the required number of recessive bits, the CAN bus is idle, and the next frame transmission can begin.

## CAN Error Detection and Confinement

---

One of the most important and useful features of CAN is its high reliability, even in extremely noisy environments. CAN provides a variety of mechanisms to detect errors in frames. This error detection is used to retransmit the frame until it is received successfully. CAN also provides an error confinement mechanism used to remove a malfunctioning device from the CAN network when a high percentage of its frames result in errors. This error confinement prevents malfunctioning devices from disturbing the overall network traffic.

## Error Detection

Whenever any CAN device detects an error in a frame, that device transmits a special sequence of bits called an error flag. This error flag is normally detected by the device transmitting the invalid frame, which then retransmits to correct the error. The retransmission starts over from the start of frame, and thus arbitration with other devices can occur again.

CAN devices detect the following errors, which are described in the following sections:

- Bit error
- Stuff error
- CRC error
- Form error
- Acknowledgment error

## Bit Error

During frame transmissions, a CAN device monitors the bus on a bit-by-bit basis. If the bit level monitored is different from the transmitted bit, a bit error is detected. This bit error check applies only to the Data Length Code, Data Bytes, and Cyclic Redundancy Check fields of the transmitted frame.

## Stuff Error

Whenever a transmitting device detects five consecutive bits of equal value, it automatically inserts a complemented bit into the transmitted bit stream. This stuff bit is automatically removed by all receiving devices. The bit stuffing scheme is used to guarantee enough edges in the bit stream to maintain synchronization within a frame.

A stuff error occurs whenever six consecutive bits of equal value are detected on the bus.

## CRC Error

A CRC error is detected by a receiving device whenever the calculated CRC differs from the actual CRC in the frame.

## Form Error

A form error occurs when a violation of the fundamental CAN frame encoding is detected. For example, if a CAN device begins transmitting the Start Of Frame bit for a new frame before the End Of Frame sequence completes for a previous frame (does not wait for bus idle), a form error is detected.

## Acknowledgment Error

An acknowledgment error is detected by a transmitting device whenever it does not detect a dominant Acknowledgment Bit (ACK).

## Error Confinement

To provide for error confinement, each CAN device must implement a transmit error counter and a receive error counter. The transmit error counter is incremented when errors are detected for transmitted frames, and decremented when a frame is transmitted successfully. The receive error counter is used for received frames in much the same way. The error counters are increased more for errors than they are decreased for successful reception/transmission. This ensures that the error counters will generally increase when a certain ratio of frames (roughly 1/8) encounter

errors. By maintaining the error counters in this manner, the CAN protocol can generally distinguish temporary errors (such as those caused by external noise) from permanent failures (such as a broken cable). For complete information on the rules used to increment/decrement the error counters, refer to the CAN specification (ISO 11898).

With regard to error confinement, each CAN device may be in one of three states: error active, error passive, and bus off.

## Error Active State

When a CAN device is powered on, it begins in the error active state. A device in error active state can normally take part in communication, and transmits an active error flag when an error is detected. This active error flag (sequence of dominant 0 bits) causes the current frame transmission to abort, resulting in a subsequent retransmission. A CAN device remains in the error active state as long as the transmit and receive error counters are both below 128. In a normally functioning network of CAN devices, all devices are in the error active state.

## Error Passive State

If either the transmit error counter or the receive error counter increments above 127, the CAN device transitions into the error passive state. A device in error passive state can still take part in communication, but transmits a passive error flag when an error is detected. This passive error flag (sequence of recessive 1 bits) generally does not abort frames transmitted by other devices. Since passive error flags cannot prevail over any activity on the bus line, they are noticed only when the error passive device is transmitting a frame. Thus, if an error passive device detects a receive error on a frame which is received successfully by other devices, the frame is not retransmitted.

One special rule to keep in mind: When an error passive device detects an acknowledgment error, it does not increment its transmit error counter. Thus, if a CAN network consists of only one device (for example, if you do not connect a cable to the National Instruments CAN interface), and that device attempts to transmit a frame, it retransmits continuously but never goes into bus off state (although it eventually reaches error passive state).

## Bus Off State

If the transmit error counter increments above 255, the CAN device transitions into the bus off state. A device in the bus off state does not transmit or receive any frames, and thus cannot have any influence on the bus. The bus off state is used to disable a malfunctioning CAN device which frequently transmits invalid frames, so that the device does not adversely affect other devices on the network. When a CAN device transitions to bus off, it can be placed back into error active state (with both counters reset to zero) only by manual intervention. For sensor/actuator types of devices, this often involves powering the device off then on. For NI-CAN network interfaces, communication can be started again using an API function.

## Low-Speed CAN

---

Low-speed CAN is commonly used to control “comfort” devices in an automobile, such as seat adjustment, mirror adjustment, and door locking. It differs from “High-Speed” CAN in that the maximum baud rate is 125K and it utilizes CAN transceivers that offer fault-tolerant capability. This enables the CAN bus to keep operating even if one of the wires is cut or short-circuited because it operates on relative changes in voltage, and thus provides a much higher level of safety. The transceiver solves many common and frequent wiring problems such as poor connectors, and also overcomes short circuits of either transmission wire to ground or battery voltage, or the other transmission wire. The transceiver resolves the fault situation without involvement of external hardware or software. On the detection of a fault, the transceiver switches to a one wire transmission mode and automatically switches back to differential mode if the fault is removed.

Special resistors are added to the circuitry for the proper operation of the fault-tolerant transceiver. The values of the resistors depend on the number of nodes and the resistance values per node. For guidelines on selecting the resistor, refer to the [Low-Speed/Fault-Tolerant CAN Pinout Cable](#) section of Chapter 4, [Connectors and Cables](#).

Because the low-speed transceiver switches to a fault tolerant mode on fault detection and continues to maintain communications, NI-CAN provides a special attribute, `Log Comm Warnings`, which when set to true enables the reporting of such warnings in the Read queue of the Network Interface rather than in the status returned from a function call. The default value of this attribute is false, which enables the reporting of low-speed transceiver warnings in the status returned from a function call.



---

# Summary of the LIN Standard

This appendix provides a summary of the LIN standard.

## History and Use of LIN

---

LIN (Local Interconnect Network) was developed to create a standard for low-cost, low-end multiplexed communication in automotive networks. Whereas CAN addressed the need for high bandwidth, advanced error-handling networks, the hardware and software costs of CAN implementation became prohibitive for lower performance devices like power window and seat controllers. LIN provides cost efficient communication in applications where the bandwidth and versatility of CAN are not required. LIN can be implemented relatively inexpensively using the standard serial UART embedded into most modern low-cost 8-bit microcontrollers.

## LIN Frame Format

---

LIN is a polled bus with a single master device and one or more slave devices. The master device contains both a master task and a slave task. Each slave device contains only a slave task. Communication over the LIN is controlled entirely by the master task in the master device.

The basic unit of transfer on the LIN bus is the frame, which is divided into a header and a response. The header is always transmitted by the master node and consists of three distinct fields: the Break, the Synchronization Field (Sync), and Identifier Field (ID). The response is transmitted by a slave task (which can reside in either the master node or a slave node) and consists of a data payload and a checksum.

Normally, the master task polls each slave task in a loop by transmitting a header, which consists of a Break-Sync-ID sequence. Prior to starting the LIN, each slave task is configured to either publish data to the bus or subscribe to data in response to each received header ID. Upon receiving the header, each slave task verifies ID parity and then checks the ID to determine whether it needs to publish or subscribe. If the slave task needs to publish a response, it transmits 1–8 data bytes to the bus followed by a



checksum byte. If the slave task needs to subscribe, it reads the data payload and checksum byte from the bus and takes appropriate internal action. For standard slave-to-master communication, the master will broadcast the identifier to the network, and one and only one slave will respond with a data payload.

Master-to-slave communication is accomplished by a separate slave task which exists in the master node. This task self-receives all data published to the bus and responds as if it were an independent slave node. To transmit data bytes, the master must first update its internal slave task's response with the data values it wants to transmit. The master would then publish the appropriate frame header and the internal slave task would transmit its data payload to the bus.

## Break

Every LIN frame begins with the Break, comprised of 13 dominant bits (nominal) followed by a break delimiter of one bit (nominal) recessive. This serves as a start-of-frame notice to all nodes on the bus.

## Sync

The Sync field is the second field transmitted by the master task in the header. Sync is defined as the character x55. The Sync field allows slave devices that perform automatic baud rate detection to measure the period of the baud rate and adjust their internal baud rate to synchronize with the bus.

## ID

The ID field is the final field transmitted by the master task in the header. This field provides identification for each message on the network and ultimately determines which nodes in the network receive or respond to each transmission. All slave tasks continually listen for Identifier Fields, verify their parity and determine if they are publishers or subscribers for this particular identifier. LIN provides a total of 64 IDs. IDs 0–59 are used for signal-carrying (data) frames, 60–61 are used to carry diagnostic data, 62 is reserved for user-defined extensions, and 63 is reserved for future protocol enhancements. The ID is transmitted over the bus as one protected ID byte, with the lower 6 bits containing the raw ID and the upper two bits containing the parity.

Figure C-1 shows how parity is calculated using the raw ID, and how the protected ID is formed from the combination of the parity bits and raw ID.

Protected ID(7:6)		Protected ID(5:0)
P(1)	P(0)	ID(5:0)
$\neg (\text{ID}(1) \oplus \text{ID}(3) \oplus \text{ID}(4) \oplus \text{ID}(5))$	$\text{ID}(0) \oplus \text{ID}(1) \oplus \text{ID}(2) \oplus \text{ID}(4)$	0–63

**Figure C-1.** Parity Calculation Method

## Data Bytes

The Data Bytes field is transmitted by the slave task in the response. This field contains from 1 to 8 bytes of payload data bytes.

## Checksum

The Checksum field is transmitted by the slave task in the response. LIN defines the use of one of two checksum algorithms to calculate the value in the 8-bit checksum field. Classic checksum is calculated by summing the data bytes alone, while Enhanced checksum is calculated by summing the data bytes and the protected ID.

The LIN 2.0 specification defines the checksum calculation process as the summing of all values and subtraction of 255 every time the sum is greater than or equal to 256 (unlike modulo-255 or modulo-256). Per the LIN 2.0 specification, classic checksum is for use with LIN 1.3 slave nodes and enhanced checksum with LIN 2.0 slave nodes. It further specifies that IDs 60–63 shall always use classic checksum. The NI LIN interface provides an attribute to set the checksum type to classic or enhanced. The default setting is classic. Per the LIN 2.0 specification, IDs 60–63 always use classic checksum, regardless of the setting of the checksum attribute.

Figure C-2 illustrates how a master task header and a slave task response combine to create a LIN full frame.

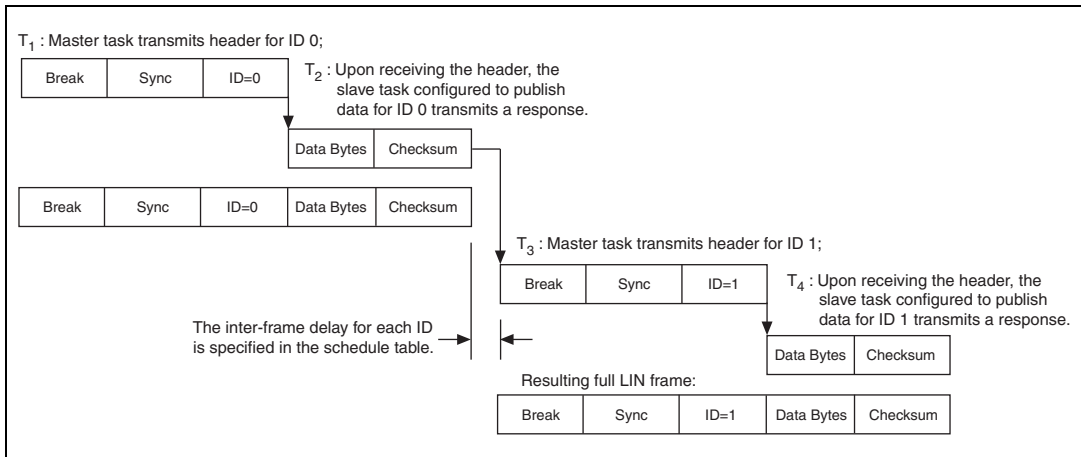

Figure C-2. Creation of LIN Full Frames

## LIN Bus Timing

As LIN is a polled bus, processing of each frame is allocated a nominal time slot as follows:

$$T_{\text{Header\_Nominal}} = 34 * T_{\text{Bit}}$$

$$T_{\text{Response\_Nominal}} = 10 * (N_{\text{Data}} + 1) * T_{\text{Bit}}$$

$$T_{\text{Frame\_Nominal}} = T_{\text{Header\_Nominal}} + T_{\text{Response\_Nominal}}$$

Processing of each frame is allocated a maximum time slot as follows:

$$T_{\text{Header\_Maximum}} = 14 * T_{\text{Header\_Nominal}}$$

$$T_{\text{Response\_Maximum}} = 1.4 * T_{\text{Response\_Nominal}}$$

$$T_{\text{Frame\_Maximum}} = T_{\text{Header\_Maximum}} + T_{\text{Response\_Maximum}}$$

# LIN Topology and Behavior

---

The LIN bus connects a single master device (node) and one or more slave devices (nodes) together in what is called a LIN cluster. The behavior of each node is described by its own node capability file. The node capability files are inputs to a *system defining tool*, which generates a LIN description file (LDF) that describes the behavior of the entire cluster. The LDF is parsed by a System Generator to automatically generate the specified behavior in the desired nodes. At this point, the master node master task starts transmitting headers on the bus, and all the slave tasks in the cluster (including the master node's own slave task) respond, as specified in the LDF.

In general terms, the LDF is used to configure and create the scheduling behavior of the LIN cluster. For example, it defines the baud rate, the ordering and time delays for the master task's transmission of headers, and the behavior of each slave task in response. The NI-CAN Frame API for LIN and NI LIN hardware do not natively provide full support for LDFs, meaning that scheduling behavior cannot be downloaded into the hardware. However, the low-level support of accessing the bus (writing headers and publishing or subscribing to responses) is provided such that the user may create this scheduling behavior at the application level. As mentioned in the description for the NI LIN response entry frame type, the NI LIN hardware does provide a response queue for storing slave task responses. The response queue holds 64 responses, one for each of the maximum number of 64 IDs specified for LIN. This ensures that the LIN interface slave task can respond to headers within the response time defined by the LIN specification.

The NI-CAN Frame API for LIN provides a robust means of complete, low-level interaction with the LIN bus. This provides the end user with the basic functionality from which to develop complex applications involving the analysis and prototyping of LIN networks. The NI-CAN Frame API for LIN does not natively support LIN diagnostics or configuration, LIN Description Files or schedule tables. However, these tasks may be implemented in applications making use of the NI-CAN Frame API for LIN.

## LIN Error Detection and Confinement

---

The LIN 2.0 specification specifies that error detection should be handled by the slave tasks and that monitoring of errors by the master task is not required. The LIN 2.0 specification does not require handling of multiple errors within one LIN frame or the use of error counters. Upon encountering the first error in a frame, the slave task aborts processing of the frame until the detection of the next Break-Sync sequence (in the next header transmitted by the master). If the log bus errors attribute is set true, a bus error frame is logged into the read queue. If the log bus errors attribute is set false, an error is returned by `ncWriteNet` or `ncWriteNetMult`.

LIN also provides for error reporting to the network. The LIN 2.0 specification defines a `Response_Error` status bit, which the slave is required to report to the master in one of its transmitted frames. This bit is set whenever a frame received or transmitted by a slave node contains an error in the response field. The bit is cleared after it is transmitted in one of the slaves published responses. The NI-CAN Frame API for LIN does not natively support the `Response_Error` status bit, but provides the end user with a means to easily implement this functionality at the application level. The procedure is to set the log bus errors attribute equal to one, to enable logging of bus error frames in the read queue. The application can then monitor for a read of a bus error frame with the error code indicating an error in the response. Upon this condition, the application can set a `Response_Error` status bit in a local variable. The application can then use the NI LIN response entry frame type to update the slave response queue with data containing the `Response_Error` status bit and then clear the bit in the local variable.

## LIN Sleep and Wakeup

---

LIN provides a mechanism for devices to enter sleep state and potentially conserve power. Per the LIN 2.0 specification, all slaves may be forced into sleep mode by the master sending a diagnostic master request frame (ID=60) with the first data byte equal to zero. This special frame is called the go-to-sleep command. Slaves shall also automatically enter sleep mode if the LIN is inactive for more than 4 seconds.

The NI-CAN Frame API for LIN provides great flexibility by allowing the user to put the LIN interface to sleep as desired at the application level. Upon receiving a full frame containing a sleep request message, or a bus inactive frame indicating 4 seconds of bus inactivity, the user may choose

to put the LIN interface to sleep by setting the **LIN Sleep** attribute to TRUE.

LIN also provides a mechanism for waking devices on the bus. Wakeup is one task that may be initiated by any node on the bus (a slave as well as the master). Per the LIN 2.0 specification, the wakeup request is issued by forcing the bus dominant for 250 microseconds to 5 milliseconds. Each slave should detect the wakeup request and be ready to process headers within 100 milliseconds. The master should also detect the wakeup request and start sending headers when the slave nodes are ready (within 100 to 150 milliseconds after receiving the wakeup request). If the master does not issue headers within 150 milliseconds after receiving the first wakeup request, then the slave requesting wakeup may try issuing a second wakeup request (and waiting for another 150 milliseconds). If the master still does not respond, the slave may issue the wakeup request and wait 150 milliseconds a third time. If there is still no response, the slave must wait for 1.5 seconds before issuing a fourth wakeup request. The NI-CAN Frame API for LIN allows wakeup to be performed according to the LIN 2.0 specification regardless of whether the LIN interface is operating as a master or slave.

## Advanced Frame Types

---

The LIN 2.0 specification further classifies LIN frames into six types (unconditional, event triggered, sporadic, diagnostic, user-defined, and reserved). It is important to note that the differences in these frame types are due to either the timing of how they are transmitted or the content of the data bytes. Regardless of frame classification, a full LIN frame always consists of a header transmitted by the master task and a response transmitted by a slave task. The NI-CAN Frame API for LIN can address the needs of handling each of these LIN-specified frame types.

The unconditional frame type is most commonly used. Unconditional frames carry signals (data) and their identifiers are in the range of 0–59. The event triggered frame type attempts to conserve bus bandwidth by requesting an unconditional frame response from multiple slaves within one frame slot time.

The event triggered frame may have an ID in the range of 0–59. Each slave that could potentially respond to the event triggered header ID has its first data byte loaded with the protected ID it would respond to if the master was querying it for an unconditional frame. The event triggered frame works as follows. The master writes an event triggered ID in a header. The slaves may only respond to the event triggered ID if their data has been updated.

If only one slave publishes a response, then the master receives it and looking at the first data byte, knows from which slave (through the protected ID), it was received. If multiple slaves publish a response then a collision will occur, which the master device slave task will report as a bus error. The master device will then query a response from each slave using unconditional frames.

Sporadic frames attempt to provide some dynamic behavior to the LIN. Sporadic frames always carry signals (data) and their IDs are in the range of 0–59. The header of a sporadic frame should only be sent in its frame slot when the master task knows that a data value (signal) within the frame has been updated. This requirement makes the master device slave task the normal publisher of sporadic frame responses.

Diagnostic frames are always eight data bytes in length, and always carry diagnostic or configuration data. Their ID is either 60 for a master request frame, or 61 for a slave response frame. User defined frames have an ID of 62 and may carry any type of information. Reserved frames have an ID of 63 and must not be used in a LIN 2.0 cluster.

## Additional LIN Information

---

For further details of the LIN specification, visit the LIN consortium website at [www.lin-subbus.org](http://www.lin-subbus.org).

## Frame Types for CAN and LIN Hardware

**Table D-1.** Frame Types for CAN Hardware

Value	Frame Type	ncReadNet	ncReadNetMult	ncWriteNet	ncWriteNetMult
0	CAN Data Frame	Series 1, Series 2, 847x, 847x with Sync	Series 1, Series 2, 847x, 847x with Sync	Series 1, Series 2, 847x, 847x with Sync	Series 1, Series 2, 847x, 847x with Sync
1	CAN Remote Frame	Series 2, 847x, 847x with Sync	Series 2, 847x, 847x with Sync	Series 1, Series 2, 847x, 847x with Sync	Series 1, Series 2, 847x, 847x with Sync
2	Comm Warning	Series 1, Series 2	Series 1, Series 2	—	—
3	RTSI Frame	Series 1, Series 2	Series 1, Series 2	—	—
4	Start Trigger Frame	Series 1, Series 2, 847x, 847x with Sync	Series 1, Series 2, 847x, 847x with Sync	—	Series 1, Series 2
5	Delay Frame	—	—	—	Series 1, Series 2
6	Bus Error Frame	Series 2, 847x, 847x with Sync	Series 2, 847x, 847x with Sync	—	—
7	Transceiver Faults	Series 1, Series 2, 847x, 847x with Sync	Series 1, Series 2, 847x, 847x with Sync	—	—

1—The hardware is listed by Series.



**Table D-2.** Frame Types for LIN Hardware

<b>Value</b>	<b>Frame Type</b>	<b>ncReadNet</b>	<b>ncReadNetMult</b>	<b>ncWriteNet</b>	<b>ncWriteNetMult</b>
4	Start Trigger Frame	847x, 847x with Sync (Master/Slave)	847x, 847x with Sync (Master/Slave)	—	—
16	LIN Response Entry Frame	—	—	847x, 847x with Sync (Slave)	847x, 847x with Sync (Slave)
17	LIN Header Frame	—	—	847x, 847x with Sync (Master)	847x, 847x with Sync (Master)
18	LIN Full Frame	847x, 847x with Sync (Slave)	847x, 847x with Sync (Slave)	847x, 847x with Sync (Master/Slave)	847x, 847x with Sync (Master/Slave)
19	LIN Wakeup Received Frame	847x, 847x with Sync (Master/Slave)	847x, 847x with Sync (Master/Slave)	—	—
20	LIN Bus Inactive Frame	847x, 847x with Sync (Slave)	847x, 847x with Sync (Slave)	—	—
21	LIN Bus Error Frame	847x, 847x with Sync (Master/Slave)	847x, 847x with Sync (Master/Slave)	—	—
1—The hardware is listed by Series.					
2—Master and Slave refer to the Master and Slave tasks of the hardware.					

---

# Specifications

This appendix describes the physical characteristics of the CAN hardware, along with the recommended operating conditions.

## PCI-CAN Series 2

---

This section lists specifications for PCI-CAN Series 2 hardware.

### Power Requirement

+5 VDC ( $\pm 5\%$ )	
PCI-CAN .....	800 mA typical
PCI-CAN/2 .....	850 mA typical
PCI-CAN/LS.....	800 mA typical
PCI-CAN/LS2.....	850 mA typical
PCI-CAN/SW .....	750 mA typical
PCI-CAN/SW2 .....	800 mA typical
PCI-CAN/XS .....	800 mA typical
PCI-CAN/XS2 .....	900 mA typical

### Physical

Dimensions.....	20.70 cm $\times$ 11.18 cm (8.150 in. $\times$ 4.4 in.)
I/O connector.....	9-pin male D-SUB for each port

### Operating Environment

Ambient temperature.....	0 to 55 °C
Relative humidity .....	10 to 90%, noncondensing

## Storage Environment

Ambient temperature .....-20 to 70 °C  
Relative humidity .....5 to 95%, noncondensing

## Optical Isolation

Isolation up to 60 V<sub>DC</sub> (continuous) channel-to-bus, port-to-port (two-port devices only).

This isolation is intended to prevent ground loops.

## RTSI

Trigger lines .....7 input/output  
Clock lines .....1 input/output  
I/O compatibility .....TTL  
Power-on state .....Input (High-Z)  
Response .....Rising Edge Triggers

## High-Speed CAN

Transceiver .....Philips TJA1041  
Max baud rate .....1 Mbps  
Min baud rate .....40 kbps  
CAN\_H, CAN\_L bus lines .....-27 to +40 VDC  
VBAT power requirement  
(jumper set to EXT) .....+8 to +27 VDC  
on V+ connector pin  
(referenced to V-)

## Low-Speed/Fault-Tolerant CAN

Transceiver .....Philips TJA1054A  
Max baud rate .....125 kbps

Min baud rate .....	5 kbps, 10 kbps min for all error modes
CAN_H, CAN_L bus lines .....	-27 to +40 VDC
VBAT power requirement (jumper set to EXT) .....	+8 to +27 VDC on V+ connector pin (referenced to V-)

## Single Wire CAN

Transceiver .....	Philips AU5790
Max baud rate .....	33.3 kbps (normal transmission mode), 83.3 kbps (High-Speed transmission mode)
Min baud rate .....	5 kbps, 10 kbps min for all error modes
CAH_H bus line .....	-10 to +18 VDC
VBAT power requirement (always required) .....	+8 to +18 VDC (12 VDC recommended) on V+ connector pin (referenced to V-)

## XS Software Selectable

Relay service life	
Mechanical .....	50,000,000 operations min. (at 36,000 operations per hour)
External mode digital I/O characteristics	
MODE0, MODE1—digital outputs	
STATUS—digital input	

Level	Min	Max
V <sub>IL</sub>	0.0 V	0.8 V
V <sub>IH</sub>	2.0 V (typ)	5.0 V

Level	Min	Max
$V_{OL}$ ( $I_{OL} = 32$ mA)	—	0.55 V
$V_{OH}$ ( $I_{OH} = -32$ mA)	3.8 V	—

## PXI-846x Series 2

This section lists specifications for PXI-846x Series 2 hardware.

### Power Requirement

+5 VDC ( $\pm 5\%$ )

PXI-8461 (1 port) .....	800 mA typical
PXI-8461 (2 ports).....	850 mA typical
PXI-8460 (1 port) .....	800 mA typical
PXI-8460 (2 ports).....	850 mA typical
PXI-8464 (1 port) .....	850 mA typical
PXI-8464 (2 ports).....	900 mA typical

### Physical

Dimensions ..... 16.0 cm  $\times$  10.0 cm  
(6.3 in.  $\times$  3.9 in.)

I/O connector ..... 9-pin male D-SUB for each port

### Operating Environment

Ambient temperature ..... 0 to 55 °C

Relative humidity ..... 10 to 90%, noncondensing

(Tested in accordance with IEC-60068-2-1, IEC-60068-2-2,  
IEC-60068-2-56.)

### Storage Environment

Ambient temperature ..... -20 to 70 °C

Relative humidity ..... 5 to 95%, noncondensing

(Tested in accordance with IEC-60068-2-1, IEC-60068-2-2,  
IEC-60068-2-56.)

## Functional Shock

30 g peak, half-sine, 11 ms pulse

(Tested in accordance with IEC-60068-2-27. Test profile developed in accordance with MIL-T-28800E.)

## Random Vibration

Operating..... 5 to 500 Hz, 0.3 grms

Nonoperating..... 5 to 500 Hz, 2.4 grms

(Tested in accordance with IEC-60068-2-64. Nonoperating test profile developed in accordance with MIL-T-28800E and MIL-STD-810E Method 514.)

## Optical Isolation

Isolation up to 60 V<sub>DC</sub> (continuous) channel-to-bus, port-to-port (two-port devices only).

This isolation is intended to prevent ground loops.

## PXI Trigger Bus

Trigger lines ..... 7 input/output

PXI\_Star trigger ..... 1 input

Clock lines..... 1 input/output

PXI\_Clk10 ..... 1 input

I/O compatibility ..... TTL

Power-on state..... Input (High-Z)

Response ..... Rising Edge Triggers

## High-Speed CAN

Transceiver..... Philips TJA1041

Max baud rate..... 1 Mbps

Min baud rate ..... 40 kbps

CAN_H, CAN_L bus lines .....	-27 to +40 VDC
VBAT power requirement (jumper set to EXT) .....	+8 to +27 VDC on V+ connector pin (referenced to V-)

## Low-Speed/Fault-Tolerant CAN

Transceiver .....	Philips TJA1054A
Max baud rate .....	125 kbps
Min baud rate .....	5 kbps, 10 kbps min for all error modes
CAN_H, CAN_L bus lines .....	-27 to +40 VDC
VBAT power requirement (jumper set to EXT) .....	+8 to +27 VDC on V+ connector pin (referenced to V-)

## Single Wire CAN

Transceiver .....	Philips AU5790
Max baud rate .....	33.3 kbps (normal transmission mode), 83.3 kbps (High-Speed transmission mode)
Min baud rate .....	5 kbps, 10 kbps min for all error modes
CAH_H bus line .....	-10 to +18 VDC
VBAT power requirement (always required) .....	+8 to +18 VDC (12 VDC typical) on V+ connector pin (referenced to V-)

## XS Software Selectable

Relay service life

Mechanical..... 50,000,000 operations min.  
(at 36,000 operations per hour)

External mode digital I/O characteristics

MODE0, MODE1—digital outputs

STATUS—digital input

Level	Min	Max
$V_{IL}$	0.0 V	0.8 V
$V_{IH}$	2.0 V (typ)	5.0 V
$V_{OL}$ ( $I_{OL} = 32$ mA)	—	0.55 V
$V_{OH}$ ( $I_{OH} = -32$ mA)	3.8 V	—

## PCMCIA-CAN Series 2

This section lists specifications for PCMCIA-CAN Series 2 hardware.

### Power Requirement

+5 VDC ( $\pm 5\%$ )

PCMCIA-CAN ..... 350 mA typical; active

1-port PCMCIA-CAN

internal power cable..... +55 mA typical

PCMCIA-CAN/2 ..... 350 mA typical; active

2-port PCMCIA-CAN

internal power cable..... +115 mA typical

### Physical

Dimensions..... 8.56 cm  $\times$  5.40 cm  $\times$  0.5 cm  
(3.4 in.  $\times$  2.1 in.  $\times$  0.2 in.)

I/O connector..... PCMCIA-CAN cable with 9-pin  
male D-SUB and pluggable screw  
terminal for each port



## Operating Environment

Ambient temperature .....0 to 55 °C

Relative humidity ..... 10 to 90%, noncondensing

(Tested in accordance with IEC-60068-2-1, IEC-60068-2-2, EC-60068-2-56.)

## Storage Environment

Ambient temperature .....-20 to 70 °C

Relative humidity .....5 to 95%, noncondensing

(Tested in accordance with IEC-60068-2-1, IEC-60068-2-2, EC-60068-2-56.)

## Optical Isolation

Isolation up to 60 V<sub>DC</sub> (continuous) channel-to-bus, port-to-port (two-port devices only) in PCMCIA-CAN cables.

This isolation is intended to prevent ground loops.

## Synchronization Triggers

Trigger lines.....4 input/output (TRIG\_0-TRIG\_3)

Clock lines ..... 1 input (TRIG7\_CLK)

I/O compatibility.....TTL

Power-on state .....Input (High-Z)

Response .....Rising Edge Triggers

Level	Min	Max
V <sub>IL</sub>	-0.5 V	0.8 V
V <sub>IH</sub>	1.7 V	5.75 V
V <sub>OL</sub> (I <sub>OL</sub> = 8 mA)	—	0.45 V
V <sub>OH</sub> (I <sub>OH</sub> = 8 mA)	2.4 V	—

## High-Speed Transceiver Cable

Transceiver.....	Philips TJA1041
Max baud rate.....	1 Mbps
Min baud rate .....	40 kbps
CAN_H, CAN_L bus lines .....	-27 to +40 VDC
Power requirements.....	Internally powered

## Low-Speed/Fault-Tolerant Transceiver Cable

Transceiver.....	Philips TJA1054A
Max baud rate.....	125 kbps
Min baud rate .....	5 kbps, 10 kbps min for all error modes
CAN_H, CAN_L bus lines .....	-27 to +40 VDC
Power requirements.....	Internally powered

## Single-Wire Cable

Transceiver.....	Philips AU5790
Max baud rate.....	33.3 Kbps (normal transmission mode), 83.3 Kbps (High-Speed transmission mode)
Min baud rate .....	5 kbps, 10 kbps min for all error modes
CAN_H bus line.....	-10 to +18 VDC
Power requirement (always required).....	+8 to +18 VDC (12 VDC recommended) on V+ connector pin (referenced to V-)

# USB-CAN and USB-LIN

---

This section lists specifications for USB-CAN and USB-LIN hardware.

## Power Requirement

+5 VDC ( $\pm 5\%$ )

USB-CAN.....250 mA typical

USB-LIN .....200 mA typical

## Physical

Dimensions

Non-Sync .....7.87 cm  $\times$  6.35 cm  $\times$  2.54 cm  
(3.1 in.  $\times$  2.5 in.  $\times$  1.0 in.)

Sync .....7.87 cm  $\times$  7.11 cm  $\times$  2.54 cm  
(3.1 in.  $\times$  2.8 in.  $\times$  1.0 in.)

Cable length .....2 m

I/O connector .....9-pin male D-SUB,  
Optional 3-pin Combicon  
for synchronization

## Operating Environment

Ambient temperature .....0 to 55 °C

Relative humidity .....10 to 90%, noncondensing

(Tested in accordance with IEC-60068-2-1, IEC-60068-2-2,  
IEC-60068-2-56.)

## Storage Environment

Ambient temperature .....-20 to 70 °C

Relative humidity .....5 to 95%, noncondensing

(Tested in accordance with IEC-60068-2-1, IEC-60068-2-2,  
IEC-60068-2-56.)

## Optical Isolation

Isolation up to 500 V<sub>DC</sub> (withstand, 2 s max) channel-to-bus, port-to-port (two-port devices only)

## Synchronization Triggers (USB-8472s, USB-8473s, and USB-8476s only)

Trigger lines .....	1 input/output
Clock lines.....	1 input/output
Input clock tolerance	
1 MHz .....	Frequency: $\pm 1\%$ Duty Cycle: 25% to 75%
10 MHz .....	Frequency: $\pm 1\%$ Duty Cycle: 25% to 75%
20 MHz .....	Frequency: $\pm 1\%$ Duty Cycle: 40% to 53%
I/O compatibility .....	TTL
Power-on state .....	Input (High-Z)
Response .....	Rising Edge Triggers

## High-Speed CAN

Transceiver .....	Philips TJA1041
Max baud rate.....	1 Mbps
Min baud rate .....	40 kbps
CAN_H, CAN_L bus lines .....	-27 to +40 VDC

## Low-Speed/Fault-Tolerant CAN

Transceiver .....	Philips TJA1054A
Max baud rate.....	125 kbps
Min baud rate .....	5 kbps, 10 kbps min for all error modes
CAN_H, CAN_L bus lines .....	-27 to +40 VDC

## LIN

Transceiver .....	AMTEL ATA6625
Max baud rate .....	20 kbps
Min baud rate .....	2.4 kbps
VBAT power requirement	
(always required) .....	+5 to +27 VDC (ATA6625), +8 to +18 VDC (ATA6620) (12 VDC typical) on V+ connector pin (referenced to V-)

## Safety

This product is designed to meet the requirements of the following standards of safety for electrical equipment for measurement, control, and laboratory use:

- IEC 60950-1, EN 60950-1
- UL 60950-1, CSA 60950-1



**Note** For UL and other safety certifications, refer to the product label or the [Online Product Certification](#) section.

Pollution Degree.....2

Maximum altitude.....2,000 m

Indoor use only.

## Electromagnetic Compatibility

This product meets the requirements of the following EMC standards for electrical equipment for measurement, control, and laboratory use:

- EN 61326-1 (IEC 61326-1): Class A emissions; Basic immunity
- EN 55011 (CISPR 11): Group 1, Class A emissions
- AS/NZS CISPR 11: Group 1, Class A emissions
- FCC 47 CFR Part 15B: Class A emissions
- ICES-001: Class A emissions



**Caution** When operating this product, use shielded cables and accessories.

**Note** For EMC declarations and certifications, refer to the [Online Product Certification](#) section.

## CE Compliance

This product meets the essential requirements of applicable European Directives as follows:

- 2006/95/EC; Low-Voltage Directive (safety)
- 2004/108/EC; Electromagnetic Compatibility Directive (EMC)

## Online Product Certification

To obtain product certifications and the DoC for this product, visit [ni.com/certification](http://ni.com/certification), search by model number or product line, and click the appropriate link in the Certification column.

## Environmental Management

NI is committed to designing and manufacturing products in an environmentally responsible manner. NI recognizes that eliminating certain hazardous substances from our products is beneficial to the environment and to NI customers.

For additional environmental information, refer to the *Minimize Our Environmental Impact* web page at [ni.com/environment](http://ni.com/environment). This page contains the environmental regulations and directives with which NI complies, as well as other environmental information not included in this document.

## Waste Electrical and Electronic Equipment (WEEE)



**EU Customers** At the end of the product life cycle, all products *must* be sent to a WEEE recycling center. For more information about WEEE recycling centers, National Instruments WEEE initiatives, and compliance with WEEE Directive 2002/96/EC on Waste and Electronic Equipment, visit [ni.com/environment/weee](http://ni.com/environment/weee).

## 电子信息产品污染控制管理办法（中国 RoHS）



**中国客户** National Instruments 符合中国电子信息产品中限制使用某些有害物质指令 (RoHS)。关于 National Instruments 中国 RoHS 合规性信息，请登录 [ni.com/environment/rohs\\_china](http://ni.com/environment/rohs_china)。(For information about China RoHS compliance, go to [ni.com/environment/rohs\\_china](http://ni.com/environment/rohs_china).)

---

# NI-XNET Compatibility for NI-CAN

## Overview and Purpose

---

NI-XNET is the new series of National Instruments CAN/LIN and FlexRay-capable hardware, with significantly increased performance and additional capabilities over the previous NI-CAN hardware. The new hardware includes a new NI-XNET API that can use the new features directly. As a result, a native NI-XNET application provides optimal performance and can be significantly faster than the same application on Series 2. This also means that existing software that uses the NI-CAN APIs is not compatible with the new NI-XNET API.

The NI-XNET Compatibility Library for NI-CAN is a software layer added as part of NI-XNET. This software layer enables code that uses Frame or Channel APIs to work with NI-XNET CAN (not LIN or FlexRay) PCI and PXI and NI-XNET CAN and LIN USB hardware, where compatibility between the older APIs and the new driver and hardware is possible. As a result, you can use the new NI-XNET hardware under the more limited capabilities of the previous APIs, while you can develop NI-XNET native versions to take advantage of greater native performance. Even without native NI-XNET code, the side-by-side performance of the same NI-CAN code using NI-XNET hardware under compatibility can provide an upgrade over older hardware.

## Installation and Configuration

---

To use NI-XNET devices as NI-CAN-compatible devices, install NI-CAN 2.7 or higher and NI-XNET 1.0 or higher with the NI-XNET Compatibility Library for NI-CAN feature enabled. The NI-XNET Compatibility Library for NI-CAN feature is part of NI-XNET, and you can install it as an option during NI-XNET installation. The NI-XNET Compatibility Library for NI-CAN is supported for the set of operating systems that both NI-CAN and NI-XNET support. You can install and use both NI-CAN and NI-XNET independently.

When NI-CAN and NI-XNET with the NI-XNET Compatibility Library for NI-CAN are installed, some additional features are available to configure and use NI-XNET hardware under NI-CAN. In particular, new NI-CAN-style devices appear for each compatible NI-XNET device in Measurement & Automation Explorer (MAX).

## Measurement & Automation Explorer (MAX)

NI-CAN hardware displays in MAX under **Devices and Interfaces**. For example, the Series 2 CAN hardware appears as PCI-CAN or PXI-CAN devices. However, NI-XNET devices for use with its native API appear under the **NI-XNET Devices** folder. Selecting an NI-XNET interface in that location displays various statistics and options, including serial numbers and assigned interface numbers to its port(s). This information is similar to that visible for an NI-CAN device.

When the NI-XNET Compatibility Library for NI-CAN is installed, NI-XNET hardware also appears as NI PCI or PXI-815x devices (their board series number) under **Devices and Interfaces** along with actual NI-CAN devices. These device entries are effectively NI-CAN devices usable only in NI-CAN through the new compatibility functionality, actually referring to corresponding NI-XNET devices.

Selecting these compatibility devices shows the standard set of information about the device; notice that their series is reported as “NI-XNET” to identify them properly. The compatibility device serial number uniquely relates it to the corresponding NI-XNET device. The compatibility devices also have the familiar child entries for their various ports; baud rate and various configuration options are accessible here, just as with the native NI-CAN hardware devices.

One of the visible differences between NI-XNET and NI-CAN is that NI-CAN interface names start at *CAN0* while NI-XNET interface names start at *CAN1*.

As the MAX information indicates, you can identify in the API whether a device is actually an NI-XNET device by querying its series. A compatibility device returns its series as NI-XNET.



## Limitations

---

NI-XNET devices used under compatibility through NI-CAN are accessed through the same NI-CAN APIs as native NI-CAN devices. These compatibility devices are not visible or usable through their native NI-XNET API. This means that the device with a CAN<sub>x</sub> port name has a different meaning depending on whether this port is under the NI-CAN or NI-XNET API; each numbering scheme is independent. As a result, you can have an NI-CAN port CAN1 and NI-XNET port CAN1 at the same time without referring to the same hardware.

You also should do configuration in MAX on the appropriate node. For example, baud rates are not configurable for NI-XNET device entries in MAX; to configure the hardware for compatibility, modify this setting in the compatibility entry for that device, which has the appropriate interface to match the NI-CAN functionality.

Due to the differences between NI-CAN and NI-XNET, the NI-XNET Compatibility Library for NI-CAN does not provide 100 percent compatibility coverage. The tables in Broken Compatibility list specific limitations for each NI-CAN API. For code that cannot work with compatibility devices, or for developers wanting to take full advantage of the better performance, ease of use, protocols, or other benefits of native NI-XNET API, a set of guidelines for porting NI-CAN code to NI-XNET are available as KnowledgeBase articles.

## Broken Compatibility

---

While the NI-XNET Compatibility Library for NI-CAN is designed to ensure basic functionality, it cannot always be completely mapped from NI-CAN to NI-XNET due to hardware-specific features, pending functionality from NI-XNET, or flaws in the original design of NI-CAN. The following tables describe the differences between the available attributes/functions/virtual instruments in NI-CAN and the NI-XNET Compatibility Library for NI-CAN.

## Reading the Tables

The table features can be two types of broken compatibility: missing features or compatibility errors.

A missing feature means the feature may be available in a later release of NI-XNET, but not at the time of this writing. In many of these cases, the feature will be added to the NI-XNET Compatibility Library for NI-CAN when it becomes available in NI-XNET. However, this is not always a guarantee of future availability; contact National Instruments if you rely on one of these features and require the functionality.

If a feature is marked as a compatibility error, there currently is no appropriate functionality in NI-XNET, usually due to hardware-specific features or error-prone design flaws in the original NI-CAN. Contact National Instruments if a feature marked as a compatibility error is required for your application, and no suitable workaround exists.

## Channel API for LabVIEW

Feature	Specific Feature	Reason
CAN Initialize.vi, CAN Init Start.vi	Loading from multiple databases	Compatibility error
CAN Initialize.vi, CAN Init Start.vi	Output with > 1 multiplexer values	Compatibility error
CAN Get Property.vi	Behavior after final output	Missing feature
CAN Get Property.vi	Interface transceiver external outputs	Missing feature
CAN Get Property.vi	Interface transceiver external inputs	Missing feature
CAN Get Property.vi	Message multiple frame distribution	Compatibility error
CAN Get Property.vi	Interface Series 2 error/arb capture	Compatibility error
CAN Get Property.vi	Hardware master timebase rate	Compatibility error
CAN Get Property.vi	Hardware timestamp format	Compatibility error
CAN Set Property.vi	Behavior after final output	Missing feature
CAN Set Property.vi	Interface Series 2 comparator	Compatibility error
CAN Set Property.vi	Interface Series 2 mask	Compatibility error
CAN Set Property.vi	Interface Series 2 filter mode	Compatibility error

Feature	Specific Feature	Reason
CAN Set Property.vi	Interface transceiver external outputs	Missing feature
CAN Set Property.vi	Interface transceiver external inputs	Missing feature
CAN Set Property.vi	Message multiple frame distribution	Compatibility error
CAN Set Property.vi	Interface Series 2 error/arb capture	Compatibility error
CAN Set Property.vi	Hardware master timebase rate	Compatibility error
CAN Set Property.vi	Hardware timestamp format	Compatibility error
CAN Set Property.vi	Channel default value	Compatibility error
CAN Connect Terminals.vi	Source terminal: interface receive event	Missing feature
CAN Connect Terminals.vi	Source terminal: interface transceiver event, 20 MHz timebase, 10 Hz resync clock	Compatibility error
CAN Connect Terminals.vi	Destination terminal: 10 Hz resync clock	Compatibility error
CAN Disconnect Terminals.vi	Source terminal: interface receive event	Missing feature
CAN Disconnect Terminals.vi	Source terminal: interface transceiver event, 20 MHz timebase, 10 Hz resync clock	Compatibility error
CAN Disconnect Terminals.vi	Destination terminal: 10 Hz resync clock	Compatibility error
nctRead	When using a task configured for timestamped input, the VI or function always waits for the full timeout duration	Missing feature

## Frame API for LabVIEW

Feature	Specific Feature	Reason
ncConfigCANObj.vi, ncConfigCANObjRTSI.vi	Communication type: transmit periodic waveform	Compatibility error
ncConfigCANObj.vi, ncConfigCANObjRTSI.vi	Receive changes only: TRUE	Compatibility error

Feature	Specific Feature	Reason
ncConfigCANObj.vi, ncConfigCANObjRTSI.vi	Transmit by response: TRUE	Compatibility error
ncConfigCANObjRTSI.vi	RTSI mode: on RTSI input—transmit CAN frame, on RTSI input—timestamp RTSI event, RTSI output on receiving CAN frame, RTSI output on transmitting CAN frame, RTSI output on ncAction call	Missing feature
ncConfigCANObjRTSI.vi	RTSI signal	Missing feature
ncConfigCANObjRTSI.vi	RTSI behavior	Missing feature
ncConfigCANObjRTSI.vi	RTSI skip	Missing feature
ncConfigCANObjRTSI.vi	User RTSI frame	Compatibility error
ncGetAttr.vi	Object state: 00000040 hex remote wakeup	Compatibility error
ncGetAttr.vi	Master timebase rate	Missing feature
ncGetAttr.vi	Log comm warnings	Compatibility error
ncGetAttr.vi	Log bus errors?	Missing feature
ncGetAttr.vi	Log start trigger?	Missing feature
ncGetAttr.vi	Start trigger behavior	Missing feature
ncGetAttr.vi	Transceiver external outputs	Missing feature
ncGetAttr.vi	Transceiver external inputs	Missing feature
ncGetAttr.vi	Series 2 error/arb capture	Compatibility error
ncSetAttr.vi	Timestamp format: (1) relative	Compatibility error
ncSetAttr.vi	Log comm warnings	Compatibility error
ncSetAttr.vi	Log bus error?	Missing feature
ncSetAttr.vi	Log transceiver fault?	Missing feature
ncSetAttr.vi	Transceiver external outputs	Missing feature
ncWaitForState.vi	00000040 hex remote wakeup	Missing feature
ncReadNet.vi, ncReadNetMult.vi	IsRemote: communication warning or error frame, start trigger frame	Missing feature

Feature	Specific Feature	Reason
ncReadNet.vi, ncReadNetMult.vi	IsRemote: RTSI frame, CAN bus error frame, transceiver fault frame	Compatibility error
ncAction.vi	Output on RTSI line	Compatibility error
ncConnectTerminals.vi	Source terminal: interface receive event	Missing feature
ncConnectTerminals.vi	Source terminal: interface transceiver event, 20 MHz timebase, 10 Hz resync clock	Compatibility error
ncConnectTerminals.vi	Destination terminal: 10 Hz resync clock	Compatibility error
ncDisconnectTerminals.vi	Source terminal: interface receive event	Missing feature
ncDisconnectTerminals.vi	Source terminal: interface transceiver event, 20 MHz timebase, 10 Hz resync clock	Compatibility error
ncDisconnectTerminals.vi	Destination terminal: 10 Hz resync clock	Compatibility error

## Channel API for C

Feature	Specific Feature	Reason
nctInitialize	Loading from multiple databases	Compatibility error
nctInitialize	Output with > 1 multiplexer values	Compatibility error
nctGetProperty	nctPropBehavAfterFinalOut	Missing feature
nctGetProperty	nctPropIntfTransceiverExternalOut	Missing feature
nctGetProperty	nctPropIntfTransceiverExternalIn	Missing feature
nctGetProperty	nctPropMsgDistribution	Compatibility error
nctGetProperty	nctPropIntfSeries2ErrArbCapture	Compatibility error
nctGetProperty	nctPropHwMasterTimebaseRate	Compatibility error
nctGetProperty	nctPropHwTimestampFormat	Compatibility error
nctSetProperty	nctPropBehavAfterFinalOut	Missing feature
nctSetProperty	nctPropIntfSeries2Comp	Compatibility error
nctSetProperty	nctPropIntfSeries2Mask	Compatibility error

<b>Feature</b>	<b>Specific Feature</b>	<b>Reason</b>
nctSetProperty	nctPropIntfSeries2FilterMode	Compatibility error
nctSetProperty	nctPropIntfTransceiverExternalOut	Missing feature
nctSetProperty	nctPropIntfTransceiverExternalIn	Missing feature
nctSetProperty	nctPropMsgDistribution	Compatibility error
nctSetProperty	nctPropIntfSeries2ErrArbCapture	Compatibility error
nctSetProperty	nctPropHwMasterTimebaseRate	Compatibility error
nctSetProperty	nctPropHwTimestampFormat	Compatibility error
nctSetProperty	nctPropChanDefaultValue	Compatibility error
nctConnectTerminals	nctSrcTermIntfReceiveEvent	Missing feature
nctConnectTerminals	nctSrcTermIntfTransceiverEvent	Compatibility error
nctConnectTerminals	nctSrcTerm20MHzTimebase	Compatibility error
nctConnectTerminals	nctSrcTerm10HzResyncClock	Compatibility error
nctConnectTerminals	nctDestTerm10HzResyncClock	Compatibility error
nctDisconnectTerminals	nctSrcTermIntfReceiveEvent	Missing feature
nctDisconnectTerminals	nctSrcTermIntfTransceiverEvent	Compatibility error
nctDisconnectTerminals	nctSrcTerm20MHzTimebase	Compatibility error
nctDisconnectTerminals	nctSrcTerm10HzResyncClock	Compatibility error
nctDisconnectTerminals	nctDestTerm10HzResyncClock	Compatibility error
nctRead	When using a task configured for timestamped input, the VI or function always waits for the full timeout duration	Missing feature

## Frame API for C

Feature	Specific Feature	Reason
ncConfig (CAN object)	NC_ATTR_COMM_TYPE: NC_CAN_COMM_TX_WAVEFORM	Compatibility error
ncConfig (CAN object)	NC_ATTR_RX_CHANGES_ONLY: NC_TRUE	Compatibility error
ncConfig (CAN object)	NC_ATTR_TX_RESPONSE: NC_TRUE	Compatibility error
ncConfig (network interface object)	NC_ATTR_LOG_START_TRIGGER	Missing feature
ncConfig (network interface object)	NC_ATTR_BEHAV_FINAL_OUT	Missing feature
ncConfig (network interface object)	NC_ATTR_TRANSCEIVER_TYPE: NC_TRANSCEIVER_TYPE_EXT, NC_TRANSCEIVER_TYPE_DISC	Missing feature
ncConfig (network interface object)	NC_ATTR_MASTER_TIMEBASE_RATE	Compatibility error
ncConfig (network interface object)	NC_ATTR_TIMELINE_RECOVERY	Compatibility error
ncConfig (network interface object)	NC_ATTR_RTSI_MODE	Missing feature
ncConfig (network interface object)	NC_ATTR_RTSI_SIGNAL	Missing feature
ncConfig (network interface object)	NC_ATTR_RTSI_SIG_BEHAV	Missing feature
ncConfig (network interface object)	NC_ATTR_RTSI_SKIP	Missing feature
ncConfig (network interface object)	NC_ATTR_RTSI_FRAME	Compatibility error
ncGetAttribute	NC_ATTR_STATE: NC_ST_REMOTE_WAKEUP	Compatibility error
ncGetAttribute (network interface object)	NC_ATTR_MASTER_TIMEBASE_RATE	Missing feature

<b>Feature</b>	<b>Specific Feature</b>	<b>Reason</b>
ncGetAttribute (network interface object)	NC_ATTR_SERIES2_MASK	Compatibility error
ncGetAttribute (network interface object)	NC_ATTR_LOG_COMM_ERRS	Compatibility error
ncGetAttribute (network interface object)	NC_ATTR_LOG_BUS_ERROR	Missing feature
ncGetAttribute (network interface object)	NC_ATTR_LOG_TRANSCEIVER_FAULT	Missing feature
ncGetAttribute (network interface object)	NC_ATTR_LOG_START_TRIGGER	Missing feature
ncGetAttribute (network interface object)	NC_ATTR_BEHAV_FINAL_OUT	Missing feature
ncGetAttribute (network interface object)	NC_ATTR_START_TRIG_BEHAVIOR	Missing feature
ncGetAttribute (network interface object)	NC_ATTR_TRANSCEIVER_EXTERNAL_OUT	Missing feature
ncGetAttribute (network interface object)	NC_ATTR_TRANSCEIVER_EXTERNAL_IN	Missing feature
ncGetAttribute (network interface object)	NC_ATTR_SERIES2_ERR_ARB_CAPTURE	Compatibility error
ncSetAttribute	NC_ATTR_START_TRIG_BEHAVIOR	Missing feature
ncSetAttribute (network interface object)	NC_ATTR_LOG_COMM_ERRS	Compatibility error
ncSetAttribute (network interface object)	NC_ATTR_LOG_BUS_ERROR	Missing feature
ncSetAttribute (network interface object)	NC_ATTR_LOG_TRANSCEIVER_FAULT	Missing feature
ncSetAttribute (network interface object)	NC_ATTR_TRANSCEIVER_EXTERNAL_OUT	Missing feature
ncSetAttribute (network interface object)	NC_ATTR_ABS_TIME	Compatibility error



Feature	Specific Feature	Reason
ncSetAttribute (network interface object)	NC_ATTR_RX_Q_LEN	Compatibility error
ncWaitForState	NC_ST_REMOTE_WAKEUP	Missing feature
ncWrite (network interface object)	NCTYPE_CAN_FRAME.IsRemote: NC_FRMTYPE_RTSM, NC_FRMTYPE_DELAY	Compatibility error
ncRead, ncReadMult (network interface object)	NCTYPE_CAN_FRAME.IsRemote: NC_FRMTYPE_COMM_ERR, NC_FRMTYPE_TRIG_START	Missing feature
ncRead, ncReadMult (network interface object)	NCTYPE_CAN_FRAME.IsRemote: NC_FRMTYPE_RTSM, NC_FRMTYPE_BUS_ERR, NC_FRMTYPE_TRANSCEIVER_ERR	Compatibility error
ncAction	NC_OP_RTSM_OUT	Compatibility error
ncConnectTerminals	NC_SRC_TERM_INTF_RECEIVE_EVENT	Missing feature
ncConnectTerminals	NC_SRC_TERM_INTF_TRANSCEIVER_EVENT	Compatibility error
ncConnectTerminals	NC_SRC_TERM_20MHZ_TIMEBASE	Compatibility error
ncConnectTerminals	NC_SRC_TERM_10HZ_RESYNC_CLOCK	Compatibility error
ncConnectTerminals	NC_DEST_TERM_10HZ_RESYNC_CLOCK	Compatibility error
ncDisconnectTerminals	NC_SRC_TERM_INTF_RECEIVE_EVENT	Missing feature
ncDisconnectTerminals	NC_SRC_TERM_INTF_TRANSCEIVER_EVENT	Compatibility error
ncDisconnectTerminals	NC_SRC_TERM_20MHZ_TIMEBASE	Compatibility error
ncDisconnectTerminals	NC_SRC_TERM_10HZ_RESYNC_CLOCK	Compatibility error
ncDisconnectTerminals	NC_DEST_TERM_10HZ_RESYNC_CLOCK	Compatibility error



---

# NI Services

National Instruments provides global services and support as part of our commitment to your success. Take advantage of product services in addition to training and certification programs that meet your needs during each phase of the application life cycle; from planning and development through deployment and ongoing maintenance.

To get started, register your product at [ni.com/myproducts](https://ni.com/myproducts).

As a registered NI product user, you are entitled to the following benefits:

- Access to applicable product services.
- Easier product management with an online account.
- Receive critical part notifications, software updates, and service expirations.

Log in to your National Instruments [ni.com](https://ni.com) User Profile to get personalized access to your services.

---

## Services and Resources

- **Maintenance and Hardware Services**—NI helps you identify your systems' accuracy and reliability requirements and provides warranty, sparing, and calibration services to help you maintain accuracy and minimize downtime over the life of your system. Visit [ni.com/services](https://ni.com/services) for more information.
  - **Warranty and Repair**—All NI hardware features a one-year standard warranty that is extendable up to five years. NI offers repair services performed in a timely manner by highly trained factory technicians using only original parts at a National Instruments service center.
  - **Calibration**—Through regular calibration, you can quantify and improve the measurement performance of an instrument. NI provides state-of-the-art calibration services. If your product supports calibration, you can obtain the calibration certificate for your product at [ni.com/calibration](https://ni.com/calibration).

- **System Integration**—If you have time constraints, limited in-house technical resources, or other project challenges, National Instruments Alliance Partner members can help. To learn more, call your local NI office or visit [ni.com/alliance](http://ni.com/alliance).
- **Training and Certification**—The NI training and certification program is the most effective way to increase application development proficiency and productivity. Visit [ni.com/training](http://ni.com/training) for more information.
  - The Skills Guide assists you in identifying the proficiency requirements of your current application and gives you options for obtaining those skills consistent with your time and budget constraints and personal learning preferences. Visit [ni.com/skills-guide](http://ni.com/skills-guide) to see these custom paths.
  - NI offers courses in several languages and formats including instructor-led classes at facilities worldwide, courses on-site at your facility, and online courses to serve your individual needs.
- **Technical Support**—Support at [ni.com/support](http://ni.com/support) includes the following resources:
  - **Self-Help Technical Resources**—Visit [ni.com/support](http://ni.com/support) for software drivers and updates, a searchable KnowledgeBase, product manuals, step-by-step troubleshooting wizards, thousands of example programs, tutorials, application notes, instrument drivers, and so on. Registered users also receive access to the NI Discussion Forums at [ni.com/forums](http://ni.com/forums). NI Applications Engineers make sure every question submitted online receives an answer.
  - **Software Support Service Membership**—The Standard Service Program (SSP) is a renewable one-year subscription included with almost every NI software product, including NI Developer Suite. This program entitles members to direct access to NI Applications Engineers through phone and email for one-to-one technical support, as well as exclusive access to online training modules at [ni.com/self-paced-training](http://ni.com/self-paced-training). NI also offers flexible extended contract options that guarantee your SSP benefits are available without interruption for as long as you need them. Visit [ni.com/ssp](http://ni.com/ssp) for more information.
- **Declaration of Conformity (DoC)**—A DoC is our claim of compliance with the Council of the European Communities using the manufacturer’s declaration of conformity. This system affords the user protection for electromagnetic compatibility (EMC) and product

safety. You can obtain the DoC for your product by visiting [ni.com/certification](http://ni.com/certification).

For information about other technical support options in your area, visit [ni.com/services](http://ni.com/services), or contact your local office at [ni.com/contact](http://ni.com/contact).

You also can visit the Worldwide Offices section of [ni.com/niglobal](http://ni.com/niglobal) to access the branch office websites, which provide up-to-date contact information, support phone numbers, email addresses, and current events.

# Glossary

---

Symbol	Prefix	Value
m	milli	$10^{-3}$
k	kilo	$10^3$
M	mega	$10^6$

## A

action *See* [method](#).

actuator A device that uses electrical, mechanical, or other signals to change the value of an external, real-world variable. In the context of device networks, actuators are devices that receive their primary data value from over the network; examples include valves and motor starters. Also known as final control element.

Application Programming Interface (API) A collection of functions used by a user application to access hardware. Within NI-CAN, you use API functions to make calls into the NI-CAN driver. NI-CAN provides two different APIs: the Frame API and Channel API.

arbitration ID An 11- or 29-bit ID transmitted as the first field of a CAN frame. The arbitration ID determines the priority of the frame, and is normally used to identify the data transmitted in the frame.

attribute The Frame API provides attributes to access configuration settings or other information. In the Channel API, the term property is used for similar settings.

## B

b Bits.

Behavior After Final Output Property in the Channel API that specifies the behavior to perform after the final periodic output sample is transmitted. For more information, refer to CAN Set Property.vi for LabVIEW, or nctSetProperty for C.

**bus off** A CAN node goes into the bus off state when its transmit error counter increments above 255. The node does not participate in network traffic, because it assumes that a defect exists that must be corrected.

## C

**CAN** Controller Area Network.

**CAN/LS** See [Low-speed CAN](#).

**CAN Channels** See [channel](#).

**CAN controller** Communications ship used to transmit and receive frames on a CAN network. The majority of the CAN specification is implemented within the CAN controller. Examples of CAN controllers include the Intel 82527 (used by Series 1 NI CAN hardware), and the Philips SJA1000 (used by Series 2 NI CAN hardware).

**CANdb** CAN database format defined by Vector Informatik. CANdb files use the .dbc file extension.

**CAN database** Database file that describes channels and associated messages for a collection of CAN nodes. NI-CAN supports two CAN database formats: CANdb, and the NI-CAN database.

**CAN data frame** Frame used to transmit the actual data of a CAN Object. The RTR bit is clear, and the data length indicates the number of data bytes in the frame.

**CAN frame** In addition to fields used for error detection/correction, a CAN frame consists of an arbitration ID, the RTR bit, a four-bit data length, and zero to eight bytes of data.

**CAN Network Interface Object** Within the NI-CAN Frame API, an object that encapsulates a CAN interface on the host computer.

**CAN Object** Within the NI-CAN Frame API, an object that encapsulates a specific CAN arbitration ID along with its raw data bytes.

**CAN remote frame** Frame used to request data for a CAN Object from a remote node; the RTR bit is set, and the data length indicates the amount of data desired (but no data bytes are included).

channel	Floating-point value in physical units (such as Volts, rpm, km/h, °C, and so on) that is converted to/from a raw value in measurement hardware. The Read and Write functions of the NI-CAN Channel API provide access to CAN channels. When a CAN message is received, NI-CAN converts raw fields in the message into physical units, which you then obtain using the Channel API Read function. When you call a Channel API Write function, you provide floating-point values in physical units, which NI-CAN converts into raw fields and transmits as a CAN message. For an example usage of the channel concept, refer to the Channel API section in Introduction.
Channel API	NI-CAN API that you use to read and write channels.
channel list	Input parameter of the CAN Init Start function. The channel list specifies the list of channels to read or write. For more information, refer to CAN Init Start.vi for LabVIEW, or nctInitStart for C.
ChannelList	<i>See</i> <a href="#">channel list</a> .
class	A set of objects that share a common structure and a common behavior.
clock drift	When two or more hardware products are used to measure a common system, you typically need to compare data from the hardware products simultaneously. Since each hardware product contains its own local oscillator to perform measurements, and all oscillators differ slightly in speed and tolerances, measurements on different hardware products can drift relative to one another. For example, if you measure the same sine wave on two different analog-input products, the measured sine waves typically drift out of phase after a few minutes. National Instruments products use RTSI to share timebases among different hardware products. Since the products share the same oscillator, clock drift is eliminated.
connection	With respect to networking, this term refers to an association between two or more nodes on a network that describes when and how data is transferred. With respect to RTSI, this term refers to a connection between two or more terminals.
controller	With respect to CAN, this term often refers to a CAN controller. With respect to real-time systems, this term refers to a device that receives input data and sends output data in order to hold one or more external, real-world variables at a certain level or condition. A thermostat is a simple example of a controller.

## D

Default Value	Property in the Channel API that specifies the default value for a channel. For more information, refer to CAN Get Property.vi for LabVIEW, or nctSetProperty for C.
device	See <a href="#">node</a> .
device network	Multi-drop digital communication network for sensors, actuators, and controllers.
DLL	Dynamic link library.
DMA	Direct memory access.

## E

error active	A CAN node is in error active state when both the receive and transmit error counters are below 128.
error counters	Every CAN node keeps a count of how many receive and transmit errors have occurred. The rules for how these counters are incremented and decremented are defined by the CAN protocol specification.
error passive	A CAN node is in error passive state when one or both of its error counters increment above 127. This state is a warning that a communication problem exists, but the node is still participating in network traffic.
extended arbitration ID	A 29-bit arbitration ID. Frames that use extended IDs are often referred to as CAN 2.0 Part B (the specification that defines them).

## F

FCC	Federal Communications Commission.
filepath	Complete path to a filename using Windows conventions, such as: C:\Program Files\National Instruments\NI-CAN\MyDatabase.ncd
frame	A unit of information transferred across a network from one node to another. From an OSI perspective, NI-CAN's usage of the term frame refers to a Data Link Layer unit, because individual fields are not specified.
Frame API	NI-CAN API that you use to read and write frames.



**H**

hex	Hexadecimal.
Hz	Hertz; cycles per second.

**I**

instance	An abstraction of a specific real-world thing; for example, John is an instance of the class Human. Also known as object.
interface	Reference to a specific CAN port in the NI-CAN software. NI-CAN interface names are assigned within MAX, and can range from CAN0 to CAN63. In the Channel API, the interface is specified during initialization of the task. For more information, refer to CAN Init Start.vi for LabVIEW, or nctInitStart for C. In the Frame API, the interface is specified during configuration of the CAN Network Interface Object. For more information, refer to ncConfigCANNet.vi for LabVIEW, or ncConfig for C.
Interface Baud Rate	Property in the Channel API that specifies the baud rate of the interface. For more information, refer to CAN Set Property.vi for LabVIEW, or nctSetProperty for C.
Interface Receive Error Counter	Every CAN node keeps a count of how many receive errors have occurred. The rules for how this counter is incremented and decremented are defined by the CAN protocol specification. This property in the Channel API returns the receive error counter. For more information, refer to CAN Get Property.vi for LabVIEW or nctGetProperty for C.
Interface Single Shot Transmit	Property in the Channel API that determines whether to retry failed frame transmissions or transmit as a single-shot. For more information, refer to CAN Set Property.vi for LabVIEW, or nctSetProperty for C.
Interface Transmit Error Counter	Every CAN node keeps a count of how many transmit errors have occurred. The rules for how this counter is incremented and decremented are defined by the CAN protocol specification. This property in the Channel API returns the transmit error counter. For more information, refer to CAN Get Property.vi for LabVIEW, or nctGetProperty for C.
ISO	International Standards Organization.

## K

**KB** Kilobytes of memory.

## L

**LabVIEW** Laboratory Virtual Instrument Engineering Workbench.

**local** Within NI-CAN, anything that exists on the same host (personal computer) as the NI-CAN driver.

**local wakeup** Wakeup of the CAN transceiver from sleep mode caused by the call to an NI-CAN function, such as setting Transceiver Mode to Normal.

**Low-speed CAN** Fault-tolerant CAN transceiver specification as defined in ISO 11898.

## M

**MAX** Measurement & Automation Explorer provides a centralized location for configuration of National Instruments hardware products. MAX also provides many useful tools for interaction with hardware.

**MB** Megabytes of memory.

**message** CAN data frame for which the individual fields are described. From an OSI perspective, NI-CAN usage of the term frame refers to a User Layer unit, because the Application Layer is assumed (simple peer-to-peer protocol), and the channel configurations specify User Layer meaning.

**method** An action performed on an instance to affect its behavior; the externally visible code of an object. Within NI-CAN, you use NI-CAN functions to execute methods for objects. Also known as service, operation, and action.

**minimum interval** For a given connection, the minimum amount of time between subsequent attempts to transmit frames on the connection. Some protocols use minimum intervals to guarantee a certain level of overall network performance.

**mode** Input parameter of the CAN Init Start function. The mode specifies the direction of data transfer (input or output), and the type of information provided (input or timestamped input). For more information, refer to CAN Init Start.vi for LabVIEW, or nctInitStart for C.

Mode	<i>See</i> <a href="#">mode</a> .
multi-drop	A physical connection in which multiple devices communicate with one another along a single cable.

## N

network interface	A physical connection of a node onto a network.
NI-CAN database	CAN database format defined by National Instruments. NI-CAN database files use the .ncd file extension.
NI-CAN driver	Device driver and/or firmware that implement all the specifics of a CAN network interface. Within NI-CAN, this software implements the CAN Network Interface Object as well as all objects above it in the object hierarchy.
node	A physical assembly, linked to a communication line (cable), capable of communicating across the network according to a protocol specification. Also known as device.
notification	Within NI-CAN, an operating system mechanism that the NI-CAN driver uses to communicate events to the application. You can think of a notification of as an API function, but in the opposite direction.

## O

object	<i>See</i> <a href="#">instance</a> .
object-oriented	A software design methodology in which classes, instances, attributes, and methods are used to hide all of the details of a software entity that do not contribute to its essential characteristics.
OSI	Open Systems Interconnection (OSI) is a collection of ISO standards for communication protocols. Most people reference OSI in the context of the layers that it specifies for all communication protocols. The Physical Layer refers to physical connectors, cabling, and signal characteristics. The Data Link Layer refers to the fundamental frame format. The Application Layer refers to connection establishment and other higher-level transactions between nodes. The User Layer is an informal term that refer to the definition of specific fields in Application Layer messages that define how an application uses the protocol.

## P

peer-to-peer	Network connection in which data is transmitted from the source to its destination(s) without need for an explicit request. Although data transfer is generally unidirectional, the protocol often uses low level acknowledgments and error detection to ensure successful delivery.
periodic	Connections that transfer data on the network at a specific rate.
polled	Request/response connection in which a request for data is sent to a device, and the device sends back a response with the desired value.
poly VI	LabVIEW VI that accepts different data types for a single input or output terminal. In some cases, the data type can be selected based on the value that you wire to the poly input or output. To select a specific poly VI type, right-click the VI, go to Select Type, and select the desired type. For more information, refer to the LabVIEW documentation. Like many other National Instruments APIs, the NI-CAN Channel API implements Read and Write as poly VIs in order to support a variety of data types.
polymorphic VI	See <a href="#">poly VI</a> .
port	The physical CAN connector on the NI-CAN hardware product. You assign an interface name to each port using MAX.
property	The Channel API provides properties to access configuration settings or other information. LabVIEW also uses the term property for settings of front panel controls and indicators. In the Frame API, the term attribute is used for similar settings.
property nodes	In LabVIEW, you can use property nodes to change the appearance or behavior of front panel controls and indicators. For example, you can change the label, minimum value, and maximum value of an indicator. For more information, refer to the LabVIEW documentation.
protocol	A formal set of conventions or rules for the exchange of information among nodes of a given network.

**R**

RAM	Random-access memory.
remote	Within NI-CAN, anything that exists in another node of the device network (not on the same host as the NI-CAN driver).
Remote Transmission Request (RTR) bit	This bit follows the arbitration ID in a frame, and indicates whether the frame is the actual data of the CAN Object (CAN data frame), or whether the frame is a request for the data (CAN remote frame).
remote wakeup	Wakeup of the CAN transceiver from sleep mode caused from an event on the network. A remote wakeup occurs when a remote node transmits a CAN frame (referred to as the wakeup frame). The wakeup frame wakes up the transceiver and CAN controller chip of the NI CAN interface. The wakeup frame is not received or acknowledged by the CAN controller chip. When the wakeup frame ends, the NI CAN interface enters Normal mode, and again receives and transmits CAN frames. If the node that transmitted the wakeup frame did not detect an acknowledgement (such as if other nodes were also waking), it will retry the transmission, and the retry will be received by the NI CAN interface. For a remote wakeup to occur for Single Wire transceivers, the node that transmits the wakeup frame must first place the network into the Single Wire Wakeup Transmission mode by asserting a higher voltage (typically 12 V).
request/response	Network connection in which a request is transmitted to one or more destination nodes, and those nodes send a response back to the requesting node. In industrial applications, the responding (slave) device is usually a sensor or actuator, and the requesting (master) device is usually a controller. Also known as master/slave.
resource	Hardware settings used by National Instruments CAN hardware, including an interrupt request level (IRQ) and an 8 KB physical memory range (such as D0000 to D1FFF hex).
RTSI	Real Time System Integration bus. National Instruments technology that can be used to synchronize multiple hardware products. For PCI products, this refers to the ribbon cable that is used to route signals between cards. For PXI products, the RTSI signals are provided on the backplane. For PCMCIA products, RTSI signals can be connected between the sync cable of a CAN card and the terminal block of a DAQ card.

## S

s	Seconds.
sample	A floating-point value that represents physical units. In the NI-CAN Channel API, you Read and Write samples using channels.
sample rate	Input parameter of the CAN Init Start function. The sample rate specifies whether to transfer data in a periodic or event-driven manner. For periodic behavior, the rate specifies the number of read/write samples to perform per second. For more information, refer to CAN Init Start.vi for LabVIEW, or nctInitStart for C.
SampleRate	See <a href="#">sample rate</a> .
sensor	A device that measures electrical, mechanical, or other signals from an external, real-world variable; in the context of device networks, sensors are devices that send their primary data value onto the network; examples include temperature sensors and presence sensors. Also known as transmitter.
Series 1	National Instruments hardware for CAN that shipped prior to NI-CAN 2.0. NI-CAN supports this hardware series, but some new features require Series 2 hardware.
Series 2	National Instruments hardware for CAN that shipped after NI-CAN 2.0. Improvements relative to Series 1 include a superior CAN controller (Philips SJA1000), and improved RTSI features.
signal	Term used by other vendors of CAN products to refer to a CAN channel. For National Instruments products, this term usually refers to a physical voltage that represents a predefined behavior. For example, RTSI connections are used to exchange signals.
standard arbitration ID	An 11-bit arbitration ID. Frames that use standard IDs are often referred to as CAN 2.0 Part A; standard IDs are by far the most commonly used.

**start trigger** When two or more hardware products are used to measure a common system, you typically need to compare data from the hardware products simultaneously. Since each hardware product starts its measurement independently, measurements on different hardware products can often be skewed in time relative to one another. For example, if you measure the same sine wave on two different analog-input products, the measured sine waves start off out of phase. National Instruments products use RTSI to share start triggers among different hardware products. Since the products share the same start trigger, measurements begin at the same time.

**synchronize** Connection of two or more hardware products in order to measure a common system. For National Instruments products, RTSI connections are used to synchronize. Although there are a variety of ways to synchronize National Instruments products, a common technique is to share a timebase and start trigger over RTSI in order to eliminate clock drift and startup skew.

## T

**task** A collection of channels that you can read or write. The task is returned as an output parameter of the CAN Init Start function, and is used for all subsequent Channel API calls such as Read or Write. For more information, refer to CAN Init Start.vi for LabVIEW, or nctInitStart for C.

**terminal** A physical pin on a hardware component. RTSI signals are one type of terminal. Internal connections within hardware products are another type of terminal.

**timebase** The fundamental clock used to perform measurement. National Instruments synchronization features allow the timebase of one product to be shared with another in order to eliminate clock drift.

**Timeout** Property in the Channel API that specifies the behavior the timeout in milliseconds for Read and Write functions. For more information, refer to CAN Set Property.vi for LabVIEW, or nctSetProperty for C.

## U

**unsolicited** Connections that transmit data on the network sporadically based on an external event. Also known as nonperiodic, sporadic, and event driven.

## **V**

VI Virtual Instrument.

## **W**

watchdog timeout A timeout associated with a connection that expects to receive network data at a specific rate. If data is not received before the watchdog timeout expires, the connection is normally stopped. You can use watchdog timeouts to verify that the remote node is still operational.

waveform data type LabVIEW data type that represents a sequential list of samples in time. The data type includes the array of samples (each a DBL), a start time that specifies when the first sample was measured, and a delay time that specifies the time between samples (sample rate) or more information, refer to the LabVIEW documentation. The Read and Write functions of the Channel API support the LabVIEW waveform data type.



# Index

---

## Numerics

9-pin D-SUB connector pinout, High-Speed  
(figure), 4-1, 4-7, 4-18, 4-22

## A

additional information, LIN, C-8

advanced frame types, LIN, C-7

API (Application Programming Interface)

Channel API

additional programming topics, 6-11

Get Names, 6-11

Set Property, 6-12

Synchronization, 6-11

basic programming model, 6-4

Clear, 6-10

Init Start, 6-5

Read, 6-6

Read Timestamped, 6-8

Read Timestamped (figure), 6-8

Write, 6-8

choose source of Channel

configuration, 6-1

decision process (figure), 6-1

using, 6-1

choose which API to use, 5-6

Frame API

choose which objects to use, 9-1

using CAN network interface

objects, 9-1

using CAN objects, 9-3

application development, 5-1

choose the programming language, 5-1

choose which API to use, 5-6

choose your programming language

Borland C++, 5-3

LabVIEW, 5-1

LabWindows/CVI, 5-2

Microsoft Visual Basic, 5-4

other programming languages, 5-4

Visual C++ 6, 5-2

## B

Borland C++, 5-3

bus timing, LIN, C-4

## C

cable length, Single Wire CAN, 4-20

cable lengths, High-Speed CAN, 4-4

cable termination, low-speed CAN, 4-10

cabling example

High-Speed CAN (figure), 4-6

Low-Speed/Fault-Tolerant CAN  
(figure), 4-17

Single Wire CAN (figure), 4-21

cabling requirements

LIN

lengths, 4-26

number of devices, 4-26

specifications, 4-26

termination, 4-26

Single Wire CAN, 4-20

XS CAN, 4-23

CAN

error detection and confinement, B-5

frame types, D-1

frames, B-3

history and use, B-1

identifiers and message priority, B-2

low-speed, B-8

summary of standard, B-1

CAN and LIN hardware installation, 2-3

- CAN Channels
  - example in MAX (figure), 2-5
  - overview, 2-4
- CAN Clear Multiple with NI-DAQ.vi, 7-10
- CAN Clear Multiple with NI-DAQmx.vi, 7-12
- CAN Clear with NI-DAQ.vi, 7-6
- CAN Clear with NI-DAQmx.vi, 7-8
- CAN Clear.vi, 7-4
- CAN Connect Terminals.vi, 7-14
- CAN Create Message.vi, 7-24
- CAN Create MessageEx.vi, 7-30
- CAN data frame fields example (figure), 1-10
- CAN Disconnect Terminals.vi, 7-37
- CAN for CompactRIO, 3-32
- CAN Get Names.vi, 7-39
- CAN Get Property.vi, 7-42
- CAN hardware
  - SJA1000 CAN controller, 3-1
- CAN identifiers and message priority, B-2
- CAN Init Start.vi, 7-59
- CAN Initialize.vi, 7-55
- CAN interface cables
  - cable lengths, 4-4
  - cable termination, low-speed CAN, 4-10
  - cabling example
    - High-Speed CAN (figure), 4-6
    - Low-Speed/Fault-Tolerant CAN (figure), 4-17
  - PCI-CAN cable (figure), 4-19
  - PCMCIA-CAN cable (figure), 4-3
  - PCMCIA-CAN/LS cable
    - figure, 4-8
    - termination resistors, 4-16
  - pinout for 9-pin D-SUB connector,
    - High-Speed (figure), 4-1, 4-7, 4-18, 4-22
  - termination resistor placement
    - figure, 4-5
    - low-speed CAN, 4-10
- CAN Network Interface Objects, possible uses, 9-1
- CAN Objects
  - choosing NI-CAN Objects
    - CAN Network interface Objects, 9-1
    - CAN Objects, 9-3
  - using, 9-3
- CAN overview, 1-1
- CAN ports, configuring, 2-4
- CAN Read.vi, 7-65
- CAN Set Property.vi, 7-73
- CAN Start.vi, 7-88
- CAN Stop.vi, 7-90
- CAN Sync Start Multiple with NI-DAQ.vi, 7-97
- CAN Sync Start Multiple with NI-DAQmx.vi, 7-100
- CAN Sync Start with NI-DAQ.vi, 7-92
- CAN Sync Start with NI-DAQmx.vi, 7-94
- CAN Write.vi, 7-103
- CE compliance specifications, E-13
- CE compliance, specifications, E-13
- Channel API
  - additional programming topics, 6-11
    - Get Names, 6-11
    - Set Property, 6-12
    - Synchronization, 6-11
  - basic programming model, 6-4
    - Clear, 6-10
    - Init Start, 6-5
    - Read, 6-6
    - Read Timestamped, 6-8
    - Read Timestamped (figure), 6-8
    - Write, 6-8
  - choose source of Channel configuration, 6-1
    - decision process (figure), 6-1
  - overview, 1-10
  - using, 6-1
- checksum
  - CRC, 10-44, 10-97, 11-50, 11-86
- common questions, A-3

- configuration of LabVIEW RT
  - CompactRIO system, 2-6
  - overview, 2-5
  - PXI system, 2-6
- configure CAN and LIN ports, 2-4
- connector pinout
  - PCI and PXI
    - Single Wire CAN, 4-17
    - XS CAN, 4-21
  - PCI, PXI, and USB
    - High-Speed CAN, 4-1
    - Low-Speed/Fault-Tolerant CAN, 4-6
  - PCMCIA
    - High-Speed CAN, 4-2
    - Low-Speed/Fault-Tolerant CAN, 4-8
  - PCMCIA-CAN
    - High-Speed CAN, 4-19
  - USB-LIN
    - LIN, 4-24
- connectors and cables
  - LIN, 4-24
  - Low-Speed/Fault-Tolerant CAN, 4-6
  - Single Wire CAN, 4-17
  - XS CAN, 4-21
- cyclic redundancy check (CRC), B-4

## D

- data length code (DLC), B-4
- data types for Channel API for C, 8-1
- differences between CAN and LIN, 9-30
- documentation
  - NI resources, G-1
  - related documentation, *xix*

## E

- electromagnetic compatibility, E-12
- electromagnetic compatibility
  - specifications, E-12
- environmental management
  - specifications, E-13

- error detection and confinement
  - CAN, B-5
  - LIN, C-6
- example of CAN data frame fields
  - (figure), 1-10

## F

- Frame API
  - additional programming topics, 9-25
  - basic programming model for CAN, 9-4, 9-7
  - choose which objects to use, 9-1
  - overview, 1-10
  - using, 9-1
  - using CAN network interface objects, 9-1
  - using CAN objects, 9-3
- frame format, LIN, C-1
- frame to channel conversion, 6-12
- frame types for CAN and LIN hardware, D-1
- frames, CAN, B-3

## H

- help, technical support, G-1
- High-Speed CAN
  - cabling requirements, 4-4
  - PCI, PXI, and USB connector pinout, 4-1
  - PCMCIA connector pinout, 4-2
  - PCMCIA-CAN connector pinout, 4-19
- history and use of
  - CAN, B-1
  - LIN, C-1

## I

- installation and configuration
  - safety instructions, 2-1
  - tools, 2-7
  - using NI-CAN with NI-DNET, 2-7

**L**

- LabVIEW, 5-1
- LabVIEW real-time (RT) configuration
  - CompactRIO system, 2-6
  - overview, 2-5
  - PXI system, 2-6
- LabWindows/CVI, 5-2
- LIN
  - additional information, C-8
  - advanced frame types, C-7
  - bus timing, C-4
  - cabling requirements, 4-26
    - lengths, 4-26
    - number of devices, 4-26
    - specifications, 4-26
    - termination, 4-26
  - connectors and cables, 4-24
  - error detection and confinement, C-6
  - frame format, C-1
  - frame types, D-1
  - history and use, C-1
  - overview, 1-2
  - sleep and wakeup, C-6
  - summary of standard, C-1
  - topology and behavior, C-5
  - USB-LIN connector pinout, 4-24
- LIN Checksum Type, 10-44, 10-97, 11-50, 11-86
- LIN ports, configuring, 2-4
- list of C Channel functions, 8-2
- list of C Frame functions, 11-3
- list of LabVIEW VIs, 7-1, 10-2
- low-speed CAN, B-8
  - preparing lead wires of, (figure), 4-16
  - replacing termination resistors, 4-15
  - termination resistors, 4-10
  - termination resistors, location of (figure), 4-15

**Low-Speed/Fault-Tolerant CAN**

- cabling requirements, 4-9
- connectors and cables, 4-6
- PCI, PXI, and USB connector pinout, 4-6
- PCMCIA connector pinout, 4-8

**M**

- master task, C-1
- MAX overview, 1-9, 2-3
- mode dependent channels, definition, 6-23

**N**

- ncAction, 11-5
- ncAction.vi, 10-4
- ncClose.vi, 10-8
- ncCloseObject, 11-8
- ncConfig, 11-9
- ncConfigCANNet.vi, 10-10
- ncConfigCANNetRTSI.vi, 10-15
- ncConfigCANObj.vi, 10-19
- ncConfigCANObjRTSI.vi, 10-27
- ncConnectTerminals, 11-30
- ncConnectTerminals.vi, 10-32
- ncCreateNotification, 11-40
- ncDisconnectTerminals, 11-45
- ncDisconnectTerminals.vi, 10-41
- ncGetAttr.vi, 10-43
- ncGetAttribute, 11-47
- ncGetHardwareInfo, 11-62
- ncGetHardwareInfo.vi, 10-58
- ncGetTimer.vi, 10-63
- ncOpen.vi, 10-65
- ncOpenObject, 11-67
- ncRead, 11-69
- ncReadMult, 11-82
- ncReadNet.vi, 10-68

ncReadNetMult.vi, 10-79  
 ncReadObj.vi, 10-90  
 ncReadObjMult.vi, 10-93  
 ncSetAttr.vi, 10-96  
 ncSetAttribute, 11-84  
 ncStatusToString, 11-113  
 nctClear, 8-4  
 nctConnectTerminals, 8-5  
 nctCreateMessage, 8-15  
 nctCreateMessageEx, 8-20  
 nctDisconnectTerminals, 8-26  
 nctGetNames, 8-28  
 nctGetNamesLength, 8-31  
 nctGetProperty, 8-33  
 nctInitialize, 8-44  
 nctInitStart, 8-47  
 nctRead, 8-53  
 nctReadTimestamped, 8-57  
 nctSetProperty, 8-60  
 nctStart, 8-75  
 nctStop, 8-76  
 nctWrite, 8-77  
 ncWaitForState, 11-116  
 ncWaitForState.vi, 10-125  
 ncWrite, 11-119  
 ncWriteMult, 11-127  
 ncWriteNet.vi, 10-129  
 ncWriteNetMult.vi, 10-137  
 ncWriteObj.vi, 10-149  
 NI CAN hardware overview, 1-2  
 NI-CAN hardware, compatibility with  
     NI-XNET, F-1  
 NI-CAN software  
     Channel API, 1-10  
     Frame API, 1-10  
     MAX, 1-9  
     overview, 1-9  
     tools, 2-7  
 NI-XNET Compatibility Library for NI-CAN  
     broken compatibility tables, F-3  
     Channel API for C, F-7

    Channel API for LabVIEW, F-4  
     Frame API for C, F-9  
     Frame API for LabVIEW, F-5  
     installation and configuration, F-1  
     limitations, F-3  
     overview and purpose, F-1  
 number of devices  
     Low-Speed/Fault-Tolerant CAN, 4-10  
     Single Wire CAN, 4-20

## O

online product certification  
     specifications, E-13  
 optical isolation, E-5  
 overview of  
     CAN, 1-1  
     LIN, 1-2  
     NI-CAN software, 1-9

## P

PCI-CAN  
     bus power requirements, 3-2  
     high-speed physical layer, 3-2  
     list of hardware, *xvii*  
     low-speed/fault-tolerant physical  
         layer, 3-4  
         bus power requirements, 3-5  
         transceiver, 3-4  
         VBAT jumper, 3-5  
         VBAT jumper settings, 3-6  
         VBAT jumper settings (figure), 3-6  
     overview, 3-2  
     RTSI, 3-9  
         architecture (figure), 3-10  
     single wire physical layer, 3-7  
         bus power requirements, 3-7  
         transceiver, 3-7  
         VBAT jumper, 3-8  
     specifications, E-1

- transceiver, 3-2
  - VBAT jumper, 3-2
  - VBAT jumper settings (figure), 3-3
  - XS software selectable physical layer, 3-8
  - PCI-CAN series card
    - PCI-CAN cable (figure), 4-19
  - PCMCIA-CAN
    - high-speed cables, 3-20
      - bus power requirements, 3-20
      - transceiver, 3-20
    - list of hardware, *xvii*
    - low-speed/fault-tolerant cables, 3-21
      - bus power requirements, 3-21
      - transceiver, 3-21
    - overview, 3-20
    - single wire cables, 3-22
      - bus power requirements, 3-22
      - synchronization, 3-23
        - architecture (Figure), 3-24
      - transceiver, 3-22
    - specifications, E-7
  - PCMCIA-CAN series card
    - PCMCIA-CAN cable (figure), 4-3
  - PCMCIA-CAN/LS series card
    - PCMCIA-CAN/LS cable
      - figure, 4-8
      - replacing termination resistors, 4-16
  - pinout for 9-pin D-SUB connector
    - High-Speed (figure), 4-1, 4-7, 4-18, 4-22
  - programming
    - choosing NI-CAN Objects
      - CAN Network Interface Objects, 9-1
      - CAN Objects, 9-3
    - languages, other (applications development), 5-4
  - PXI-8460
    - replacing termination resistors, 4-15
    - termination resistors
      - location of, (figure), 4-15
      - preparing lead wires of, (figure), 4-16
  - PXI-846x
    - list of hardware, *xvii*
    - specifications, E-4
  - PXI-847x
    - high-speed physical layer, 3-11
      - bus power requirements, 3-11
      - transceiver, 3-11
      - VBAT jumper, 3-11
      - VBAT jumper settings (Figure), 3-12
    - low-speed/fault-tolerant physical layer, 3-13
      - bus power requirements, 3-13
      - transceiver, 3-13
      - VBAT jumper, 3-14
      - VBAT jumper settings (Figure), 3-14
    - overview, 3-11
    - PXI trigger bus (RTSI), 3-18
      - figure, 3-19
    - single wire physical layer, 3-15
      - bus power requirements, 3-16
      - transceiver, 3-15
      - VBAT jumper, 3-16
    - XS software selectable physical layer, 3-16
- ## R
- related documentation, *xix*
  - resistance, determining termination, 4-10
  - resistor
    - termination
      - High-Speed CAN (figure), 4-5
      - location on PCI-CAN/LS2 board (figure), 4-14
      - low-speed CAN (figure), 4-10
      - preparing lead wires of replacement
        - PCI-CAN/LS2 (figure), 4-14
        - PCMCIA-CAN/LS cable (figure), 4-16

- replacing
  - low-speed CAN, 4-15
  - PCI-CAN/LS board, 4-13
  - PCMCIA-CAN/LS cable, 4-16
  - software selectable, 4-13
- RT configuration
  - CompactRIO system, 2-6
  - overview, 2-5
  - PXI system, 2-6

## S

- safety
  - information, 2-1
- safety specifications, E-12
- section headings for Channel API for C, 8-1
- Series 2 and Series 1
  - differences, 1-4
  - hardware series displayed in MAX (figure), 1-6
  - PCI and PXI, 1-6
  - PCI-CAN labels (figure), 1-4
  - PCMCIA cables, 1-7
  - PCMCIA hardware, 1-7
  - PCMCIA-CAN cables (figure), 1-5
  - PCMCIA-CAN labels (figure), 1-5
  - PXI-CAN labels (figure), 1-4
- Series 2 hardware overview, 1-2
- simplified CAN data frame, 1-1
- Single Wire CAN
  - cable length, 4-20
  - cabling example (figure), 4-21
  - cabling requirements, 4-20
  - connectors and cables, 4-17
  - number of devices, 4-20
  - PCI and PXI connector pinout, 4-17
  - termination, 4-20
- SJA1000 CAN controller overview, 3-1
- slave task, C-1
- sleep and wakeup, LIN, C-6
- software
  - application development, 5-1
  - choose the programming language, 5-1
  - choose which API to use, 5-6
  - choose your programming language
    - Borland C++, 5-3
    - LabVIEW, 5-1
    - LabWindows/CVI, 5-2
    - Microsoft Visual Basic, 5-4
    - other programming languages, 5-4
    - Visual C++ 6, 5-2
- specifications
  - CE compliance, E-13
  - electromagnetic compatibility, E-12
  - environmental management, E-13
  - online product certification, E-13
  - PCI-CAN, E-1
  - PCI-CAN Series 2
    - High-Speed CAN, E-2
    - Low-Speed/Fault-Tolerant CAN, E-2
    - operating environment, E-1
    - optical isolation, E-2
    - physical, E-1
    - power requirement, E-1
    - RTSI, E-2
    - Single Wire CAN, E-3
    - storage environment, E-2
    - XS Software Selectable, E-3
  - PCMCIA-CAN Series 2
    - High-Speed transceiver cable, E-9
    - Low-Speed/Fault-Tolerant transceiver cable, E-9
    - operating environment, E-8
    - optical isolation, E-8
    - physical, E-7
    - power requirement, E-7
    - single-wire cable, E-9
    - storage environment, E-8
    - synchronization triggers, E-8

- PXI-846x Series 2
  - functional shock, E-5
  - High-Speed CAN, E-5
  - Low-Speed/Fault-Tolerant CAN, E-6
  - operating environment, E-4
  - physical, E-4
  - power requirement, E-4
  - PXI trigger bus, E-5
  - random vibration, E-5
  - Single Wire CAN, E-6
  - storage environment, E-4
  - XS Software Selectable, E-7
- safety, E-12
- USB-CAN, E-10
  - High-Speed CAN, E-11
  - LIN, E-12
  - Low-Speed/Fault-Tolerant CAN, E-11
  - operating environment, E-10
  - optical isolation, E-11
  - physical, E-10
  - power requirement, E-10
  - storage environment, E-10
  - synchronization triggers, E-11
- USB-LIN, E-10
  - High-Speed CAN, E-11
  - LIN, E-12
  - Low-Speed/Fault-Tolerant CAN, E-11
  - operating environment, E-10
  - optical isolation, E-11
  - physical, E-10
  - power requirement, E-10
  - storage environment, E-10
  - synchronization triggers, E-11
- Waste Electrical and Electronic Equipment (WEEE), E-13
- summary of the CAN standard, B-1
- summary of the LIN standard, C-1
- support, technical, G-1

## T

- technical support, G-1
- termination resistance, determining, 4-10
- termination resistor
  - location of, low-speed CAN (figure), 4-15
  - location on PCI-CAN/LS2 board (figure), 4-14
  - placement figure, 4-5
  - placement for low-speed CAN (figure), 4-10
  - preparing lead wires
    - PCMCIA-CAN/LS cable replacement (figure), 4-16
  - preparing lead wires of replacement PCI-CAN/LS (figure), 4-14
  - preparing lead wires of, low-speed CAN (figure), 4-16
  - replacing
    - PCI-CAN/LS board, 4-13
    - PCMCIA-CAN/LS cable, 4-16
    - software selectable, 4-13
- termination, Single Wire CAN, 4-20
- tools for installation and configuration, 2-7
- topology and behavior, LIN, C-5
- troubleshooting
  - test failures, A-2
  - with MAX, A-1

## U

- USB-847x
  - CAN hardware, 1-8
  - LIN hardware, 1-9
  - overview, 1-8
- USB-CAN
  - high-speed physical layer, 3-25
    - bus power requirements, 3-26
    - LED indicators, 3-26, 3-28, 3-29
    - transceiver, 3-26
  - list of hardware, xviii



- low-speed/fault-tolerant physical layer, 3-27
  - bus power requirements, 3-27
  - transceiver, 3-27
- overview, 3-25
- specifications, E-10
  - High-Speed CAN, E-11
  - LIN, E-12
  - Low-Speed/Fault-Tolerant CAN, E-11
  - operating environment, E-10
  - optical isolation, E-11
  - physical, E-10
  - power requirement, E-10
  - storage environment, E-10
  - synchronization triggers, E-11
- USB-LIN, 3-28
  - bus power requirements, 3-28
  - list of hardware, *xviii*
  - overview, 3-28
  - specifications, E-10
    - High-Speed CAN, E-11
    - LIN, E-12
    - Low-Speed/Fault-Tolerant CAN, E-11
    - operating environment, E-10
    - optical isolation, E-11
    - physical, E-10
    - power requirement, E-10
    - storage environment, E-10
    - synchronization triggers, E-11
  - synchronization in USB-CAN/LIN devices, 3-29
  - transceiver, 3-28
- using NI-CAN with NI-DNET, 2-7
- using NI-CAN with NI-DNET software tools, 2-7

## V

- verifying installation of CAN and LIN hardware, 2-3
- virtual bus timing, 6-16
- Visual C++ 6, 5-2

## W

- Waste Electrical and Electronic Equipment (WEEE) specifications, E-13
- Web resources, G-1

## X

### XS CAN

- cabling requirements, 4-23
- connectors and cables, 4-21
- external transceiver example (figure), 4-24
- PCI and PXI connector pinout, 4-21